

marantz®

**Model 2252 B
Stereophonic
Receiver**

MARANTZ CO., INC. 20525 NORDHOFF STREET, CHATSWORTH, CALIFORNIA 91311
A WHOLLY-OWNED SUBSIDIARY OF SUPERSCOPE INC., CHATSWORTH, CALIFORNIA 91311

FOREWORD

For optimum performance and enjoyment from your Model 2252B Stereo Receiver, please study these instructions carefully. Installation and operation are not complicated, but its flexibility and features deserve your becoming familiar with its controls and connections.

This manual is divided into two parts. The first covers installation and operation in simple, non-technical language. The second describes the 2252B in more detail with functional explanations. For quick identification of the controls and connections, references to them are printed in **BOLDFACE TYPE**, exactly as they appear on the front and rear panels of your Receiver.

AC Line Operation

WARNING: TO PREVENT FIRE OR SHOCK HAZARD, DO NOT EXPOSE THIS APPLIANCE TO RAIN OR MOISTURE.

GENERAL DESCRIPTION

The Marantz Model 2252B is an all solid state receiver incorporating the innovative design and unparalleled technology that have made Marantz famous in the audio component industry.

The Model 2252B features a sensitive stereo FM tuner, a highly selective AM tuner, and a low distortion preamplifier and amplifier on a single chassis. The FM tuner features a front end which employs a dual gate MOSFET and FM IF unit, a phase locked loop multiplex decoder and an AM tuner, all of which utilize IC's throughout. The amplifier sections permit the connection of two stereo pairs of loudspeakers, a turntable or record changer, two tape recorders, stereo headphones, and an auxiliary source such as an additional tuner or a TV sound source. The 2252B also features a front panel dubbing jacks.

AFTER UNPACKING

It is advisable to retain all original packing material to prevent damage should you wish to transport or ship the Model 2252B (refer to page 16 for repacking and shipping instructions). Be careful that you do not inadvertently throw away or lose the parts packed with the unit.

Please inspect your Model 2252B carefully for any signs of shipping damage. Our very strict quality control and professional pride ensure that each Model 2252B left the factory in perfect condition. If the unit is damaged or fails to operate, immediately notify your dealer. If the unit was shipped to you directly, notify the transportation company without delay. Only you, the consignee, may institute a claim against the carrier for shipping damage. Save the carton and all packing material as evidence of damage for their inspection. Should assistance be required, the Marantz Company will cooperate fully in assisting your claim.

Please fill out and mail the Warranty Registration Card within ten days of purchase. The card will remain on file at the Marantz Company for the duration of the warranty period. We also strongly advise that you retain your sales receipt to provide proof of purchase in the event that warranty service is sought.

TABLE OF CONTENTS

PREPARATION FOR USE	1	Recording Dolbyized FM Programs	12
Mechanical Installation	1	TECHNICAL DESCRIPTION	12
Marantz Walnut Veneer Cabinet	1	General	12
Custom Installation	1	FM Front End	12
CONNECTING THE MODEL 2252B	1	FM IF Amplifier	12
Phono Inputs	1	FM Stereo Demodulator	13
Tape Monitor Jacks	2	Muting Circuit	13
Aux Inputs	2	AM Tuner	13
FM Antenna	2	Selector Switch	13
Outdoor FM Antennas	2	Phono EQ Amplifier	13
AM Antenna	3	Mono Functions	13
FM Quadradial Output Jack	3	Control Circuits	13
Pre Out and Main In Jacks	3	Balance Control	13
Speaker Systems	4	Volume Control	13
Speaker Phasing	4	Tone Control Amplifier	14
Connection to AC Outlet	5	Amplifier	14
Convenience Outlets	5	MAINTENANCE	15
AC Protector Fuse	5	Cleaning	15
Dolby PLUG-IN FM Decoder Installation	5	Fuse Replacement	15
Signal Connections Checklist	5	In Case of Difficulty	15
SIMPLIFIED OPERATING PROCEDURES	6	SERVICE NOTES	16
MAIN CONTROLS AND SWITCHES	6	Repairs	16
Power Switch	6	Repacking for Shipment	16
Selector Switch	6		
Volume Control	6		
Balance Control	6		
Bass, Mid and Treble Controls	7		
Tuning Meter	7		
Gyro-Touch Tuning Control	7		
AM	7		
FM	7		
FM-25 μ S Switch — Dolby FM Reception	7		
Speaker System Switches	7		
Phones Jack	8		
FM Muting Switch	8		
Loudness Switch	8		
Hi Filter Switch	8		
Mono Switch	8		
Tape Monitor Switches	8		
Tape Monitor Switches, Tape Copy Switches and Dubbing Jacks	8		
USING TAPE RECORDERS WITH YOUR MODEL 2252B	9		
Dubbing Jacks	9		
Tape Monitoring	9		
Making Tape Recordings	9		
How To Make Tape-to-Tape Copies	9		
Making Modified Tape Recordings	9		
		LIST OF ILLUSTRATIONS	
		1. Rear Panel Connection Facilities	1
		2. FM Antenna Connection	2
		3. AM Ferrite-rod Antenna	2
		4. Loudspeaker System Connections	4
		5. Front Panel Controls and Jack	6
		6. Stereophone Plug	8
		7. Tape Recorder Connections	10
		8. Functional Block Diagram	11
		9. Packing Instructions	16

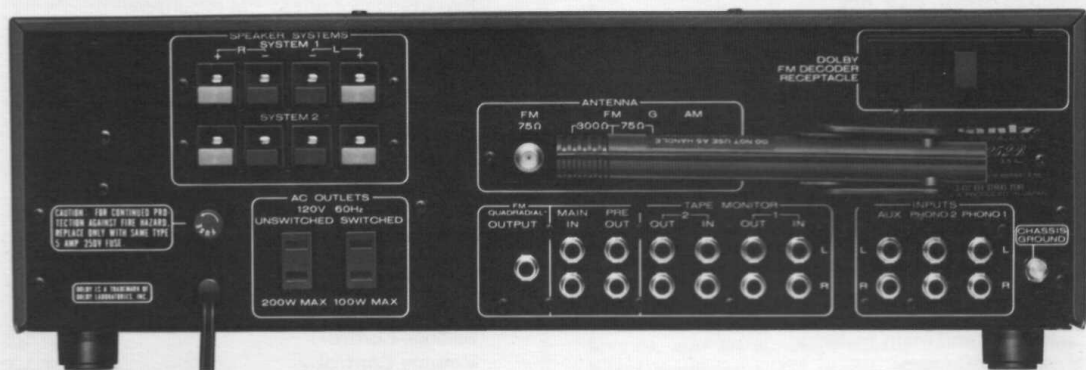

Figure 1 Rear Panel Connection Facilities

PREPARATION FOR USE

• MECHANICAL INSTALLATION

The Model 2252B Stereo Receiver can be installed in two basic ways:

In a beautiful walnut veneer cabinet for placement on a table or shelf, or mounted in your own cabinetry or custom installation.

• MARANTZ WALNUT VENEER CABINET

An attractive walnut veneer cabinet, Model WC-122, may be obtained from your Marantz dealer. The case provides for proper ventilation, and can be placed on furniture, or on a bookshelf. Complete instructions for installation are provided with the WC-122.

• CUSTOM INSTALLATION

When planning a custom installation, allow adequate spacing between the Model 2252B cabinet surfaces, and other components for adequate ventilation.

To install the Model 2252B Stereo Receiver in a custom cabinet, cut an opening 16-7/8 inches wide by 5-1/8 inches high. Since the front panel of the Model 2252B is larger than the cutout, it will neatly hide the edges of the cut. Remove the plastic feet from the bottom of the unit and slide it through the opening. To support the weight of the Model 2252B, adequate bracing across the rear of the cabinet must be located to provide contact with the rear of the unit.

CONNECTING THE MODEL 2252B

Figure 1 shows the location of input and output jacks on the rear panel. These jacks are for "permanent" connections. Front panel jacks and their use will be discussed later.

All connections to the rear panel should be made with the power to the entire system turned off. The rear panel signal connections are arranged in stereo pairs. All signal connections to the Model 2252B, with the exception of the FM antenna and loudspeakers, should be made with shielded audio cables. To avoid confusion, connect one cable at a time between the 2252B and the other components of your system. This is the safest way to avoid cross-connecting channels or confusing signal sources with destinations.

• PHONO INPUTS

The phono jacks are intended for use with magnetic phono cartridges and have a 47,000 ohm input impedance.

If a hum is heard when playing records, this is an indication that the record player or its connections are incorrectly grounded. Connect a separate ground wire from the turntable or record changer from to the CHASSIS GROUND binding post of the Model 2252B. If this is ineffective, try reversing the polarity of the turntable's power plug.

If hum persists, consult the instruction booklets for the turntable and/or phono cartridge.

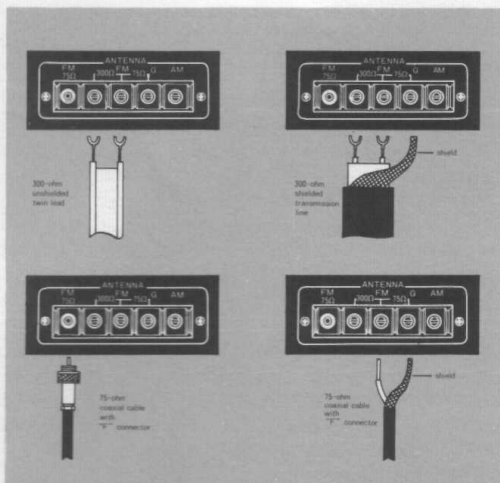

Figure 2 FM Antenna Connection

• TAPE MONITOR JACKS

The rear panel of the Model 2252B can accommodate two tape recorders.

The terms IN and OUT refer to the input and output of the Model 2252B. Therefore, the IN jacks on the Model 2252B accept signals from the line outputs of each tape recorder; the OUT jacks feed signal to the tape recorder's inputs.

• AUX INPUTS

The AUX INPUT jacks are for miscellaneous high level signal sources such as additional tuners and/or receivers, tape players, phonographs that provide RIAA equalized high level output, TV sound outputs and other external components.

• FM ANTENNA

Included in the accessory kit is a ribbon-type "folded dipole" FM antenna. This type of antenna is simple and practical and will give adequate results in primary signal areas. To use it, unfold it into a "T" shape and connect its leads to the terminals marked "300 Ω" on the back of the receiver (See Figure 2). The antenna is designed to operate in a horizontal position. Temporarily (for the purpose of getting started) attach it to a nearby wall.

As shown in Figure 2, the Model 2252B is also capable of accommodating other types of cable, including 75-ohm coaxial cable (with or without "F"-type connector), and 300-ohm shielded transmission line. These types of cable are for use

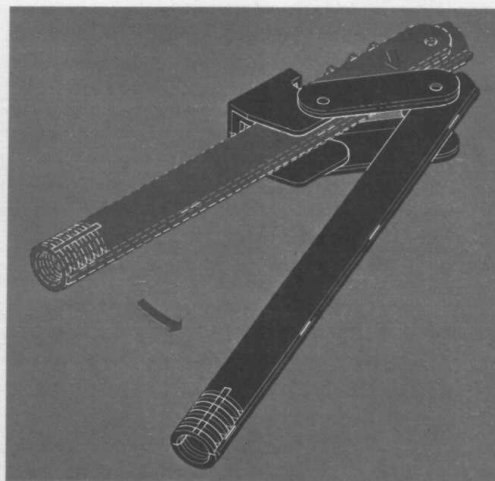

Figure 3 AM Ferrite-rod Antenna

with outdoor antennas, which will be discussed next.

• OUTDOOR FM ANTENNAS

As stated before, the supplied folded dipole antenna will give satisfactory results in primary signal areas. It should be obvious, however, that if you are located in a fringe area where signals are weak, then an outdoor antenna will be necessary. Even if you live in a strong signal location, an outdoor directional antenna may be needed to eliminate "multipath" reflections.

Multipath reflections are responsible for much of the distortion and sibilance associated with poor FM reception. They occur when radio waves from the transmitter bounce off of nearby mountains and tall buildings. The reflected waves follow different, more roundabout paths to your tuner and arrive slightly delayed and out of phase with the direct signal (hence the term "multipath"). This causes distortion in the same manner that "ghost" images are generated on television.

The way to minimize multipath is to use a "beam type" antenna that can be aimed toward the FM transmitter and away from the multipath reflections. The best types of antennas to use are either a "Yagi" or "Log-Periodic" configuration with six or more elements designed expressly for FM reception.

If you want to receive stations from more than one general direction, then you will need a good quality antenna rotor system. This will enable you to point the antenna in the direction giving

the least multipath interference, by means of a control box located near the tuner.

Another important factor is the type of lead-in wire to use. Unshielded lead-in wires, such as 300-ohm twin lead, can act as an omnidirectional antenna, and can cancel the directional benefits of your antenna. Therefore, we recommend using a balanced, shielded 300-ohm cable or a coaxial 75-ohm cable with a 300-to-75-ohm matching transformer at the antenna. These types of shielded cable effectively prevent the lead-in from contributing to multipath distortion.

Shielded antenna cable will be available at the same store where you buy your antenna. If you decide to use 75-ohm coaxial cable, we recommend buying cable with "F"-type connectors attached. These will fit both the matching transformer and the terminal on the Model 2252B (See Figure 2).

It is considered good practice to connect the antenna mast to an earth ground, both for reasons of safety and noise reduction. If 300-ohm shielded cable is used, connect the shield to ground (G) at the tuner end only.

For rural areas, it is recommended to consult a local dealer about installation and lightning arrester protection.

We don't recommend using master antenna systems, such as those found in apartment buildings. Such systems are usually designed expressly for television reception and frequently suppress or reduce the quality of the FM signals before distribution.

Where outdoor antennas are prohibited or inconvenient, the simplest form of "rabbit-ear" TV antenna is the most practical and will give satisfactory results. This type is preferred over the folded dipole because it can be more readily rotated for the best reception.

● AM ANTENNA

Your Tuner is equipped with an AM ferrite-rod antenna. BEFORE USING THE MODEL 2252B, SWING THE ANTENNA OUT AS SHOWN IN FIGURE 3.

The ferrite-rod antenna will give you satisfactory results in primary signal areas. However, an outdoor antenna will provide better reception in weaker signal areas. Two single wires are required to make an AM outdoor antenna. First, connect one end of a single wire to the **AM ANTENNA** terminal on the rear panel, and the other end to a very high horizontal antenna wire of 25 to 75 feet in length suspended between insulators in an outdoor location (the higher the better). Next, connect the second single wire between the **G** terminal of your Model 2252B and an authenticated earth ground (such as a metal water pipe).

● FM QUADRADIAL OUTPUT JACK

In anticipation of future four channel quadrasonic broadcasting, your Model 2252B is equipped with an **FM QUADRADIAL OUTPUT** jack. The signal available at this jack is the unequalized buffered output of the FM discriminator. Its level, frequency response characteristics, and output impedance are ideal to drive a four channel adaptor. This jack can also be used as a simple "white noise" generator for checking the response characteristics of loudspeakers and amplifiers. For this application, connect the **FM QUADRADIAL OUTPUT** jack to the **TAPE 1** input jack, press the **TAPE 1 MONITOR** switch, place the Model 2252B in FM mode with the muting off and tune between FM stations to receive interstation noise.

● PRE OUT AND MAIN IN JACKS

The **PRE OUT** jacks deliver the output of the Model 2252B preamplifier circuits to the rear panel. The **MAIN IN** jacks are the input terminals of the power amplifier section of the Model 2252B. The **PRE OUT** and **MAIN IN** jacks are bridged internally by special contacts within the jack assembly. When you wish to use such equipment as a graphic equalizer, compressor/limiter, or expander, you may connect these instruments to your Model 2252B with appropriate lengths of shielded audio cables. When the external equipment is connected, the insertion of its RCA phono plugs in to the **MAIN IN** jacks automatically breaks the internal connections to prevent the external equipment from being bypassed.

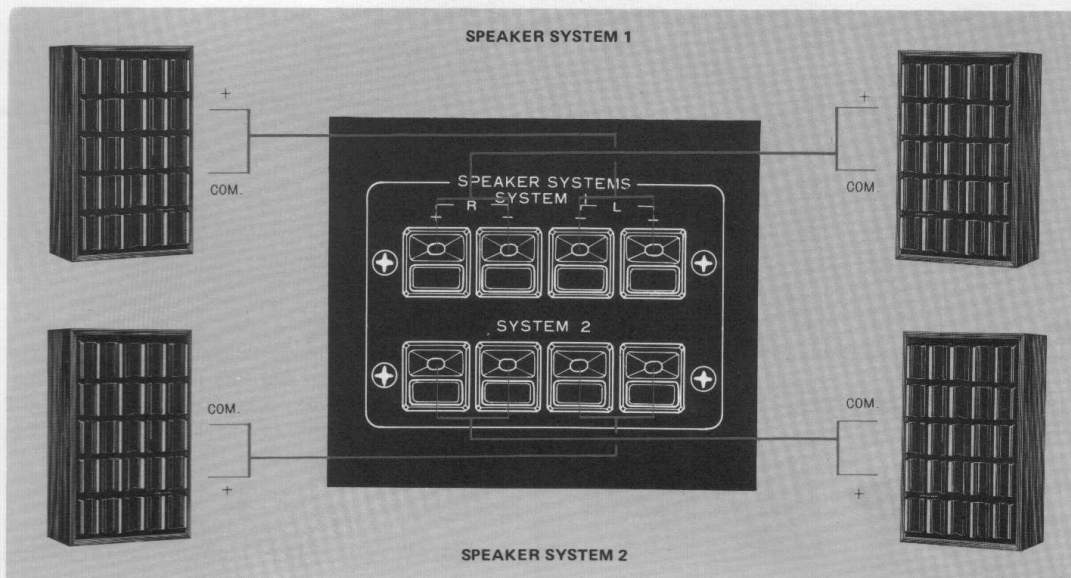

Figure 4 Loudspeaker System Connections

● SPEAKER SYSTEMS

The **SPEAKER SYSTEMS** terminals on the rear panel can accommodate two stereo pairs of loudspeakers. Connect the main pair to the **SYSTEM 1** terminals. The **SYSTEM 2** terminals are for a second stereo pair of loudspeakers (see Figure 4). Selection of loudspeaker systems is made with the **SPEAKER SYSTEM** pushswitches on the front panel.

To connect the speakers to the 2252B, use ordinary #18 gauge two conductor lamp cord. For distances longer than 30 feet, use #16 gauge wire or heavier.

● SPEAKER PHASING

To assure the best stereo separation and frequency response, the speakers must be properly phased. The positive terminal on each speaker should be connected to its respective (+) terminal on the Model 2252B, and the negative or "common" terminal should be connected to its respective (-) terminal. To verify that a pair of speakers are correctly phased, perform the following test:

1. Complete the necessary signal connections so that program material may be played through the speakers.
2. Place the speakers in the center of the room.
3. Depress the **MONO** pushswitch and play a

record (or radio or tape) with strong bass tones at a low volume level. Center the **BALANCE** control.

4. Position the speakers about six inches apart, face-to-face. Listen, particularly to the apparent loudness of the bass tones.
5. Next, turn off all power, but do not disturb the **VOLUME** or **BALANCE** settings. Reverse the connections on the right speaker only. Turn on the power and listen again. If the bass tones now seem louder than in (4), you have corrected the phasing between the speakers. If the bass notes now sound softer, turn off the power and reconnect the speakers as they had been originally.
6. If an additional pair of speakers is used along with the system 1 speaker system, check phasing between the system 2 speakers and the system 1 speakers. Use the **BALANCE** control to play only two speakers at once, and invert the wiring on the system 2 speakers as necessary. Do not change the connections on the system 1 speaker system.
7. Once having phased all speakers, you need not repeat this procedure in the future if you now mark the speaker connections and/or cables. Any method of coding is satisfactory, provided it enables you, in the future, to duplicate your now-correct hookup between speakers and amplifier.

Use caution when connecting your Model 2252B to a loudspeaker with built-in power supply such as an electrostatic loudspeaker. The "common" connection terminal of such a speaker may be capacitively coupled to ground through its own power supply. To protect the Model 2252B from distortion and possible overload, make sure the (-) terminals of the Model 2252B are connected to the "common" terminals of such a loudspeaker system.

CAUTION

NEVER DIRECTLY CONNECT THE LOUDSPEAKER TERMINALS OF ONE CHANNEL IN PARALLEL WITH THOSE OF ANY OTHER. ANY RESULTING DAMAGE IS NOT COVERED UNDER WARRANTY.

NOTE

Do not use 4 ohm speakers if system 1 and system 2 speakers are to be used simultaneously. Use 8 or 16 ohm speakers only.

● CONNECTION TO AC OUTLET

With the front panel **POWER** pushswitch "OUT" plug the line cord into an electrical outlet supplying the proper voltage.

CAUTION

DO NOT PLUG YOUR MODEL 2252B INTO A DC OUTLET, AS SERIOUS DAMAGE WILL OCCUR.

● CONVENIENCE OUTLETS

One **UNSWITCHED** and one **SWITCHED AC OUTLET** are provided on the rear panel for powering associated components of your system (tape recorder, record player, etc.).

● AC PROTECTOR FUSE

This feature automatically disconnects AC power in the event of a power source or circuit overload. If the **POWER** pushswitch is activated and the front panel fails to illuminate and no sound is heard through the speakers, turn off the power and unscrew the fuse holder on the rear panel and visually inspect the fuse to see if the internal conducting filament has opened. If so, replace the fuse with one having the same specifications. See "Fuse Replacement", page 15.

● DOLBY PLUG-IN FM DECODER INSTALLATION

The pocket on the rear panel will accommodate Marantz Model DLB-1 Plug-in FM Dolby Decoder. For use, follow the instructions supplied with the optional decoder. For more information, see "Dolby FM Reception", page 7.

● SIGNAL CONNECTIONS CHECKLIST

Before proceeding with operation, double check to make sure the following preparations have been made.

1. **SPEAKERS** connected to **SPEAKER SYSTEM** terminals. Speaker wires are not shorted together.
2. **ANTENNA** connected properly.
3. **AM FERRITE-ROD ANTENNA** extended.
4. **AC LINE CORD** plugged in.
5. **PHONO, TAPE, and AUX** plugs are pushed full into jacks.



Figure 5 Front Panel Controls and Jack

SIMPLIFIED OPERATING PROCEDURES

When operating the Model 2252B Stereo Receiver for the first time, follow these simple directions. Later, full advantage can be taken of its versatility with the remaining controls and pushswitches.

- Step 1. Connect the FM antenna to the appropriate terminals on the rear panel.
- Step 2. Connect the speakers to the **SYSTEM 1** speaker terminals.
- Step 3. Place all pushswitches in the "out" position.
- Step 4. Turn the **VOLUME** control all the way to the left (counterclockwise) and set the balance control in center position.
- Step 5. Rotate **TREBLE**, **MID** and **BASS** controls to the 12 o'clock position (each pair of pointers to dot).
- Step 6. Depress the **SYSTEM 1** speaker pushswitch.
- Step 7. Apply system power by depressing the **POWER** switch.
- Step 8. Select the desired program source by setting the **SELECTOR** switch to the appropriate position. If FM or AM is selected, rotate the **GYRO-TOUCH TUNING** knob until the desired station is tuned. Adjust the volume control to a comfortable listening level.

MAIN CONTROLS AND SWITCHES

● POWER SWITCH

The **POWER** switch, when depressed, supplies AC power to the Model 2252B and to the **SWITCHED** outlet on its rear panel.

● SELECTOR SWITCH

The **SELECTOR** switch selects the program source for listening or recording. For information on the **FM-25 μ S** position, see "Dolby FM Reception", page 7.

● VOLUME CONTROL

The **VOLUME** control adjusts the level of both output channels simultaneously while maintaining stereo balance at all normal settings. It does not affect the recording outputs.

● BALANCE CONTROL

This control alters the level of either output channel in situations where it is necessary to correct unbalanced programs sometimes encountered in older stereo recordings or in stereo broadcasts. As it is moved from its center position, it decreases the level in one output channel while maintaining the level in the other channel.

● BASS, MID AND TREBLE CONTROLS

These controls are used to adjust the tonal balance of program material to suit individual listening preference.

● TUNING METER

The Model 2252B is equipped with two meters, a **SIGNAL STRENGTH** Meter and a **TUNING** Meter.

1. The **SIGNAL STRENGTH** Meter indicates the signal strength of any AM or FM broadcast.
2. The **TUNING** Meter operates on FM only and indicates correct center tuning of the station.

● GYRO-TOUCH TUNING CONTROL

AM

Switch the **SELECTOR** to **AM** and tune to the desired station. Then rotate the **GYRO-TOUCH TUNING** knob slightly back and forth until the maximum reading is obtained on the **SIGNAL STRENGTH** Meter. The **TUNING** Meter is not used for AM.

FM

Switch the **SELECTOR** to **FM** and tune to the desired station. Then slowly rotate the **GYRO-TOUCH TUNING** knob back and forth until maximum reading is obtained on the **SIGNAL STRENGTH** Meter and the **TUNING** Meter points to the center scale position. The multiplex section of the Model 2252B is equipped with electronically triggered circuits which automatically switch to the proper mode of operation for stereo and monophonic FM broadcasts. In addition, the **STEREO** indicator light automatically indicates a stereo broadcast.

● FM-25 μ S SWITCH – DOLBY FM RECEPTION

The Dolby System is an electronic method of reducing the amount of background noise ("tape hiss") inherent in tape recording. The same noise reduction technology is being applied by a growing number of FM radio stations to improve the signal-to-noise ratio of their broadcast signals.

In the case of tape recording, mid- and high-frequency audio signals are increased in level during soft volume passages in the recording and decreased by an identical amount during playback. As a result, the playback signal is identical to the original source signal, but the level of background noise generated by the tape recorder

is greatly reduced.

In the case of Dolby FM broadcasting, the FM broadcast is subjected to the first phase of the Dolby process before being transmitted. When these signals are received by the tuner and passed through a Dolby playback processor, the amount of FM hiss is reduced in the same way as with a tape recorder.

To further improve the noise reduction process, the FM station broadcasting in Dolby applies a special "pre-emphasis" to the frequency response of the music. When receiving these broadcasts, it is necessary to apply the proper "de-emphasis" to return the frequency response to normal.

The **FM-25 μ S** switch on the Model 2252B serves two functions. First, it supplies the proper de-emphasis mentioned above. Second, it internally presets the audio output signal to the standard Dolby level (580 mV) and applies this signal to the **TAPE OUTPUT** jacks and the **EXTERNAL ADAPTOR** socket on the rear panel.

The **EXTERNAL ADAPTOR** socket is designed to accept the optional Marantz Model DLB-1 Dolby FM decoder, which is available at your Marantz dealer. When the adaptor is plugged in and the **FM-25 μ S** switch is depressed, the DLB-1 is automatically placed in circuit to de-process the Dolby-encoded FM broadcast. Additionally, the **DOLBY FM** indicator on the front panel will illuminate.

If your audio system already contains a Dolby-equipped cassette deck (such as the Marantz Models 5420, 5220, 5120 or 5020), or an outboard Dolby unit, then the external adaptor is not necessary. Instead, you may use the Dolby System in one of these other components.

For use with Dolby-equipped cassette decks, refer to the instructions included with them. Depress the **FM-25 μ S** switch on the Model 2252B to supply the proper de-emphasis and output level.

For use with an outboard Dolby unit, connect the playback portion of the Dolby unit to the output of the receiver by way of the **TAPE 1 MONITOR** circuitry. To do this, connect the input of the external Dolby unit to the **TAPE 1 MONITOR OUT** jacks. Then connect the output of the external Dolby unit to the **TAPE 1 MONITOR IN** jacks. When you wish to decode a Dolby-encoded FM broadcast, depress the **FM-25 μ S** pushswitch and also the **TAPE 1 MONITOR** pushswitch. The Dolby unit should be calibrated to the proper level by using the Dolby reference tone transmitted by the FM station at the beginning of the broadcast.

● SPEAKER SYSTEM SWITCHES

These switches select the loudspeaker terminals

to which audio power is fed. Either the SYSTEM 1 or the SYSTEM 2 stereo pair of loudspeakers may be operated individually, or simultaneously if both switches are depressed. When the two **SPEAKER SYSTEM** switches are in the normal "out" position, all loudspeaker terminals are internally disconnected from the power amplifier section. The signal at the headphones jack is not affected by the **SPEAKER SYSTEM** switches. The "out" position allows "private listening" when stereo headphones are used.

NOTE

Volume level should be reduced to minimum when switching speakers.

● PHONES JACK

This jack accepts headphones utilizing a standard three conductor phone plug (see Figure 6). It is internally connected to the power amplifier section through isolation resistors to provide adequate sound level with popular low impedance headphones as well as with high impedance units. Two or more sets of headphones may be used with the aid of "Y" connectors. However, output level will drop as additional headphones are added. The headphone jack output is not affected by the **SPEAKER SYSTEM** switches.

● FM MUTING SWITCH

When tuning to FM broadcasts with the **MUTING** switch in its "in" position, the muting circuit will eliminate interstation noise. To prevent muting very weak stations along with the noise, the muting action may be switched off by releasing the **MUTING** pushswitch.

● LOUDNESS SWITCH

The **LOUDNESS** switch compensates for human hearing characteristics by boosting the bass and treble response at low volume levels to achieve a more pleasing tonal balance.

● HI FILTER SWITCH

This switch can be used to reduce high frequency noise such as that associated with the playing of poorly recorded tapes or worn disc recordings. When the AM tuner is being used, this switch will help to suppress the high pitched "whistle" caused by adjacent AM channel interference. This filter will also, along with high frequency noise, slightly attenuate high frequency program material, and should therefore be used judiciously.

● MONO SWITCH

When a marginal stereo signal is received, random noise and phase modulation may cause the tuner's multiplex circuitry to trigger the **STEREO** mode intermittently. In this case, it is sometimes desirable to cancel the multiplex operation entirely in favor of obtaining a more listenable signal. The **MONO** switch performs this function and converts all output signals to the **MONOPHONIC** mode.

While playing a single channel source such as TV or AM, depress the **MONO** pushswitch to hear the source through both speakers. When playing a monophonic phonograph record, use this pushswitch to suppress rumble, record surface noise, and pinch effect distortion.

● TAPE MONITOR SWITCHES

When the **TAPE MONITOR 1** or **2** switches are depressed individually, the tape recorder connected to the corresponding **TAPE IN** jacks can be monitored. The **TAPE MONITOR** switches interlock electronically, so that only one tape recorder will be heard at a time. If both **TAPE MONITOR** switches are depressed simultaneously, Tape Recorder 1 will be heard. For more information on tape monitoring, see "TAPE MONITORING", page 9.

● TAPE MONITOR SWITCHES, TAPE COPY SWITCHES AND DUBBING JACKS

See the following section on tape recorders.

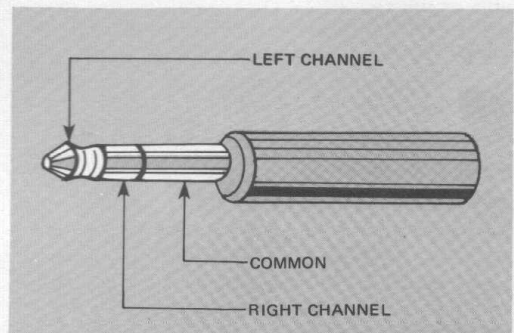

Figure 6 Stereophonic Plug

USING TAPE RECORDERS WITH YOUR MODEL 2252B

The Model 2252B provides three sets of inputs and outputs for tape recorders: **TAPE 1**, **TAPE 2**, and **DUBBING (IN and OUT)**. To simplify this discussion, the tape recorder connected to the **TAPE 1** jacks will be referred to as the "MAIN" recorder; the tape recorder connected to **TAPE 2** will be referred to as the "SECONDARY" recorder; the recorder connected to the **DUBBING** facilities on the front panel will be referred to as the "EXTERNAL" recorder.

● DUBBING JACKS

The **DUBBING IN** jack is the front panel equivalent to the rear panel **TAPE 2 IN** jacks. To connect an "EXTERNAL" tape recorder, it is necessary to use a patch cord having a standard, three-conductor stereo phone plug on one end. Connect the patch cord from the tape recorder line outputs to the Model 2252B **DUBBING IN** jack as shown in Figure 7. When the stereo phone plug is inserted into the **DUBBING IN** jack, the "EXTERNAL" tape recorder pre-empts the "SECONDARY" tape recorder by automatically disconnecting the rear panel **TAPE 2 IN** jacks.

The **DUBBING OUT** jack is the front panel equivalent to the rear panel **TAPE 2 OUT** jacks and is permanently connected in parallel with the **TAPE 2 OUT** jacks. Therefore, any source material available at the rear panel output jacks except that from the **TAPE 2 IN** (when **DUBBING IN** is connected), is simultaneously available at the **DUBBING OUT** jack. The line inputs of the "EXTERNAL" tape recorder are connected to the **DUBBING OUT** jack using the same type of patch cord described in the preceding paragraph.

● TAPE MONITORING

The **TAPE MONITOR** switches operate independently of the **SELECTOR** and **TAPE COPY** switches. Thus any tape recorder can be monitored regardless of which input is chosen. Monitoring of any of the tape recorders may be accomplished as follows:

"MAIN" recorder — Depress the **TAPE MONITOR 1** switch.

"SECONDARY" recorder — Depress the **TAPE MONITOR 2** switch.

"EXTERNAL" recorder — With the "EXTERNAL" recorder connected to the **DUB-**

BING IN jack, depress the **TAPE MONITOR 2** switch.

To cue up the tapes for copying, to set recording levels, or to check the progress of the copying operation, depress the **TAPE MONITOR 1** or **2** switch.

To listen to a different program (such as a tuner or phonograph) during the time a tape is being copied, release the **TAPE MONITOR** switch. Select the source material by means of the **SELECTOR** switch and play it as usual.

● MAKING TAPE RECORDINGS

The **SELECTOR** switch determines the source input for tape recording. When **PHONO 1**, **PHONO 2**, **AM**, **FM**, **FM-25 μ S**, or **AUX** are chosen, the source input can be recorded on to the "MAIN", "SECONDARY", and "EXTERNAL" tape recorders individually or simultaneously. See Figure 7 for typical tape recorder connections.

● HOW TO MAKE TAPE-TO-TAPE COPIES

The tape copying feature on the Model 2252B functions independently of the **SELECTOR** and **TAPE MONITOR** switches. This means that tapes can be copied while listening to an entirely different program source. Operation is as follows:

To make a dub (tape copy) from the "MAIN" recorder on to the "SECONDARY" and/or "EXTERNAL" recorders, depress the **TAPE COPY 1 \times 2** switch. The "MAIN" tape recorder then becomes the tape copy source.

To make a dub from the "SECONDARY" or "EXTERNAL" recorder on to the "MAIN" recorder, depress the **TAPE COPY 2 \times 1** switch. The "SECONDARY" recorder then becomes the tape copy source.

If the "EXTERNAL" tape recorder is connected to the **DUBBING IN** jack, then it pre-empts the "SECONDARY" recorder and becomes the tape copy source instead.

Therefore, dubs to the "MAIN" recorder may only be made from one of these two recorders at a time.

● MAKING MODIFIED TAPE RECORDINGS

The **PRE OUT** jacks on the rear panel of the 2252B may be used to feed input signals to a

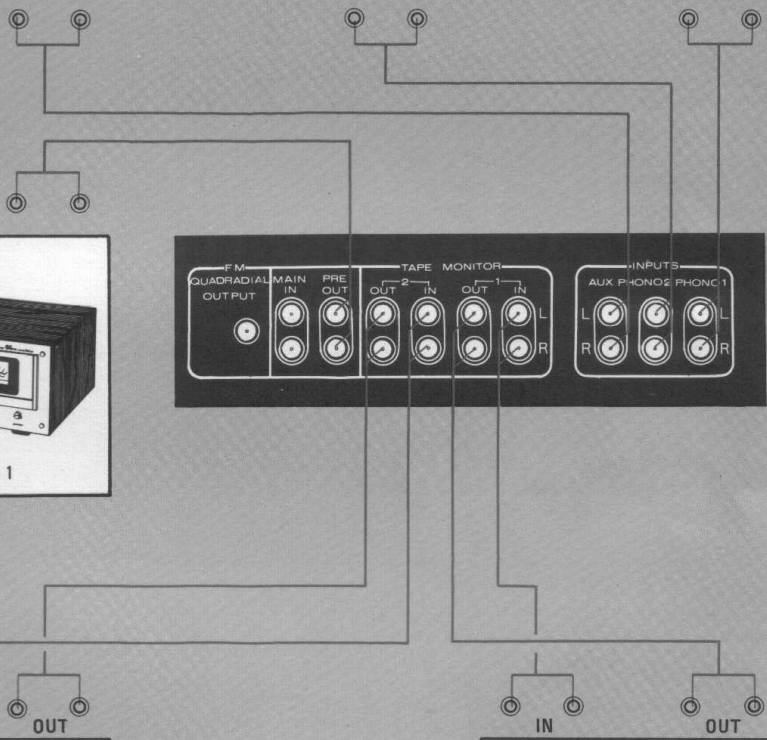
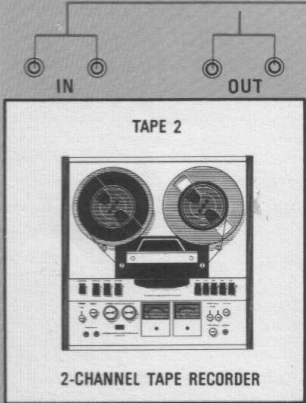
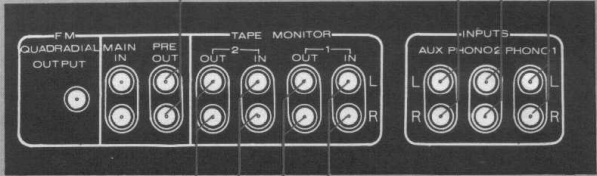
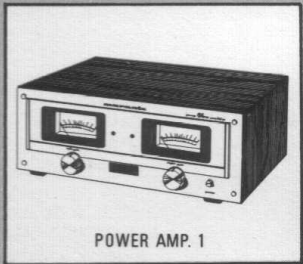

Figure 7 Tape Recorder Connections

USING TAPE RECORDERS WITH YOUR MODEL 2252B

The Model 2252B provides three sets of inputs and outputs for tape recorders: **TAPE 1**, **TAPE 2**, and **DUBBING (IN and OUT)**. To simplify this discussion, the tape recorder connected to the **TAPE 1** jacks will be referred to as the "MAIN" recorder; the tape recorder connected to **TAPE 2** will be referred to as the "SECONDARY" recorder; the recorder connected to the **DUBBING** facilities on the front panel will be referred to as the "EXTERNAL" recorder.

• DUBBING JACKS

The **DUBBING IN** jack is the front panel equivalent to the rear panel **TAPE 2 IN** jacks. To connect an "EXTERNAL" tape recorder, it is necessary to use a patch cord having a standard, three-conductor stereo phone plug on one end. Connect the patch cord from the tape recorder line outputs to the Model 2252B **DUBBING IN** jack as shown in Figure 7. When the stereo phone plug is inserted into the **DUBBING IN** jack, the "EXTERNAL" tape recorder pre-empt's the "SECONDARY" tape recorder by automatically disconnecting the rear panel **TAPE 2 IN** jacks.

The **DUBBING OUT** jack is the front panel equivalent to the rear panel **TAPE 2 OUT** jacks and is permanently connected in parallel with the **TAPE 2 OUT** jacks. Therefore, any source material available at the rear panel output jacks except that from the **TAPE 2 IN** (when **DUBBING IN** is connected), is simultaneously available at the **DUBBING OUT** jack. The line inputs of the "EXTERNAL" tape recorder are connected to the **DUBBING OUT** jack using the same type of patch cord described in the preceding paragraph.

• TAPE MONITORING

The **TAPE MONITOR** switches operate independently of the **SELECTOR** and **TAPE COPY** switches. Thus any tape recorder can be monitored regardless of which input is chosen. Monitoring of any of the tape recorders may be accomplished as follows:

"MAIN" recorder — Depress the **TAPE MONITOR 1** switch.

"SECONDARY" recorder — Depress the **TAPE MONITOR 2** switch.

"EXTERNAL" recorder — With the "EXTERNAL" recorder connected to the **DUB-**

BING IN jack, depress the **TAPE MONITOR 2** switch.

To cue up the tapes for copying, to set recording levels, or to check the progress of the copying operation, depress the **TAPE MONITOR 1** or **2** switch.

To listen to a different program (such as a tuner or phonograph) during the time a tape is being copied, release the **TAPE MONITOR** switch. Select the source material by means of the **SELECTOR** switch and play it as usual.

• MAKING TAPE RECORDINGS

The **SELECTOR** switch determines the source input for tape recording. When **PHONO 1**, **PHONO 2**, **AM**, **FM**, **FM-25 μ S**, or **AUX** are chosen, the source input can be recorded on to the "MAIN", "SECONDARY", and "EXTERNAL" tape recorders individually or simultaneously. See Figure 7 for typical tape recorder connections.

• HOW TO MAKE TAPE-TO-TAPE COPIES

The tape copying feature on the Model 2252B functions independently of the **SELECTOR** and **TAPE MONITOR** switches. This means that tapes can be copied while listening to an entirely different program source. Operation is as follows:

To make a dub (tape copy) from the "MAIN" recorder on to the "SECONDARY" and/or "EXTERNAL" recorders, depress the **TAPE COPY 1 \rightarrow 2** switch. The "MAIN" tape recorder then becomes the tape copy source.

To make a dub from the "SECONDARY" or "EXTERNAL" recorder on to the "MAIN" recorder, depress the **TAPE COPY 2 \rightarrow 1** switch. The "SECONDARY" recorder then becomes the tape copy source.

If the "EXTERNAL" tape recorder is connected to the **DUBBING IN** jack, then it pre-empt's the "SECONDARY" recorder and becomes the tape copy source instead.

Therefore, dubs to the "MAIN" recorder may only be made from one of these two recorders at a time.

• MAKING MODIFIED TAPE RECORDINGS

The **PRE OUT** jacks on the rear panel of the 2252B may be used to feed input signals to a



STEREO TUNER



RECORD PLAYER 2



RECORD PLAYER 1

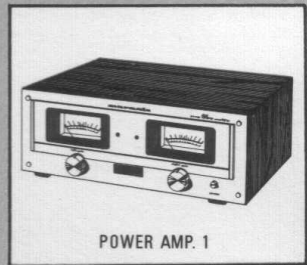

POWER AMP. 1

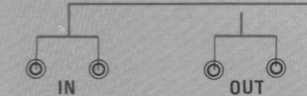
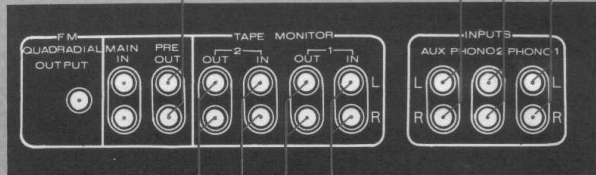

TAPE 2

2-CHANNEL TAPE RECORDER

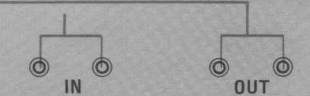

TAPE 1

2-CHANNEL TAPE RECORDER

Figure 7 Tape Recorder Connections

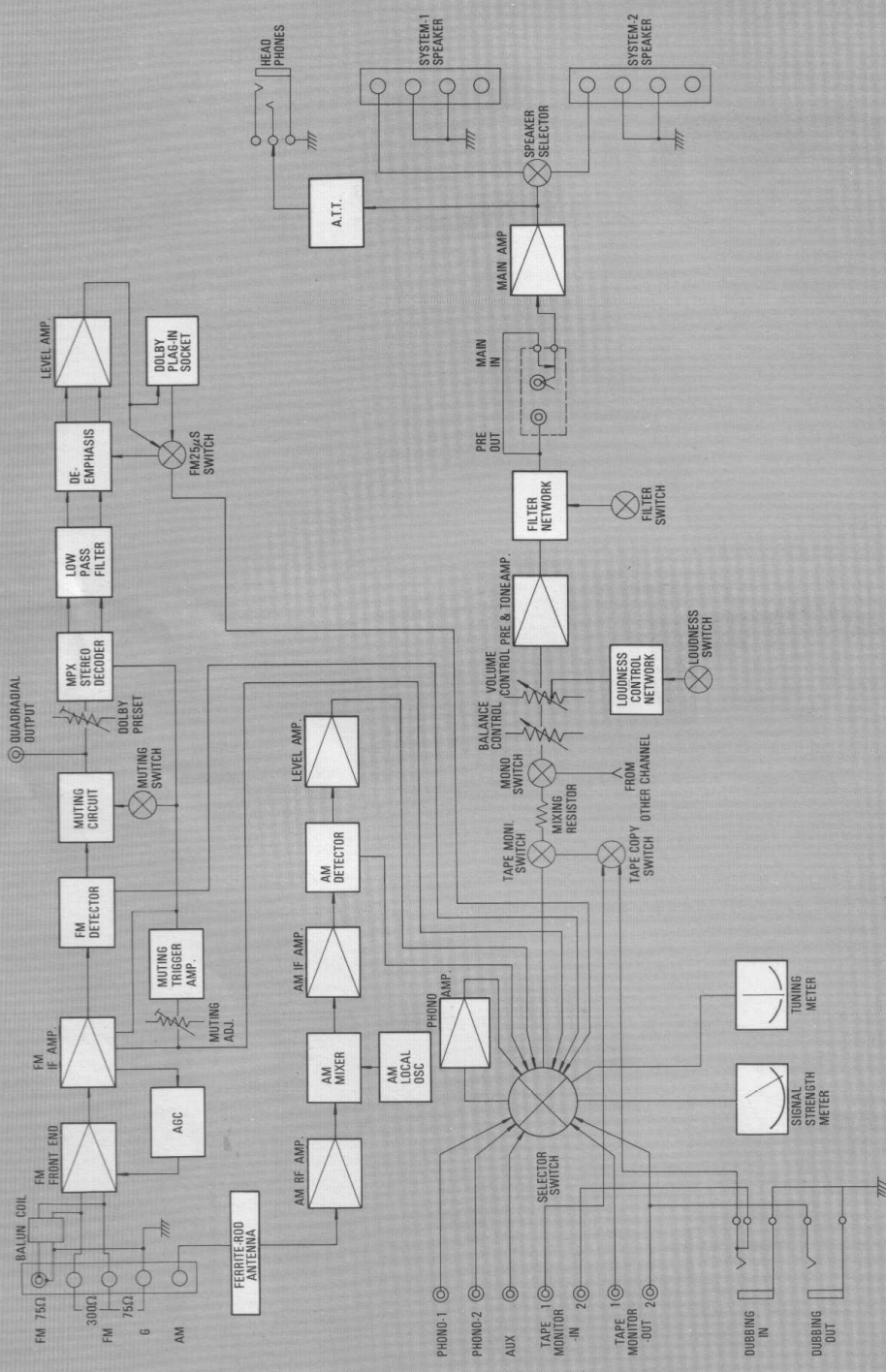

Figure 8 Functional Block Diagram

tape recorder so that filters, balance, and tone controls can be used to modify the signal prior to recording. When using this method, leave the **TAPE MONITOR** switches released.

Modified tape copies can likewise be made. First, select the tape to be used as a source on the **TAPE MONITOR** switches. Next, connect the input of the second tape recorder to the **PRE OUT** jacks. By connecting the output of the second tape recorder directly to the **MAIN IN** jacks, the newly recorded tape can be monitored. However, please note that when this method is employed, the volume level of the speakers is determined only by the output level of the tape recorder. Adjustment of volume is possible only if the recorder has output level controls.

● RECORDING DOLBYIZED FM PROGRAMS

If your audio system contains a reel-to-reel or cassette tape deck with a Dolby Noise Reduction System, you may wish to make a recording of a Dolbyized FM broadcast and then play the program back later through your Dolby System, thus reducing tape hiss and FM hiss at the same time. Since Dolbyized FM programs use a noise reduction technique identical to Dolbyized tape recording, it is possible to record the Dolby-encoded signal directly off the air and on to your tape recorder.

If you are using an outboard Dolby unit, and you wish to make a Dolbyized tape recording of such a broadcast, depress the **FM-25 μ S** pushswitch to properly de-emphasize the signal, but bypass the noise reduction adaptor to record the Dolbyized audio directly onto the tape.

When using a tape recorder containing a built-in Dolby System, the same principal applies: Depress the **FM-25 μ S** pushswitch for proper de-emphasis, and then record "flat" — without Dolby. The result will be a Dolby-encoded tape recording which can then be played back through the Dolby decoding circuitry of the tape deck, just as if you had recorded with Dolby.

NOTE

If the optional Marantz DLB-1 Dolby FM decoder has been fitted to the rear panel receptacle of your Model 2252B, this decoder must be removed in order to obtain Dolby-encoded signals at the **TAPE OUT** jacks.

If your tape deck contains a 25 μ sec FM de-emphasis circuit, a better signal-to-noise ratio can be achieved by using only the de-emphasis circuit in the Model 2252B instead of the facilities in the tape recorder. Do not use both de-emphasis cir-

cuits simultaneously.

The inputs to the tape recorder should be properly calibrated. Refer to the instructions that accompany the tape deck for further details.

TECHNICAL DESCRIPTION

● GENERAL

Figure 8 is a block diagram of the Model 2252B Receiver showing the main functional elements and input and output signal routing. For clarity, only the left audio channel is shown; the right audio channel is identical. The **MONO** switch is common to both channels. All audio controls are ganged to their counterparts in the right channel.

● FM FRONT END

FM antenna signals are applied through the antenna coil to the dual gate MOSFET RF amplifier. The signals from the RF amplifier are fed through the tuned RF tank circuit to the mixer stage where the carrier frequency is converted to the 10.7 MHz intermediate frequency. It is then fed to the input of the IF amplifier.

Careful attention to the thermal and electrical characteristics of the local oscillator has minimized drift, thus eliminating the necessity for AFC.

● FM IF AMPLIFIER

The FM IF amplifier system is composed of one IC expressly developed for FM IF use, plus one transistor and three dual-element ceramic filters. The IC includes a complete IF amplifier, limiter stages, FM discriminator, and a 6-stage double ended type differential amplifier providing excellent AM rejection.

The FM discriminator stage is composed of a double balanced type quadrature detector circuit. The signal from the front end is fed to the IC through the 3 ceramic filters and the one transistor amplifier.

The characteristics of these filters are ideal in that the 200 kHz passband is phase linear, with sharp cutoff slopes. Its exceptional phase linearity assures the elimination of a major source of high frequency distortion and a loss of stereo separation. The sharp cutoff slopes provide outstanding selectivity, permitting reception of closely spaced stations.

● FM STEREO DEMODULATOR

The stereo composite signal obtained from the quadrature detector is fed to the MPX IC. The L and R signal outputs from the MPX IC are applied through the low-pass filter and the de-emphasis circuit to the one (per channel) transistor amplifier. The output (about 1100 mV) obtained from this amplifier is fed to the L and R output terminals at the rear panel through the function switch.

This stereo demodulating IC employs a PLL (Phase Locked Loop) technique, whereby the phase of the 38 kHz switching carrier signal in the decoder is constantly interlocked with the phase of the 19 kHz input pilot signal. Phase shift of the switching carrier (38 kHz) is thereby eliminated and deterioration of separation and distortion does not occur.

The stereo demodulating 38 kHz carrier switching signal is very clean with no even harmonic content. SCA rejection of approximately 80 dB is obtained since resonant beats are not generated between the second harmonic (76 kHz) of the 38 kHz carrier switching signal and the SCA signal (67 ± 7 kHz).

● MUTING CIRCUIT

If there are no signals present, any FM tuner will generate some noise. The muting circuit eliminates this noise. In addition, spurious noise that is generated while tuning is also removed. The muting circuit in the Model 2252B is integrated into the IF stage. The circuit is also designed to minimize popping noises which tend to be generated when muting is switched in and out.

● AM TUNER

The AM tuner section of the Model 2252B is composed of an IC (incorporating an RF amplifier, local oscillator, mixer, IF amplifier, and detector) and a one transistor audio amplifier which amplifies the detected audio signals. A two section variable capacitor is used to tune the antenna and mixer stages. The ceramic filters utilized in the AM IF amplifier are designed for high selectivity and wide bandwidth for interference-free high quality AM reception. Following the AM IF amplifier, the AM detector recovers the audio modulation and presents this signal to the audio amplifying stage and the mode selector switch. The AM tuner and IF amplifier are subjected to the action of an effective automatic gain control circuit which maintains a constant volume level for all stations in the AM band.

● SELECTOR SWITCH

The Model 2252B has the capability to operate from a variety of program sources, such as AM or FM broadcasts, turntable (PHONO) or any other source capable of providing 180 mV output level (AUX). The SELECTOR switch connects the inputs of the TONE control amplifier to the desired source.

● PHONE EQ AMPLIFIER

Phono signals of up to 100 mV can be handled without overloading. The equalization network provides precise equalization to the RIAA standard and sets the voltage gain of the phono pre-amplifier to 40 dB (at 1 kHz).

● MONO FUNCTIONS

When the MONO pushswitch is in the "in" position, the two channels are connected together through mixing resistors. In addition, the left and right channel tape input signals are connected together through the same resistor network. This facility allows all inputs to be converted to the monophonic mode.

● CONTROL CIRCUITS

The control circuits portion of the Model 2252B consists of the BALANCE, VOLUME, BASS, MID, TREBLE, LOUDNESS and HI FILTER, controls. All controls affect the left and right channels simultaneously. However, the BASS, MID and TREBLE controls have clutched sections which allow individual adjustment of tonal balance for each channel. With the controls set for flat response and volume control at maximum, the overall voltage gain from any high-level input to the loudspeaker terminals is approximately 41 dB.

● BALANCE CONTROL

The change of alternation in each channel as the control is moved from center has been designed to decrease the level in one output channel while maintaining the level in the other channel.

● VOLUME CONTROL

The VOLUME control attenuates both channels simultaneously. Since the control is situated at the input of the tone amplifier, there is no possibility of overloading the amplifier stages under maxi-

mum rated output conditions. Thus, distortion is kept to a minimum. After attenuation by the BALANCE and VOLUME controls, the signal is applied to the tone control amplifier.

- **TONE CONTROL AMPLIFIER**

The TONE CONTROL AMPLIFIER's circuitry uses a continuously variable negative feedback type configuration for lowest distortion. The signal from the TONE CONTROL AMPLIFIER feeds the HI filter circuit when the HI FILTER is activated.

- **AMPLIFIER**

The amplifier section of the Model 2252B is a direct coupled, full complementary circuit. It utilizes current limiting and thermal compensation circuits to provide safe, highly stable operating conditions. The silicon output devices used in the power amplifier section provide a large collector dissipation margin.

MAINTENANCE

● CLEANING

The satin gold anodized finish of the knobs and heavy aluminum front panel will last indefinitely with proper care and cleaning. **NEVER** use scouring pads, steel wool, scouring powders, or harsh chemical agents, such as lye solution. These will mar the finish. Clean with a soft, lint-free cloth or cotton swab slightly dampened with a mild solution of detergent and water.

● FUSE REPLACEMENT

The Model 2252B is protected by a 5 amp 250 V fuse. In the event the fuse blows out, replace it **ONLY** with a fuse of the same type and rating. Replacement with a fuse of higher rating will not protect the instrument and will void the warranty.

The unit power should be switched OFF before replacing the fuse. Should the replacement fuse blow out within a short period of time after the unit is turned on, the unit should be taken to an authorized service facility.

● IN CASE OF DIFFICULTY

Should you experience difficulties when operating your system for the first time, and you have followed the procedure outlined in the "Simplified Operating Procedures", use of the following data will help you correct or isolate the problem. If these hints fail to remedy the situation, refer the problem to your nearest authorized service facility.

Receiver does not operate, and dial lamps do not illuminate.

1. Make sure power cord is properly connected.
2. Check AC line fuse; replace if necessary (the unit should be OFF when replacing fuse).

Receiver does not operate, but dial lamp is on.

1. Check settings of controls such as **SELECTOR**, **TAPE MONITOR**, **SPEAKERS** switches **VOLUME**, etc.
2. Turn off **POWER** and check connection of cables from turntables, tape decks, speakers,

and other equipment. Make sure speaker wires are not shorted together.

Receiver operates in one channel only.

1. Check setting of **BALANCE** control.
2. Turn off system power and transpose (left for right) the speaker cables at the **SPEAKER SYSTEMS** terminals. If opposite channel becomes inoperative when turned back on, either the cable or speaker is at fault.

No FM reception.

1. Release **FM MUTING** switch.
2. Connect FM antenna.

FM reception sounds scratchy or raspy.

1. Make sure FM antenna is connected properly.
2. Try re-orienting FM antenna.
3. Determine if you are in a poor reception area. If so, refer to "OUTDOOR FM ANTENNAS" section.

AM reception poor.

1. Swing out AM Ferrite-rod antenna on rear panel.
2. Re-orient the AM ferrite-rod antenna.
3. Determine if other components in your system, appliances, or fluorescent lights are causing interference.
4. Try an outdoor AM antenna. See "OUTDOOR AM ANTENNA" section.

Loud hum in phono.

1. Check to see that phono plugs and jacks are clean and properly connected.
2. Try connecting turntable ground wire (usually colored green) to **CHASSIS GROUND** post on rear panel of receiver.
3. If ground wire is already connected, try disconnecting it.
4. Make sure phono cartridge is wired properly and making good contact with terminals in tone arm.

SERVICE NOTES

● REPAIRS

Only the most competent and qualified service technicians should be allowed to service the Model 2252B. The Marantz Company and its factory-trained warranty station personnel have the knowledge and special equipment needed for repair and calibration of this precision instrument. In the event of difficulty, call the toll free telephone number listed on the back of the Warranty to obtain the name and address of the Marantz Authorized Service Station nearest your home or business. In many cases, the dealer where you purchased your Marantz unit will be equipped to provide service.

● REPACKING FOR SHIPMENT

Should it become necessary to repack your Model 2252B for shipment to the factory, to an authorized service station, or elsewhere, please observe the following precautions:

- a. Do not ship the unit installed in its accessory walnut cabinet, remove the unit from the cabinet before packing.
- b. Pack the unit carefully, using the original material as shown in Figure 9.
PLEASE NOTE that if you have discarded, lost, or damaged the packing material, new packing material may be obtained by writing to the Marantz Technical Service Department. The carton, its fillers, and packing instructions will be returned to you at a nominal charge.
- c. Ship via a reputable carrier (do not use Parcel Post) and obtain a shipping receipt from the carrier.
- d. Insure the unit for its full value.
- e. Be sure to include your return address on the shipping label.

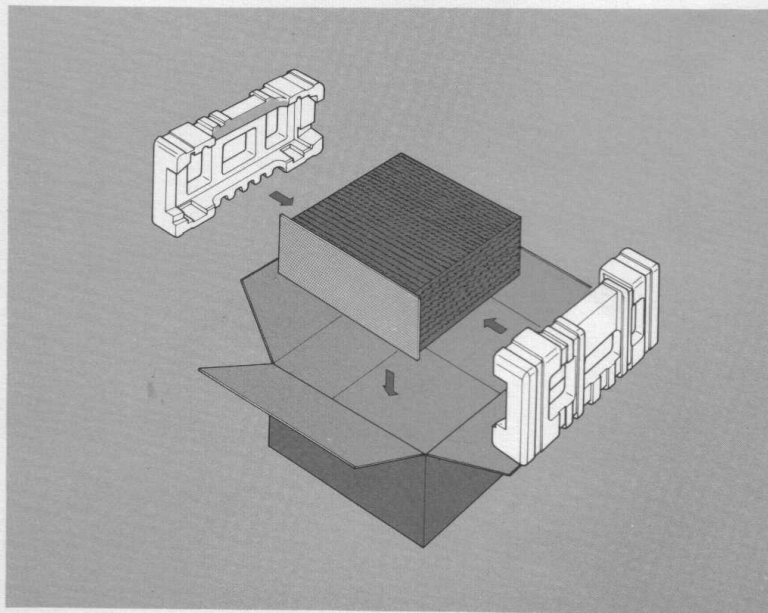

Figure 9 Packing Instructions

The Sound of Marantz
is the compelling warmth of a Stradivarius.
It is a dancing flute, a haughty bassoon
and the plaintive call of a lone French horn.
The Sound of Marantz is the sound of beauty,
and Marantz equipment is designed to bring you
the subtle joy of its delight.
Wonderful adventures in sound await you
when you discover that the Sound of Marantz
is the sound of music at its very best.



marantz.

MODEL 2252B TECHNICAL SPECIFICATIONS

AMPLIFIER SECTION:

RATED POWER OUTPUT, MINIMUM CONTINUOUS AVERAGE POWER PER CHANNEL, BOTH CHANNELS DRIVEN.....	52W
POWER BAND.....	20Hz to 20kHz
TOTAL HARMONIC DISTORTION.....	0.05%
LOAD IMPEDANCE.....	8 OHMS
RATED POWER OUTPUT, MINIMUM CONTINUOUS AVERAGE POWER PER CHANNEL, BOTH CHANNELS DRIVEN.....	65W
POWER BAND.....	20Hz to 20kHz
TOTAL HARMONIC DISTORTION.....	0.1%
LOAD IMPEDANCE.....	4 OHMS

I.M. Distortion

(I.H.F. method, 60 Hz and 7 kHz mixed 4:1 at rated power output)

at 8 ohm load impedance	0.05%
at 4 ohm load impedance	0.1%
Damping Factor (at 20 Hz)	45
Sensitivity (at MAIN IN)	1.5 V
Impedance (at MAIN IN)	33 kohms
Frequency Response for Power Amp Only (at 1 Watt output, 20 Hz to 20 kHz)	±0.2 dB

PREAMPLIFIER SECTION:

Phono

Input Overload at 1 kHz	100 mV
Equivalent Input Noise	1.5 μV
Dynamic Range (Dynamic Range is the ratio of input overload to equivalent input noise)	96 dB
Input Sensitivity	1.8 mV
Input Impedance	47 kohms
Input Capacitance	100 PF
Frequency Response, RIAA 20 Hz to 20 kHz	±0.75 dB
Signal-to-Noise Ratio (at rated output and 7.75 mV input)	76 dB
High Level (Aux and Tape)	
Input Sensitivity	180 mV
Input Impedance	20 kohms
Frequency Response (includes power amp)	10 Hz to 60 kHz ± 1.25 dB
Signal-to-Noise Ratio (ref. to rated output and 775 mV input)	90 dB
Output Levels	
Tape Out (ref. 7.75 mV at Phono inputs)	775 mV
Pre-Out (ref. 180 mV at Aux inputs)	1.5 V
(ref. 500 mV at Aux inputs, main amp disconnected)	4.2 V
Output Impedance	
Tape Out	600 ohms
Pre-Out	900 ohms

FM TUNER SECTION:

Sensitivity

IHF Usable	10.8 dBf (1.9 μV)
IHF 50 dB Quieting (Mono)	16.1 dBf (3.2 μV)
(Stereo)	37.3 dBf (40 μV)

Quieting Slope (Mono)	
RF Input for 30 dB Quieting	9.3 dBf (1.6 μ V)
Quieting at:	
20 dBf (5.5 μ V)	55 dB
25 dBf (10 μ V)	60 dB
40 dBf (55 μ V)	70 dB
65 dBf (1000 μ V)	75 dB
Quieting Slope (Stereo)	
Quieting at:	
30 dBf (17 μ V)	42 dB
40 dBf (55 μ V)	53 dB
50 dBf (173 μ V)	58 dB
65 dBf (1000 μ V)	65 dB
Distortion (Mono) at 65 dBf (1000 μ V)	
100 Hz	0.25%
1000 Hz	0.15%
6000 Hz	0.35%
Distortion (Stereo) at 65 dBf (1000 μ V)	
100 Hz	0.35%
1000 Hz	0.3 %
6000 Hz	0.55%
Distortion (Mono and Stereo)	
at 50 dB Quieting, 1000 Hz	0.6%
Hum and Noise	
at 65 dBf (1000 μ V)	
Mono	73 dB
Frequency Response	
30 Hz to 15 kHz	
Mono	+0.2 dB, -1.5 dB
Stereo	\pm 1.5 dB
Capture Ratio at 65 dBf (1000 μ V)	1.0 dB
Alternate Channel Selectivity	70 dB
Spurious Response Rejection	90 dB
Image Response Rejection	70 dB
I.F. Rejection (Balanced)	95 dB
A.M. Suppression	50 dB
Stereo Separation	
100 Hz	40 dB
1000 Hz	45 dB
10 kHz	40 dB
Subcarrier Rejection	60 dB
AM TUNER SECTION:	
IHF Usable Sensitivity	15 μ V
Distortion (THD), 30% Modulation	0.5%
Signal-to-Noise Ratio	50 dB
Alternate Channel Selectivity	46 dB
Image Rejection	45 dB
Spurious Response Rejection	60 dB
I.F. Rejection	40 dB
GENERAL:	
Power Requirements	120 VAC, 60 Hz
Power Consumption at rated output, both channels operating	220 W
Idling Power (Volume Control at zero)	35 W
Dimensions:	
Panel Width	440 mm (17-5/16 inches)
Panel Height	137 mm (5-3/8 inches)
Depth	362 mm (14-1/2 inches)
Weight:	
Unit alone	14.2 kg (31.2 lbs)
Packed for Shipment	16.7 kg (36.7 lbs)