

TABLE OF CONTENTS

GENERAL DESCRIPTION	1
TECHNICAL DESCRIPTION	1
Mechanical Specifications	2
Electrical Specifications	2
FRONT PANEL FACILITIES	2
BACK PANEL FACILITIES	5
INSTALLATION	6
CONNECTING	8
A-C Connections	8
Input Connections	9
Output Connections	10
Loudspeaker Phasing Connections	11
Ground Connection	11
OPERATING INSTRUCTIONS	11
Balancing a Stereo System	11
Adjusting Phase	12
Listening to a Stereo Record	12
Adjusting the Balance Control After the System has been Balanced	12
Adjusting for Special Effects	12
Using the C11 with a Stereo Tuner	13
Using the C11 with a Stereo Tape Machine	13
Using the C11 with Tape Deck	13
Using the C11 with Microphones for Stereo	13
Listening to Monophonic Records	13
GUARANTEE	16



OWNER'S MANUAL

ISSUE NO. 1

Reading Time 30 Minutes

Price \$1.25

C11

C11 STEREOPHONIC PREAMPLIFIER

GENERAL DESCRIPTION

The McIntosh C11 Stereophonic Preamplifier is a control center for any stereophonic sound system. To increase the enjoyment of stereo, this control center does four jobs with precise control.

First, the control center amplifies weak electrical impulses. As the record rotates on the turntable, undulations in the grooves move the pick-up stylus approximately one-thousandth of an inch, in any direction, from the rest position. From this slight mechanical movement, the pick-up stylus generates a weak electrical impulse on the order of a few thousandths of a volt. To amplify and preserve the information in such an electrical impulse, the finest amplifier performance is required.

Second, every sound system is used in a different acoustical environment. The tone balance of the music is affected by variations

in environment. Also, people listening to the music have varying ideas of correct tone balance. To compensate for these conditions, a high-quality control center is needed.

Third, there is a great variety of stereophonic and monophonic records manufactured today, both domestic and foreign. The control center must accurately compensate for the equalization introduced in the recording process.

Fourth, with programs originating from several sources such as tuners, records, tape machines, microphones, etc., a control center is needed to select and switch these sources separately or in combination.

All of these jobs are performed with excellence by the C11 and yet this instrument is simple to operate, easy to mount, and is the finest in appearance.

TECHNICAL DESCRIPTION

The C11 Stereophonic Preamplifier combines excellence in performance with ease of operation. The controls used the most have large diameter knobs. A new type of rocker switch indicates those controls with simple off-on functions. The C11 has an illuminated front panel with light intensity control to provide convenient reading under low-level lighting conditions.

The C11 circuit consists of three amplifying sections in duplicate for the left and right stereo channels and a power supply. The first section is the input preamplifier used to amplify and equalize the input signals coming from phonograph pickups, microphones, or tape heads. Skillful layout, grounding, and shielding for low hum pickups, metal film and wire wound resistors, terminal boards with high specific resistivity, low noise tubes and extreme care in manufacturing combine to achieve a new low in noise and hum.

The second amplifying section follows the volume control, and thus it is impossible to overload the circuit or any following circuits. The same techniques as were used in the preamplifier stage assure low hum and noise. The bass and treble tone controls are feedback type circuits and operate in connection

with this section. Exceedingly low distortion and correct frequency response are assured using this arrangement.

The third section is the cathode follower output. The sharp cut-off (18db per octave) rumble and high frequency filters are associated with this section. Output level set controls are located at the input of the cathode follower to allow simple balance of the entire amplifying and speaker system. These controls are conveniently accessible at each side of the front panel under the end caps.

The power supply deserves special mention. The power transformer is constructed with "core" type grain oriented laminations and magnetic shielding for low hum field. Long life rectifiers, full wave rectification, filter condenser sectionalizing and careful grounding add to the hum free and long life characteristics of the C11.

Special attention has been given to the mechanical design also. The C11 may conveniently be installed in furniture cabinets, custom built installations, or professional relay racks. The tubes and the electrical connections are conveniently located on the back panel of the C11 for ready access.

MECHANICAL SPECIFICATIONS

Dimensions

Chassis: 14½ inches wide; 4¾ inches high;
12 inches deep including connectors.

Front Panel: 15¾ inches wide; 5¹/₈ inches high

Front Panel Mounting Space Required: 16³/₈ inches wide; 5¼ inches high

Weight

Chassis: 15 pounds

Shipping Weight: 25 pounds

Finish

Anodized gold and black (front panel)

ELECTRICAL SPECIFICATIONS

Power Requirements

117 volts, ac, 50/60 cycles, 30 watts

Input Sensitivity and Input Impedance

Auxiliary: 0.25 volt; 250,000 ohms

Tape: 0.25 volt; 250,000 ohms

Tuner 1: 0.25 volt; 250,000 ohms

Tuner 2: 0.25 volt; 250,000 ohms

Phono 1: 2 millivolts; 47,000 ohms

Phono 2: Same as phono 1

Tape Head: 2 millivolts; 1 megohm

Tape Compare (Monitor): 0.25 volt; 250,000 ohms

Microphone: 2.5 millivolts; 1 megohm

Frequency Response

± 0.5 db; 20 to 20,000 cycles

Distortion

Less than 0.2% at rated output, 20 to 20,000 cycles

Hum and Noise

High-level inputs: 85 db below rated output

Low-level inputs: less than 2 microvolts at input terminals

Main Output

2.5 volts with rated input

2 output jacks in parallel for each channel

Tape Output

0.25 volt with rated input

1 output jack for each channel

Left Plus Right Output

1 volt from generator impedance of 25,000 ohms

Voltage Amplification

Low-level inputs to Main Output: 1,000 to 1 (60db) at 1000 cycles

Low-level inputs to Tape Output: 100 to 1 (40 db) at 1000 cycles

High-level inputs to Main Output: 10 to 1 (20 db)

High-level inputs to Tape Output: 1 to 1 (0 db)

Tape Compare (Monitor) input to Main Output: 10 to 1 (20 db)

A-C Auxiliary Outlets

1 unswitched for tape machine or turntable, colored Red

4 switched, colored Black

FRONT PANEL FACILITIES

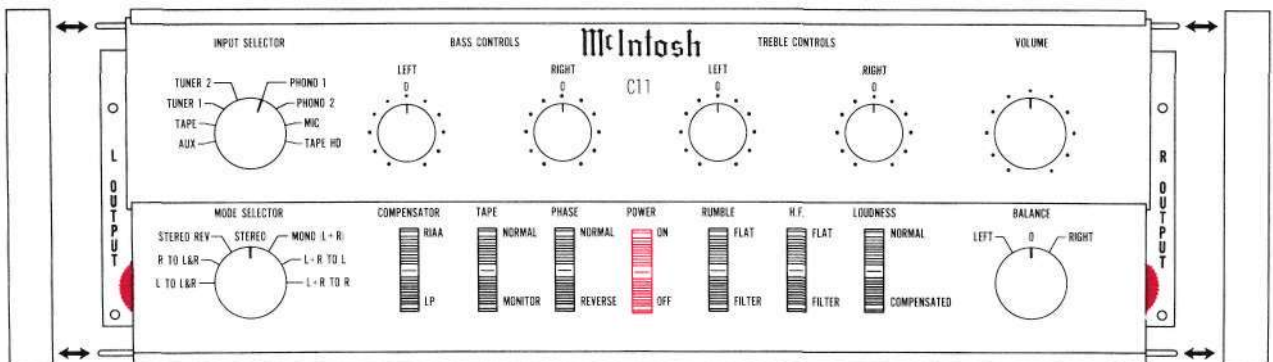
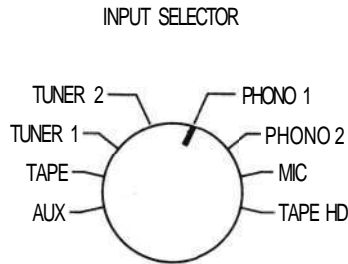

Figure 1. C11 Front Panel

INPUT SELECTOR



Select any one of eight program sources with this switch:

1. AUX: any auxiliary service requiring flat amplification, such as a television set, is connected to the C11 through this position.
2. TAPE: any self-contained tape machine (tape machine having its own playback preamplifier) is connected to the C11 through this position.
3. TUNER 1: AM and FM outputs from a stereo tuner or MPX FM program are connected to the C11 through this position.
4. TUNER 2: same as TUNER 1.
5. PHONO 1: connects the C11 for stereo and monophonic operation for records.
6. PHONO 2: same as PHONO 1.
7. MIC: stereo microphones are connected to the C11 through this position.
8. TAPE HD: a tape deck that does not contain its own playback preamplifier is connected to the C11 through this position.

MODE SELECTOR

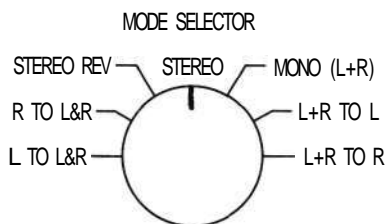

Use the MODE SELECTOR to:

Listen to normal stereo (4 following and page 16).

Reverse the left and right arrangement of musical instruments (3 following and page 12).

Balance the amplifiers and loudspeakers in a stereo system (6 and 7 following and page 11).

Listen to monophonic sound (1 and 2 following and page 13).

Listen thru both loudspeakers to either track of a stereo program source.

Turn the MODE SELECTOR to:

1. L TO L & R: connects the "left" input to both loudspeakers.
2. R TO L & R: connects the "right" input to both loudspeakers.
3. STEREO REV: connects the "left" input to the "right" loudspeaker and the "right" input to the "left" loudspeaker.
4. STEREO: connects the "left" input to the "left" loudspeaker and the "right" input to the "right" loudspeaker.
5. MONO (L+R): adds the "left" input and the "right" input and then connects the L+R program to both amplifiers and loudspeakers.
6. L+R TO L: connects the "left plus right" programs to the "left" loudspeaker only.
7. L+R TO R: connects the "left plus right" programs to the "right" loudspeaker only.

BASS CONTROLS

BASS CONTROLS

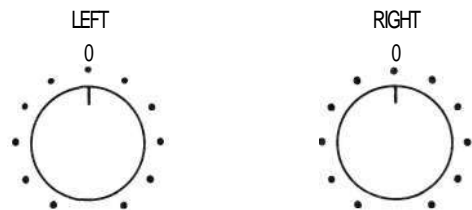

The LEFT and RIGHT BASS CONTROLS regulate bass loudness to the left and right speakers, respectively. Clockwise rotation increases bass loudness; counterclockwise rotation decreases bass loudness.

TREBLE CONTROLS

TREBLE CONTROLS

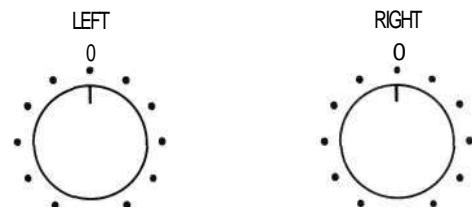

The LEFT and RIGHT TREBLE CONTROLS regulate treble loudness to the left and right speakers, respectively. Clockwise rotation increases treble loudness; counterclockwise rotation decreases treble loudness.

BALANCE

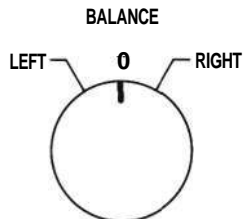

The C11 is balanced for unequal program sources by this control.

LEFT . . . turning the control to the left accents the left channel by reducing the right channel output.

RIGHT . . . turning the control to the right accents the right channel by reducing the left channel output.

COMPENSATOR

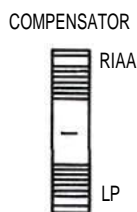

This control corrects for program equalization introduced by the recording process.

TAPE

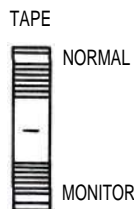

This control makes it possible to instantaneously compare the recorded material with the source signal. Tape jacks on the back panel accept a signal from a tape recorder with a monitor head and preamplifier.

NORMAL . . . the program source is fed through the power amplifiers and the loudspeakers.

MONITOR . . . the signal source becomes the monitored program from the recorded tape and is fed through the power amplifiers and loudspeakers.

PHASE

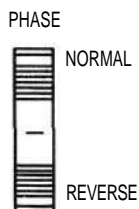

This two-positioned switch reverses the phase in the left channel to correct for loudspeaker or program phasing.

POWER



The C11 and the four black receptacles on the back panel are turned on by this switch.

RUMBLE

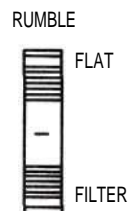

Low-frequency rumble noise below 50cps created by a turntable or record changer and acoustically coupled feedback are reduced when the RUMBLE filter button is pushed to the FILTER position.

H.F.

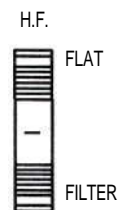

This switch minimizes surface noise when reproducing old, badly worn recordings. Its positions are:

FLAT . . . filter disconnected.

FILTER . . . rolls off response sharply at 5KC.

LOUDNESS

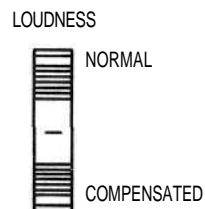

This switch converts the VOLUME control to a loudness compensated control when in the COMPENSATED position.

VOLUME

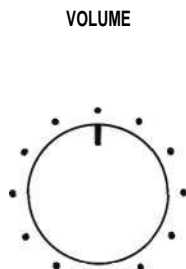

This continuously variable control regulates the volume for both channels.

OUTPUT LEVEL CONTROLS

Under the panel end caps are the thumb wheel OUTPUT LEVEL CONTROLS. The L OUTPUT is on the left-hand side. The R OUTPUT is on the right-hand side.

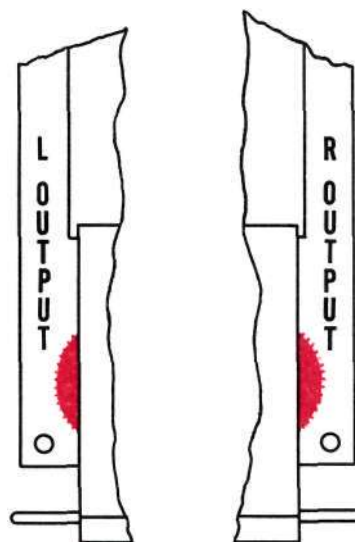

BACK PANEL FACILITIES

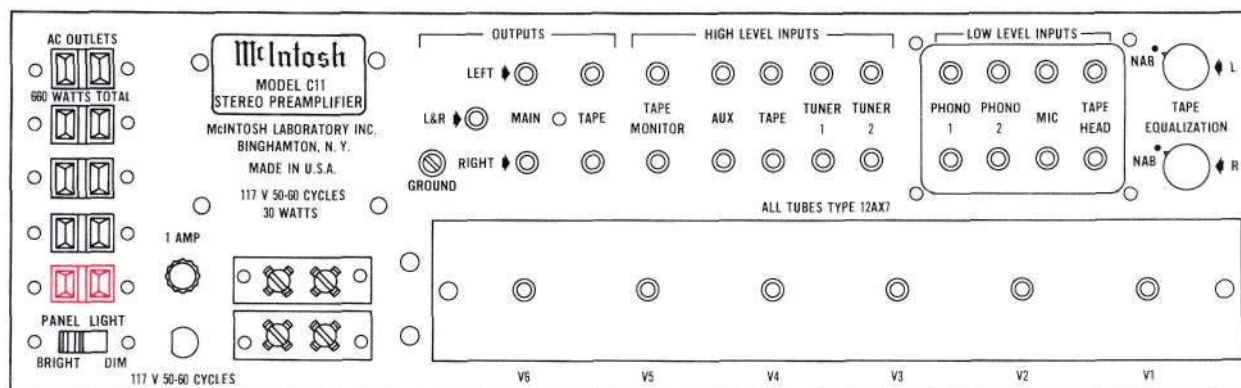

Figure 2. C11 Back Panel

AC OUTLETS

There are five AC outlets on the left-hand side of the rear panel. (See Figure 2.) These outlets have a maximum rating of 660 watt total. The four black outlets are controlled by the POWER ON-OFF switch on the front panel. The red outlet is used for powering a turntable or record changer. This outlet is not switched so that the turntable power will not be turned off while the turntable idler wheel is engaged. With this arrangement it is necessary to turn off the turntable with its own control switch so that the turntable drive system will not be damaged.

PANEL LIGHT

The PANEL LIGHT switch, located in the lower left-hand corner of the back panel, provides a choice of bright or dim front panel lighting.

OUTPUT CONNECTIONS

The MAIN output connects to power amplifiers (Figure 2); the TAPE output connects to a tape recorder.

The MAIN and TAPE output jacks are fed from cathode followers. The input impedance of devices connected to these outputs should be 50,000 ohms or greater. The capacitive reactance of connecting audio cables should not be less than 8,000 ohms at 20,000 cycles. Longer cables than are normally supplied can be connected between the C11 and the amplifiers or loudspeakers. The length of the cable is limited by the capacity of the cable per foot. The total capacity must not exceed 1000 mmf. For instance; cables with a capacity of 25 mmf per foot may be 40 feet long; 13.5 mmf per foot cable may be 75 feet long.

HIGH LEVEL INPUTS

These receptacles accept high-level program source connections as follows:

TAPE MONITOR (COMPARE) . . . accepts a signal from a tape recorder with a monitor head and preamplifier.

AUX . . . accepts any auxiliary service requiring flat frequency response, such as a T.V. set, tuner, tape recorder with its own playback preamplifier, etc.

TAPE . . . accepts connection from a tape machine with its own playback preamplifier.

TUNER 1 & TUNER 2 . . . accept AM and FM outputs from a stereo tuner or a pair of stereo tuners.

LOW LEVEL INPUTS

These receptacles accept low-level program source connections as follows:

PHONO 1 & 2 . . . accepts connection for normal stereo and normal monophonic operation.

MIC . . . accepts connection from stereo microphones.

TAPE HEAD . . . accepts connection from a

tape deck that does not contain its own playback preamplifier.

TAPE EQUALIZATION

On the back panel there are two tape equalizing controls. These controls should be set to NAB for normal 7.5 inch tape speed machines. Turning the TAPE EQUALIZATION controls clockwise increases the treble response, turning it counterclockwise decreases the treble response. Use the controls to compensate for 3% tape speed for individual tape head characteristics.

LOUDSPEAKER PHASING CONNECTIONS

Two pairs of screw terminals are located on the lower left section of the C11 back panel. The speaker leads from the "left" power amplifier should be connected to the screw terminals marked FROM AMPLIFIER. The pair of terminals marked TO SPEAKER should be connected to the "left" loudspeaker.

These connections allow the front panel PHASE switch to reverse the phase on the left loudspeaker. This arrangement is convenient when setting up a stereo system.

The C11 can be installed in conventional furniture cabinets, custom built installations or professional relay racks. If the unit is to be placed on a shelf or table-top, it is recommended that it be housed in a McIntosh L66 cabinet. Install the C11 from the front of the cabinet, not from the rear.

To support the weight of the C11, the wood panel used to mount it, should be at least $\frac{1}{4}$ inch thick. If the front panel of a cabinet is made of wood, a shelf may be needed to support the rear of the chassis to prevent

warping. When the C11 is mounted on a metal rack panel, a shelf is not needed.

The C11 installation should allow 12 inches behind the front panel so that there is at least $1\frac{1}{2}$ inches for connectors. The desirable width and height are $16\frac{1}{2}$ inches and $5\frac{1}{2}$ inches, respectively, so that sufficient space is allowed for the circulation of air. These are inside dimensions. The front panel mounting space width and height are $16\frac{3}{8}$ inches and $5\frac{3}{8}$ inches, respectively.

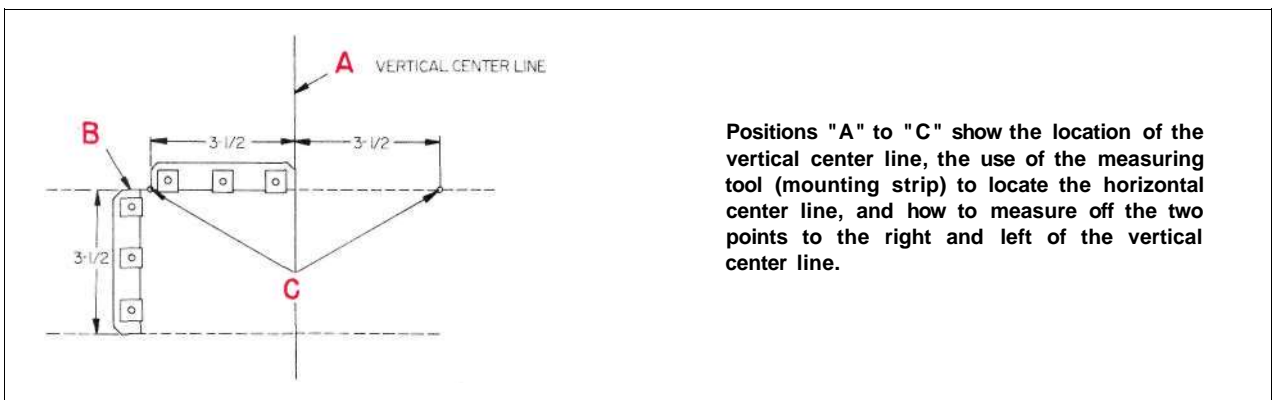

Figure 3. Cutout Measurements

MAKING THE FRONT PANEL CUTOUT

The panel is cut out using the "FRONT PANEL CUTOUT TEMPLATE." To position the template on the front of the panel, make two locating holes from the back (inside) of the panel using one of the mounting strips ($\frac{1}{2}$ inch by $3\frac{1}{2}$ inches) as a measuring tool. Proceed as follows:

Scribe a vertical center line through the exact center of the proposed cutout area from the top of the panel to the top surface of the shelf as illustrated in "A," Figure 3. Using one of the mounting strips as a measuring tool, draw a horizontal line $3\frac{1}{2}$ inches above the shelf. (See "B," Figure 3.) Place a mounting strip along the horizontal line to the left of the vertical center line and mark a point $3\frac{1}{2}$ inches left from the vertical center line. Repeat this procedure and mark a point $3\frac{1}{2}$ inches to the right of the vertical center line. These points should now be $3\frac{1}{2}$ inches up from the top of the shelf and 7 inches apart, one $3\frac{1}{2}$ inches to the left and one $3\frac{1}{2}$ inches to the right of the vertical center line. (See "C," Figure 3.) Drill a $\frac{3}{16}$ inch hole at each point. Hold the drill perpendicular to the front panel so that the hole will be located accurately on the front of the panel.

Position the template on the front of the panel using the two locating holes to line it up correctly. Scribe the rectangular opening on the front panel and mark the position of the six mounting holes. Drill the six $\frac{3}{16}$ inch mounting holes before cutting the panel opening. Then cut out the opening. It is important that the cutout be just within the lines.

SHELF MOUNTING

If the installation requires a shelf, proceed as follows: Locate the center of the shelf and scribe a line from front to back. The "SHELF CUTOUT PLATE" is marked for panel thicknesses from $\frac{1}{4}$ inch to 1 inch. Fold the template on the line that corresponds to the thickness of the panel. Place it on the shelf so that it butts against the inside of the panel. Match the center line mark on the template to the scribed center line on the shelf. Mark the position of the four drill holes. Drill the four $\frac{1}{4}$ inch holes.

INSTALLING THE C11

Remove the four screws holding the C11 to the shipping pallet. (Save these screws, you will need them if your cabinet has a $\frac{1}{4}$

inch or $\frac{3}{8}$ inch shelf.) Remove the four plastic feet from the bottom of the C11.

In the mounting hardware package are four 6-32 flathead screws and eight 6-32 roundhead screws. Two of the flathead screws of the proper length are used to attach the mounting strips to the cabinet. Four of the roundhead screws of the proper length are used to attach the C11 to the cabinet and mounting strips. The 6-32 x $\frac{1}{2}$ inch screws are to be used with panels $\frac{1}{2}$ inch to 1 inch in thickness.

Select the proper length 6-32 flathead screws and use them to install the two mounting strips behind the front panel. Be sure that the edge of the strip with the clips is toward the panel opening. Line up the mounting strips on each side of the front panel cutout so the three holes in the strip are in line with the three holes in the panel. (See Figure 4.) Install the proper length flathead screws in the center hole of each strip. Drive them in so the flatheads are flush with the panel; if necessary, countersink the two center holes.

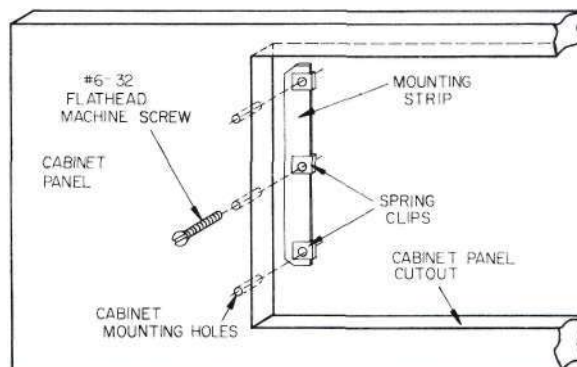

Figure 4. Securing the Mounting Strip to the Front Panel

Carefully insert the C11 through the front of the panel opening so that it rests on the shelf. Insert the proper length 6-32 roundhead screws into the four holes in the mounting flanges on each end of the tuner front panel. Drive them in, but do not tighten.

If the cabinet is fixed and will not be moved about, it is not necessary to secure the C11 chassis to the shelf. If the cabinet is to be moved about, it is recommended that the C11 chassis be secured to the shelf. The four 10-32 x $\frac{1}{2}$ inch screws used in shipping are supplied for use if the shelf is under $\frac{3}{8}$ inch. Use the 10-32 x $\frac{3}{4}$ inch screws if this shelf is $\frac{1}{2}$ inch or $\frac{5}{8}$ inch thick and the 10-32 x 1 inch screws if the shelf is $\frac{3}{4}$ inch or $\frac{7}{8}$

inch thick. Secure the chassis with the proper length 10-32 machine screws, inserting them from beneath the shelf. Do not tighten the 10-32 screws until you have tightened the front panel screws.

**IMPORTANT:
USE OF THE WRONG LENGTH 10-32
SCREWS MAY CAUSE ELECTRICAL
SHORTING IN THE CIRCUIT.**

Attach the two metal panel end caps (packed with mounting hardware) on each end of the panel by sliding onto the pins. (See Figure 5.) The end caps are held by spring tension and can easily be removed if the chassis is to be taken out of the cabinet.

MOUNTING IN THE L66 CABINET

The McIntosh L66 cabinet is supplied with complete instructions and all necessary hardware for installing the C11. The dimen-

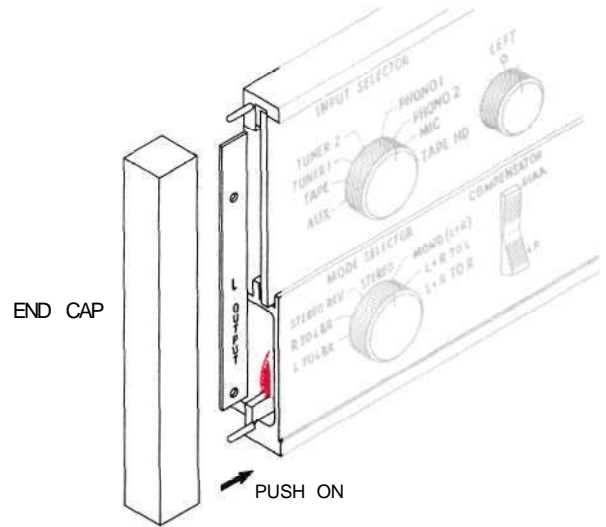

Figure 5. Fitting of Panel End Caps to Panel

sions of the L66 are $16\frac{9}{16}$ inches wide by $6\frac{11}{16}$ inches high, including mounting feet, by $13\frac{3}{4}$ inches deep, including the front panel and control knobs.

CONNECTING

A-C CONNECTIONS

There are five a-c receptacles on the rear panel. (See Figure 6.) These receptacles have a maximum rating of 660-watt total. The four black receptacles are controlled by the POWER ON-OFF switch on the front panel. The red receptacle is not switched. The red receptacle is used for powering a turntable

or record changer. The receptacle is not switched so that the turntable power will not be turned off while the turntable idler wheel is engaged. The turntable is protected by this arrangement because it is necessary to turn off the turntable with its own control switch so that no damage will result to the drive system.

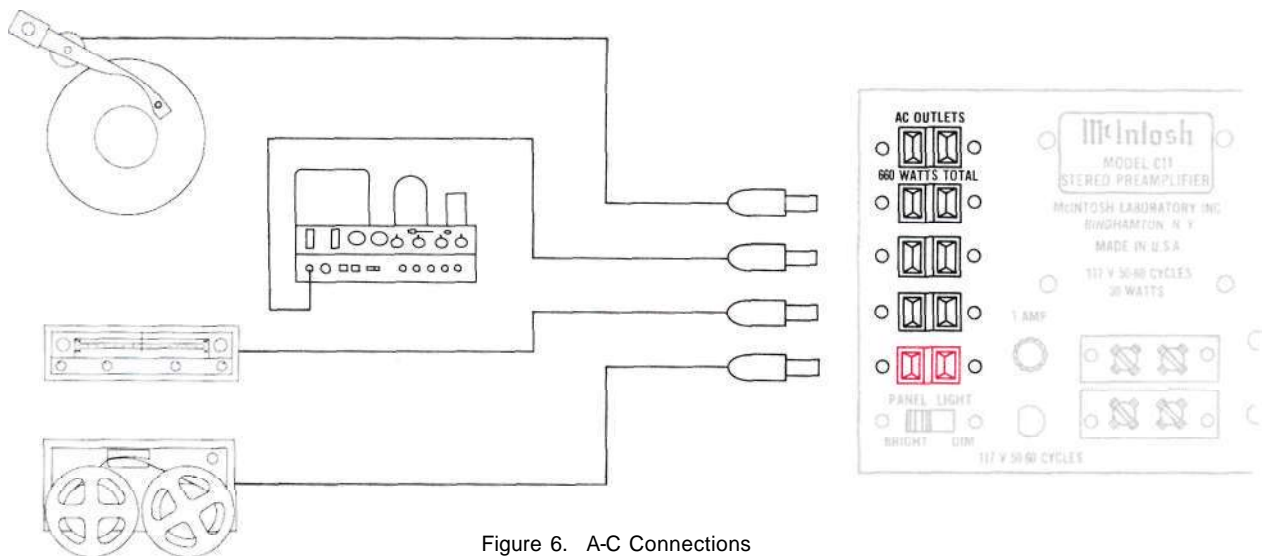

Figure 6. A-C Connections

The C11 provides eight separate program inputs controlled by the INPUT SELECTOR switch and one input for tape comparison or

monitor.

The input program connection should be made in accordance with Tables 1 and 2.

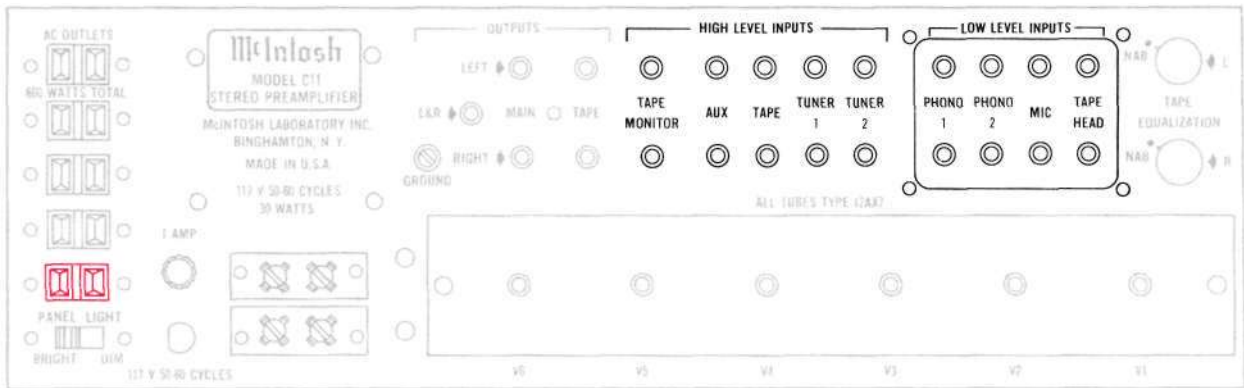

Figure 7. C11 Input Connections (Back Panel)

CONNECTION	FUNCTION	INPUT SENSITIVITY	INPUT IMPEDANCE
TAPE MONITOR (COMPARE)	The tape monitor input accepts a signal from a tape recorder with a monitor head and preamplifier.	0.25 V	250K
AUX	The auxiliary input accepts any auxiliary service requiring flat frequency response, such as a T.V. set, tuner, tape recorder with its own playback preamplifier, etc.	0.25 V	250K
TAPE	The tape input operates with tape machines containing their own playback preamplifier.	0.25 V	250K
TUNER 1 & TUNER 2	The tuner inputs accept AM and FM outputs from a stereo tuner or a pair of stereo tuners or the multiplex output of an adapter or multiplex tuner.	0.25 V	250K

CONNECTION	FUNCTION	INPUT SENSITIVITY	INPUT IMPEDANCE
PHONO 1 & 2 MAGNETIC	These jacks are to be used with magnetic cartridges.	2 MV	47 K
TAPE HEAD 1 & 2 2-10 MV	These jacks are to be used with a tape deck that does not contain its own playback preamplifier.	2 MV	1 megohm

If a phono cartridge requires less than 47,000 ohms load impedance, a resistor can be added across the terminals of the car-

tridge to achieve the correct termination. The following chart may be used as a guide:

Desired Impedance	Resistor Across Input
47,000 ohms (47K)	No Resistor
37,000 ohms (37K)	180,000 ohms (180K)
27,000 ohms (27K)	62,000 ohms (62K)
15,000 ohms (15K)	22,000 ohms (22K)
6,800 ohms (6.8K)	8,200 ohms (8.2K)

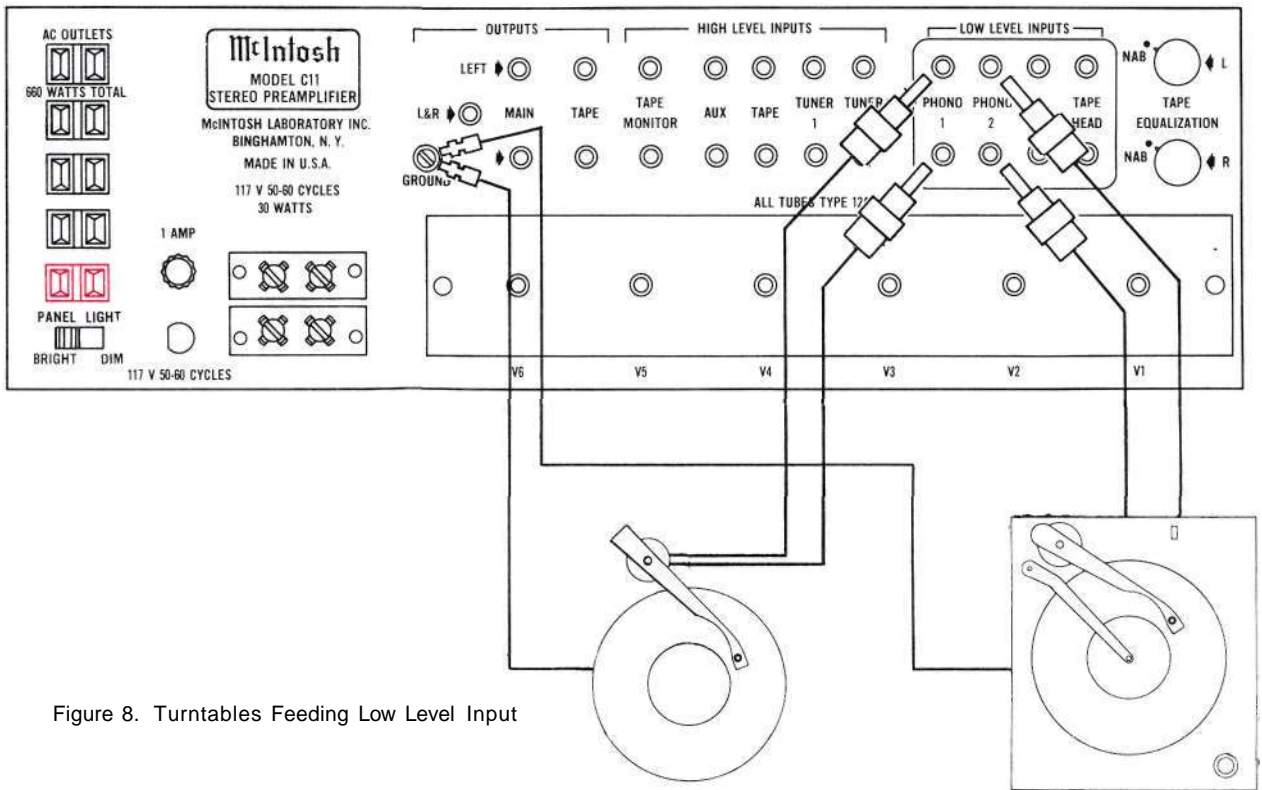

Figure 8. Turntables Feeding Low Level Input

OUTPUT CONNECTIONS

Two sets of outputs, located in the upper left-hand corner of the back panel, are provided. (See Figure 2.)

The MAIN output connects to power amplifiers (Figure 9) and the TAPE output to feed a tape recorder.

The MAIN and TAPE output jacks are fed from cathode followers. The input impedance of devices connected to these outputs should be 50,000 ohms or greater, and the capacitive reactance of audio cables connecting these devices should not be less than 8,000 ohms at 20,000 cycles. This is the reactance of a capacity of 1,000 mmf. Audio cable having a capacity of 25 mmf per foot may be

40 feet long; 13.5 mmf per foot cable may be 75 feet long.

The tape output is affected only by the INPUT SELECTOR in the AUX, TAPE, TUNER 1, TUNER, or MIC positions.

When the INPUT SELECTOR is turned to PHONO 1 or PHONO 2 inputs then the record compensator is included. When the INPUT SELECTOR is turned to TAPE HD then the record compensator switch should be set at RIAA.

On the back panel there are two TAPE EQUALIZATION controls. These controls should be set to NAB for normal 7.5 inch tape speed machines. Turning the TAPE EQUALIZATION controls clockwise increases the

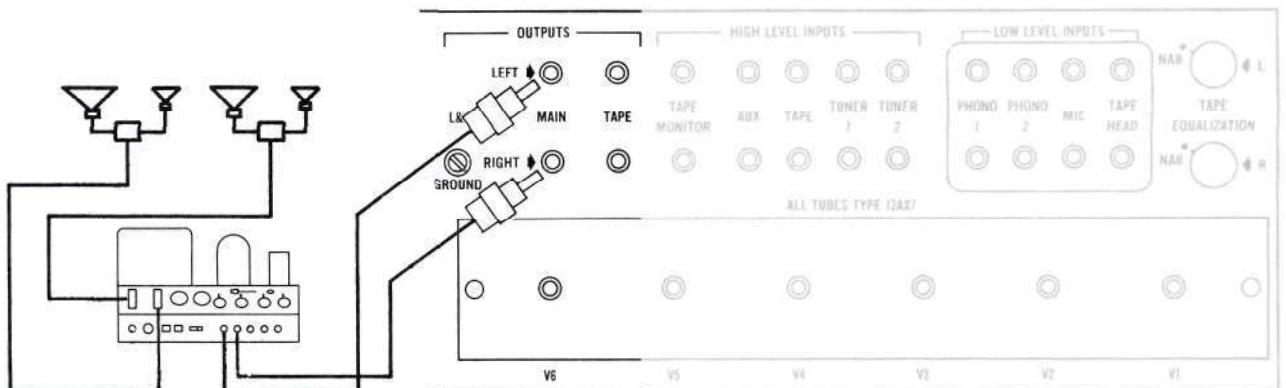

Figure 9. MAIN Output Connected to Power Amplifiers

treble response, turning it counterclockwise decreases the treble response. Use the controls to compensate for 3% tape speed for individual tape head characteristics.

A left plus right output jack is next to the MAIN output. It is marked L+R. A monophonic signal can be distributed to other rooms by connecting a third power amplifier to the jack marked L+R. This amplifier is used to drive the monophonic loudspeakers. The cable connecting to this output should not have a capacity of more than 200 mmf. The input impedance of the power amplifier connecting to this output should not be less than 150,000 ohms (150K). The generator impedance at this output is approximately 25,000 ohms (25K).

LOUDSPEAKER PHASING CONNECTIONS

Two pairs of screw terminals are located on the lower left section of the C11 back panel. The speaker leads from the "left" power amplifier should be connected to the screw terminals marked FROM AMPLIFIER. The pair of terminals marked TO SPEAKER

should be connected to the "left" loudspeaker.

These connections allow the front panel PHASE switch to reverse the phase on the left loudspeaker. This arrangement is convenient when setting up a stereo system.

GROUND CONNECTION

A single ground post is provided. The chassis ground from turntable, record changers (motors used with each), tape decks, etc., should be returned to this post. Do not duplicate this ground circuit. Hum is likely to be heard in the system if duplicate ground returns are used.

The left and right program cables from each source should be twisted together and the ground wire from each source can be wound or twisted in with these cables. To avoid hum, make sure the ground wire does not make any connections to shields of the left and right channel cables except for the connection provided with the C11 ground post.

OPERATING INSTRUCTIONS

BALANCING A STEREO SYSTEM

The ultimate in stereo performance and listening enjoyment is obtained through the proper balancing of the stereo system. A properly balanced stereo system must be in phase. Each channel must be equal in loudness and similar in frequency response.

Do not use the C11 BALANCE control for this procedure. The C11 BALANCE control is used to adjust for any unbalance in the source material, the phono cartridge, and tape machine.

Before attempting the balancing of the C11 make sure the controls on the amplifiers are set properly. On the MC240 and MC275 turn the control marked BALANCE to its center position. On the MC225 set the input level controls for each channel to the black dot above the control.

To properly balance the C11, proceed as follows: A familiar recording, either stereophonic or monophonic, should be used in balancing the C11.

1. Turn the INPUT SELECTOR to the position corresponding to the program selected.
2. Turn the BASS CONTROLS and TREBLE CONTROLS to their 0 positions.

3. Turn the MODE SELECTOR to the L+R TO L position.
4. Place the COMPENSATOR switch in the RIAA position.
5. Place the TAPE switch in the NORMAL position.
6. Place the PHASE switch in the NORMAL position.
7. Place the POWER switch in the ON position.
8. Place the RUMBLE switch in the FLAT position.
9. Place the H.F. cutoff filter switch in the FLAT position.
10. Place the LOUDNESS switch in the NORMAL position.
11. Turn the BALANCE control to the 0 position.
12. While the program is playing, alternate the MODE SELECTOR between the L+R TO L position and the L+R TO R position. Adjust the thumb wheel level controls under the end caps until the loudspeakers are of equal loudness.

When the proper balancing of the McIntosh C11 is accomplished, the stereo system will remain balanced throughout all modes of operation.

ADJUSTING PHASE

1. Place the COMPENSATOR switch in the RIAA position.
2. Set the MODE SELECTOR to STEREO.
3. Turn the BASS CONTROLS and TREBLE CONTROLS to 0.

Stand approximately 10 feet in front of and midway between the loudspeakers. The source of sound should appear to be directly in front of you. Alternate the PHASE switch between NORMAL and REVERSE. If the sound is not directly in front of you in the NORMAL position, reverse the leads to one loudspeaker. The PHASE control is used to correct phase in the source material whenever necessary.

LISTENING TO A STEREO RECORD

Upon completion of the connecting and balancing instructions, the C11 is ready for use. To listen to stereo records, proceed as follows:

1. Set the MODE SELECTOR to STEREO.
2. Set the PHASE switch to NORMAL.
3. Set the H.F. cutoff filter to FLAT.
4. Set the LOUDNESS control to NORMAL.
5. Rotate the INPUT SELECTOR to PHONO 1 or PHONO 2 whichever is connected to the cartridge you wish to hear.
6. Set the COMPENSATOR control to RIAA.
7. Set the BASS CONTROLS and TREBLE CONTROLS to 0.
8. Place the RUMBLE control in the FLAT position.
9. Place the TAPE control in the NORMAL position.
10. Adjust the VOLUME control to the desired volume.

ADJUSTING BALANCE CONTROL AFTER THE SYSTEM HAS BEEN BALANCED

If after balancing your system as outlined in this manual you then find that nearly all

records always require an adjustment of the BALANCE control to one side of the center, the condition indicates an unbalanced stereo cartridge. While this is no great disadvantage as such, you can correct for it by offsetting one of the power amplifier input gain settings. When switching from STEREO to STEREO REV you will now experience a change in volume as a result of this correction.

If the stereo sound seems to come from either side of the room instead of being distributed between the loudspeakers, adjust the PHASE control to 180°. This listening effect is due to reproducing sound that is out of phase from one channel to the other. You will find some records differ from others in this respect and that some tapes differ from records.

ADJUSTING FOR SPECIAL EFFECTS

H.F. Cutoff Filter. If you wish to reproduce old, badly worn records, you can minimize the surface noise by switching the H.F. cutoff filter to the FILTER position. (See section entitled "Front Panel Facilities.")

Rumble Filter. If you are using a turntable or changer which has low-frequency rumble noise, you may reduce it by pushing the RUMBLE filter switch to the FILTER position.

Bass Controls and Treble Controls. The tone balance which you hear when listening to an orchestra is affected by the conductor's instructions to his musicians, the acoustical environment in which you are listening, and your own subjective hearing interpretation. Tone balance will even depend on the room or hall where you listen to the music. Considering these conditions, it is easy to see why tone balance controls play a major role in correcting for the following factors:

1. Each person's subjective idea of tone balance.
2. Loudspeaker frequency response characteristics.
3. Loudspeaker placement in the listening room.

4. The conductor's idea of tone balance at the time the recording was made.

5. The microphone frequency response characteristics.

6. The recording process influences.

These factors can be considered as environmental influences. The BASS CONTROLS and TREBLE CONTROLS are designed to provide a degree of compensation for effects of environment. Listen to your system with each control set to zero. If you wish to reduce treble in relation to bass, rotate the TREBLE CONTROLS counterclockwise until the tone balance sounds correct to you. These controls will modify tone balance without introducing any undesirable effects. Do not be surprised if you find your preference in tone changing from time to time.

Compensator. The COMPENSATOR control is used to correct for the necessary program equalization which the recording process introduces. Recording requires a change in the distribution of intensity with frequency. Without compensation a magnetic cartridge would sound deficient in the bass range and overly bright or shrill in the treble range.

Loudness. Due to a selective shift in sensitivity of human hearing, music reproduced at very low volume loses its bass and treble.

The LOUDNESS switch on the C11 changes the VOLUME control to a loudness control to correct for this effect. When you wish to listen to music at a greatly reduced loudness level and yet hear bass and treble, set the LOUDNESS switch to the COMPENSATED position.

USING THE C11 WITH A STEREO TUNER

1. Turn the INPUT SELECTOR to the position corresponding to the program selected.
2. Turn the BASS CONTROLS and TREBLE CONTROLS to their 0 positions.
3. Turn the MODE SELECTOR to STEREO.
4. Place the TAPE switch in the NORMAL position.
5. Place the PHASE switch in the NORMAL position.
6. Place the POWER switch in the ON position.
7. Place the RUMBLE switch in the FLAT position.
8. Place the H.F. cutoff filter switch in the FLAT position.
9. Place the LOUDNESS switch in the NORMAL position.

USING THE C11 WITH A STEREO TAPE MACHINE

A stereo tape machine with its own playback preamplifiers should be plugged into the TAPE INPUTS—not the TAPE HEAD inputs. The information on adjusting the C11 for listening to a stereo tuner will also apply when listening to a tape machine.

USING THE C11 WITH TAPE DECKS

1. Turn the INPUT SELECTOR to the position corresponding to the program selected.
2. Turn the BASS CONTROLS and TREBLE CONTROLS to their 0 positions.
3. Turn the MODE SELECTOR to STEREO.
4. Place the TAPE switch in the NORMAL position.
5. Place the PHASE switch in the NORMAL position.
6. Place the POWER switch in the ON position.
7. Place the RUMBLE switch in the FLAT position.
8. Place the H.F. cutoff filter switch in the FLAT position.
9. Place the LOUDNESS switch in the NORMAL position.

USING THE C11 WITH MICROPHONES FOR STEREO

Microphones in stereo may be used with the C11. The two MIC channels amplify microphone signals. They have a sensitivity of 2 millivolts and an input impedance of 1 megohm. For lower output microphones input transformers should be used to raise the voltage output to the 2 millivolt range.

When the INPUT SELECTOR is turned to the MIC position, the COMPENSATOR control does not operate. All the other controls operate and may be used the same as for any other program source.

LISTENING TO MONOPHONIC RECORDS

If you wish to listen to monophonic records, switch the INPUT SELECTOR to PHONO 1 or PHONO 2. Turn the MODE SELECTOR to the L TO L+R or R TO L+R position. L TO L+R position connects the left input to both loudspeakers. R TO L+R position connects the right input to both loudspeakers.

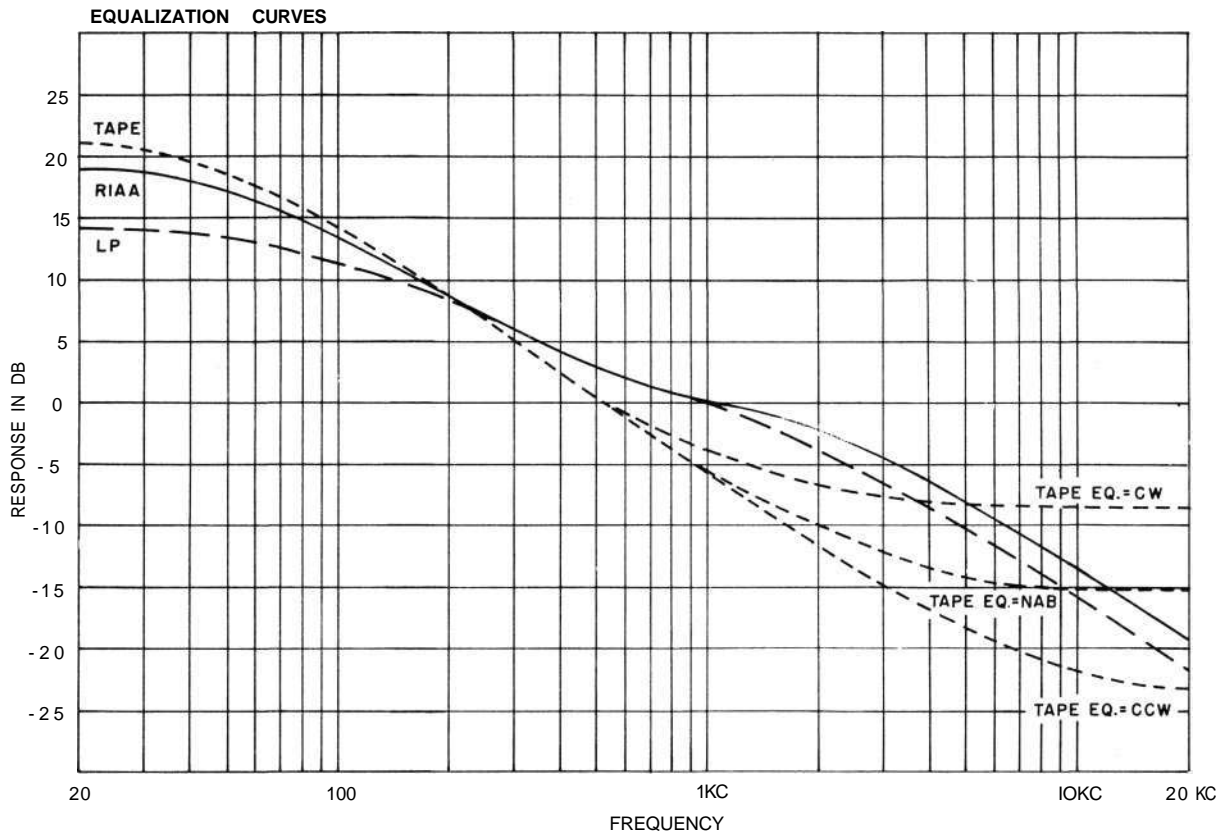

Figure 10. Equalization curves.

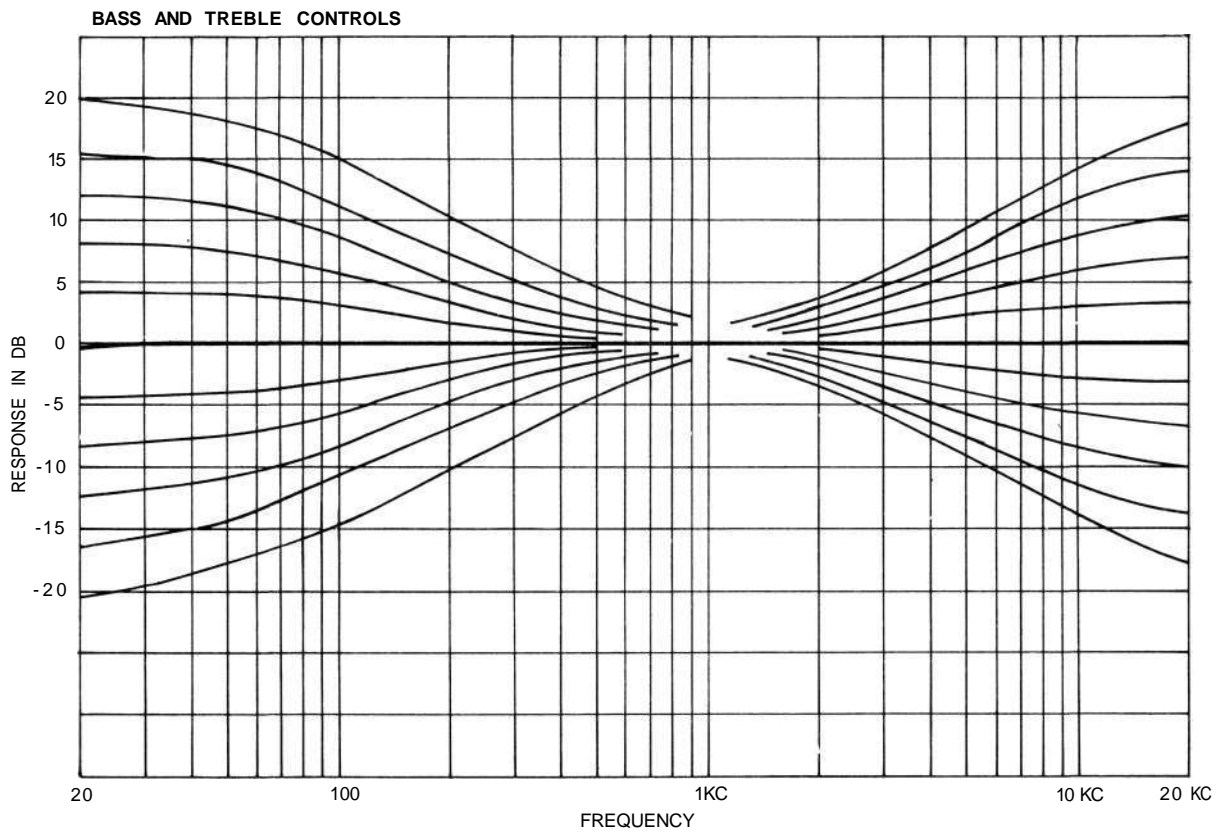

Figure 11. Bass and treble controls.

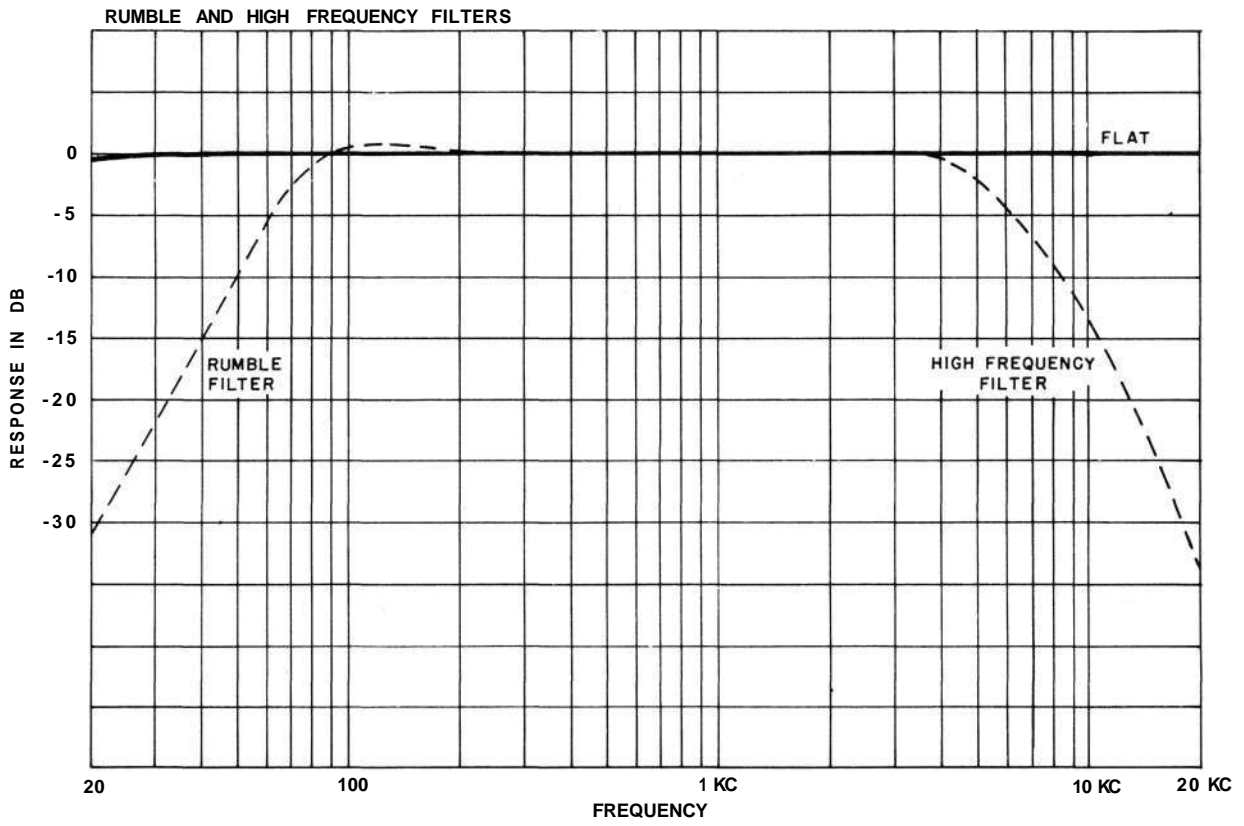

Figure 12. Rumble filter and high frequency filter.

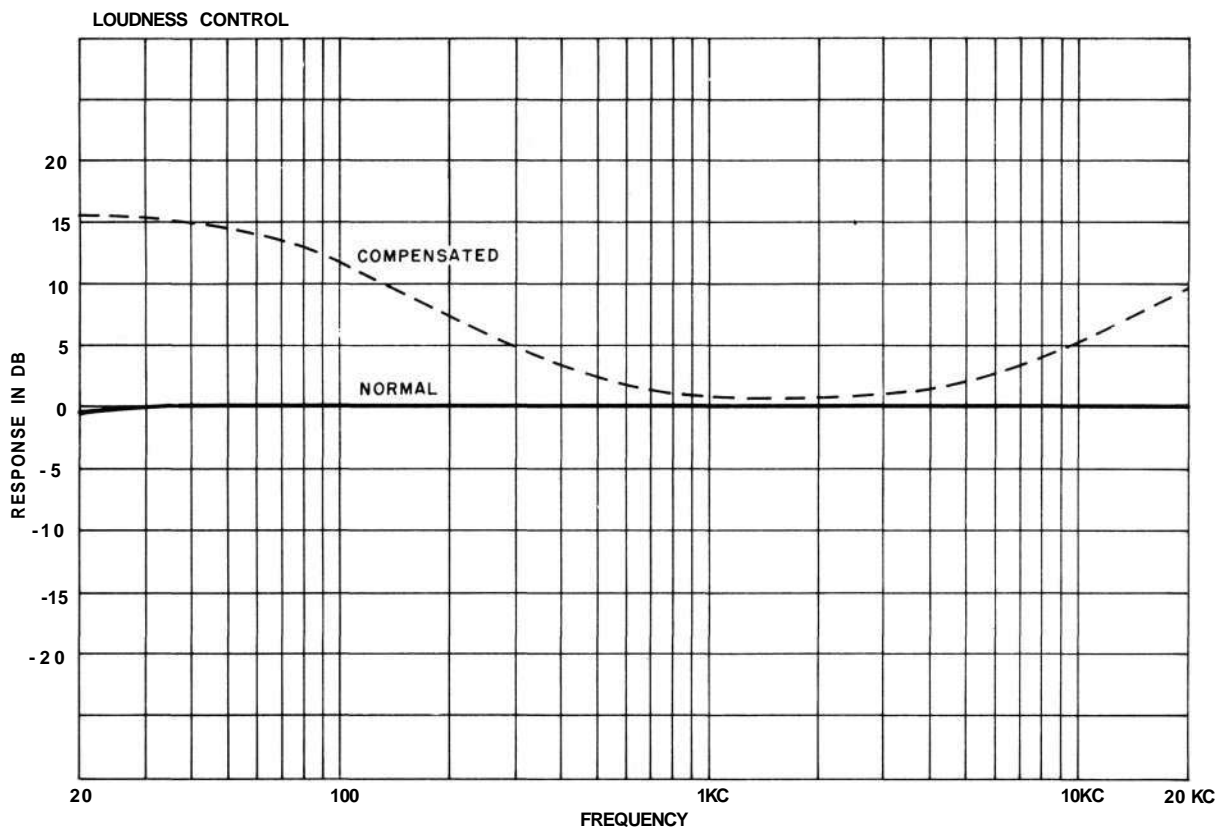

Figure 13. Loudness control.

Your C11 will give you many years of pleasant and satisfactory performance. If you have any questions concerning the operation or maintenance of this preamplifier please contact:

Customer Service
Mcintosh Laboratory Inc.
2 Chambers Street
Binghamton, New York
Our telephone number is 723-5491.
The direct dial area code is 607.

GUARANTEE

Mcintosh Laboratory Incorporated guarantees this equipment to perform as advertised. We also guarantee the mechanical and electrical workmanship and components of this equipment to be free of defects for a

period of 90 days from date of purchase. This guarantee does not extend to components damaged by improper use nor does it extend to transportation to and from the factory.

3-YEAR FACTORY SERVICE CONTRACT

An application for a FREE 3-YEAR FACTORY SERVICE CONTRACT is included in the pocket in the back cover of this manual. The FREE 3-YEAR FACTORY SERVICE CONTRACT will be issued by Mcintosh Laboratory upon receipt of the completely filled out application form. The term of this contract is de-

finied in the 3-year factory service contract. If the application is not mailed to Mcintosh Laboratory, only the services offered under the standard 90-day guarantee will apply on this equipment. TAKE ADVANTAGE OF 3 YEARS OF FREE FACTORY SERVICE BY FILLING IN THE APPLICATION NOW.

In Canada: manufactured under license by:
McCurdy Radio Industries, Ltd.
22 Front Street West
Toronto, Canada

McIntosh LABORATORY INC.

2 CHAMBERS STREET, BINGHAMTON, N. Y.

Made in U.S.A.

Phone-Area Code 607-723-5491