

harman kardon

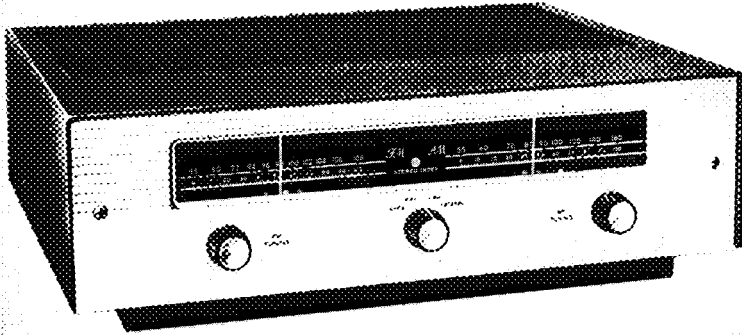

*The Duet*

Model T-224

STEREOPHONIC AM and FM TUNER

## INSTRUCTION MANUAL

It is essential you read this instruction booklet carefully before installing your high fidelity system. You have invested in an extremely fine electronic instrument into which many excellent engineering developments have been incorporated, and each is important for the proper operation of your system. This booklet has been written in simple non-technical language and if you will take the time to read it first before doing anything else, you will find it simple to obtain optimum performance from your Harman-Kardon Model T-224 stereophonic tuner.

Be sure to keep this booklet available at all times. It contains indispensable technical and service information.



*This is the Harman-Kardon Stereo Symbol. It is your assurance of superb stereo performance.*

## **GENERAL DESCRIPTION**

The T-224 stereophonic tuner is extremely versatile and may be used in any of the following ways:

- 1.—Standard monaural AM reception.
- 2.—Standard monaural FM reception.
- 3.—Stereophonic AM and FM reception.
- 4.—FM multiplex stereophonic reception.

### **UNPACKING**

After unpacking the Duet, inspect it carefully for signs of transit damage. The unit was subjected to many inspections and tests at the factory prior to final packing, and it therefore should be in perfect condition. If damage is visible, notify your dealer at once. If the unit was shipped to you, notify the transportation company without delay.

### **MAINTENANCE AND REPAIR**

Due to the conservative design and high quality components of this instrument, no routine maintenance other than yearly tube-checking is required. Should trouble develop, however, only the most qualified service technician should be employed, as special equipment and training is required to properly service a high fidelity unit. This manual contains information of great value to the repairman, and should be kept available.

Factory Warranty Stations are maintained in most major cities. For the address of the nearest one, or for any other information relating to your Harman-Kardon products, write to the attention of the Customer Service Department, Harman-Kardon, Inc., 520 Main Street, Westbury, N. Y. Be sure to include the model and serial number of the set in question. A short description of your complete installation is often of help in answering your questions.

### **WARRANTY POLICY**

**NOTE:** It is necessary to receive factory authorization before returning a set for warranty repair either to the factory or to an authorized station. Repairs are to be returned on an Express Prepaid basis. A letter describing the exact difficulty must be enclosed with the unit.

We warrant this instrument to be free from defects in material and workmanship under normal use and service, and in accordance with the conditions herein below set forth, for a period of one year from date of delivery to the original purchaser, and agree to replace or repair any part or parts, with the exception of tubes which are covered by manufacturer's 90 day warranty, returned to us within said one year with transportation prepaid, and which our examination shall disclose to our satisfaction to have been thus defective. This warranty does not include free labor, nor is it applicable to any instrument which shall have been repaired or altered in any way so as in our judgment to affect its stability or reliability nor which has been subject to misuse, neglect, abuse, negligence or accident, nor which has had the serial number altered, effaced or removed. Neither shall this warranty apply to any instrument which has been connected otherwise than in accordance with the instructions furnished by us.

This warranty is expressly in lieu of all other warranties, express or implied, and of all other obligations or liabilities on our part, and we neither assume nor authorize any representative or other person to assume for us any other liability in connection with the sale of this instrument.

## INSTALLATION PROCEDURE

### Ventilation:

The T-224 stereophonic tuner is well ventilated in itself, but sufficient space must be allowed around it to permit proper air flow. Install the tuner in a manner to allow for unrestricted circulation. Do not place books or other objects on the cage or in the immediate vicinity of the instrument. Reducing the air flow will result in sharply reduced component and tube life.

### Power Requirements:

Plug the AC cord into any outlet furnishing 117 volts, 50 or 60 cycle, AC current. The voltage may vary between 105 and 125 volts. An AC convenience receptacle is located on the rear panel and is controlled by the on/off switch.

### REAR PANEL CONNECTIONS

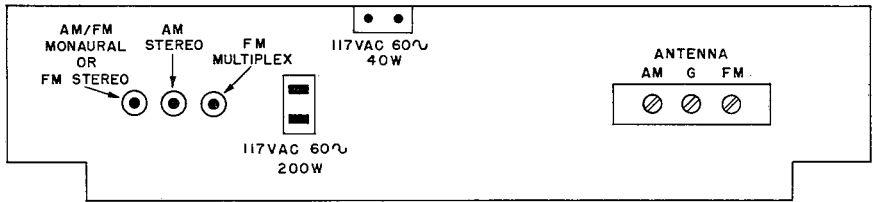

REAR PANEL

### Audio Output:

Three Audio Output receptacles are located on the rear of the chassis. They are used to connect the tuner to the amplifier for either monaural, AM and FM stereophonic, or FM Multiplex stereophonic use.

### Connecting For AM or FM Monaural Operation:

To use the T-224 as a conventional monaural tuner, connect a 3 to 4 foot shielded cable between the jack marked AM/FM MONAURAL and the TUNER or AUX input jack on your amplifier. This will allow either AM or FM reception as selected by the FUNCTION switch located on the front panel of the tuner.

### Connecting for AM/FM Stereophonic Operation:

To use the T-224 as a stereophonic tuner, connect a 3 to 4 foot shielded cable between the FM STEREO jack on the rear panel and the LEFT channel TUNER input jack on your Harman-Kardon stereo amplifier. Another 3 to 4 foot shielded cable must be connected between the AM STEREO output jack on the rear panel of the tuner and the RIGHT channel TUNER input jack on the stereo amplifier.

If you are using two separate amplifiers rather than an integrated stereo unit, the FM STEREO jack on the rear panel of the T-224 connects to the TUNER or AUX input on your first amplifier and the AM STEREO jack on the T-224 connects to the TUNER or AUX input on your second amplifier.

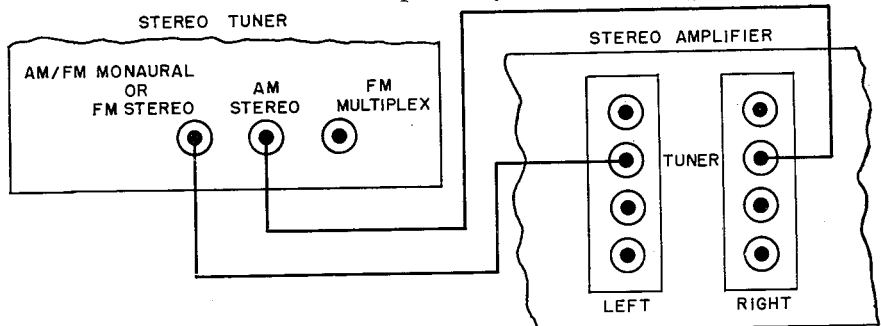

### Connecting for FM Multiplex:

In those localities where FM multiplex broadcasting is available, attach your multiplex adapter to the jack on the rear of the T-224 tuner marked FM MULTIPLEX. The output from the multiplex network is then connected to the RIGHT

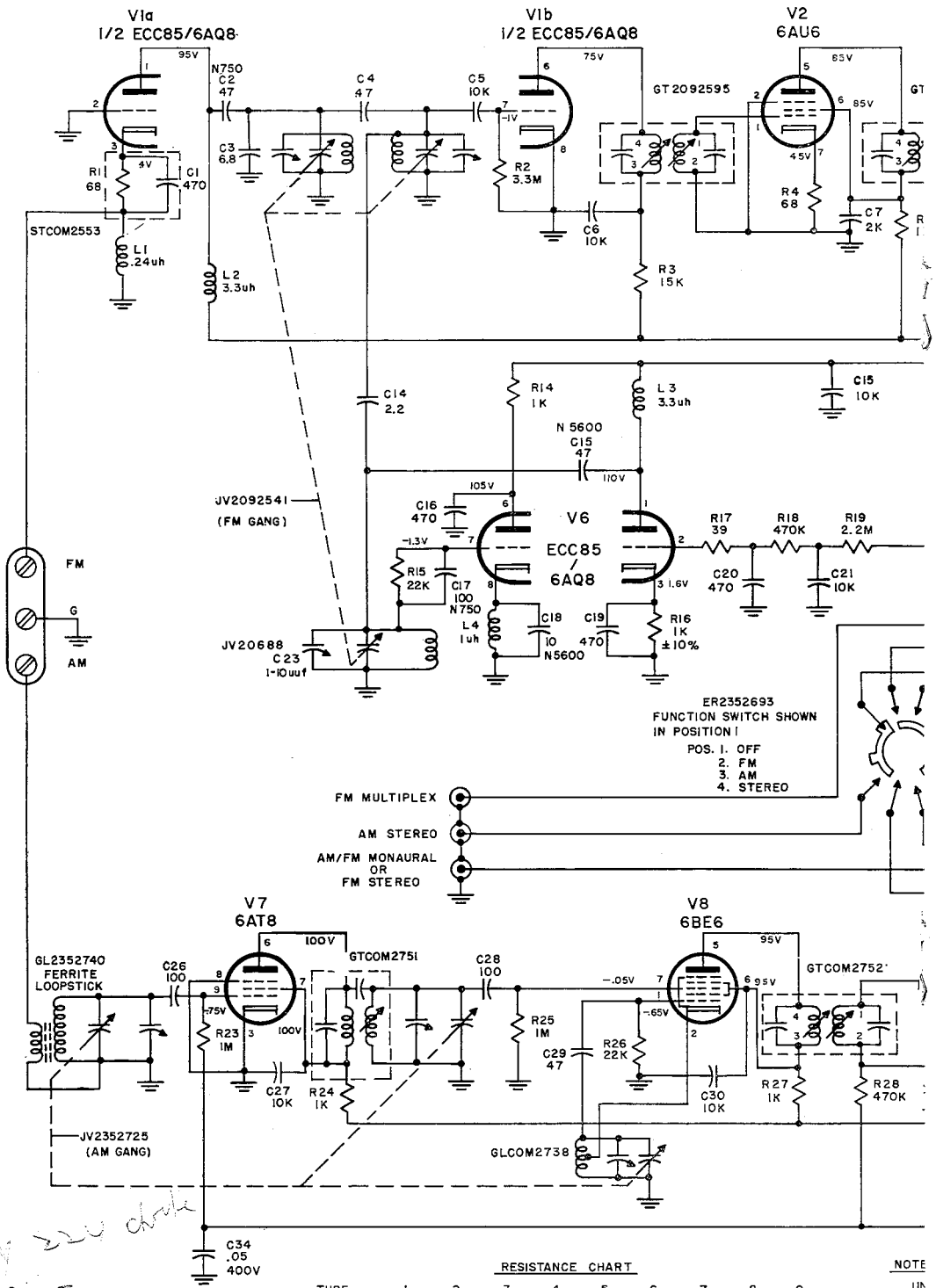

RESISTANCE CHART

TUBE	1	2	3	4	5	6	7	8	9
V1 ECC85	100K	0	68	0	0	100K	3.3M	0	0
V2 6AU6	2.5	0	0	0	100K	100K	68	—	—
V3 6AU6	.3	0	0	0	100K	100K	68	—	—
V4 6AU6	100K	0	0	0	100K	100K	0	—	—
V5 6AL5	0	180K	0	0	360K	0	180K	—	—
V6 ECC85	100K	3.5M	1K	0	0	100K	2.2K	0	0
V7 6AT8	∞	∞	0	0	0	100K	100K	0	4M
V8 6BE6	22K	.2	0	0	100K	100K	1M	—	—
V9 6BA6	470K	0	0	0	250K	250K	0	—	—

NOTE

UP  
AL  
AL  
TC  
AL  
TC  
IN  
AL  
AL

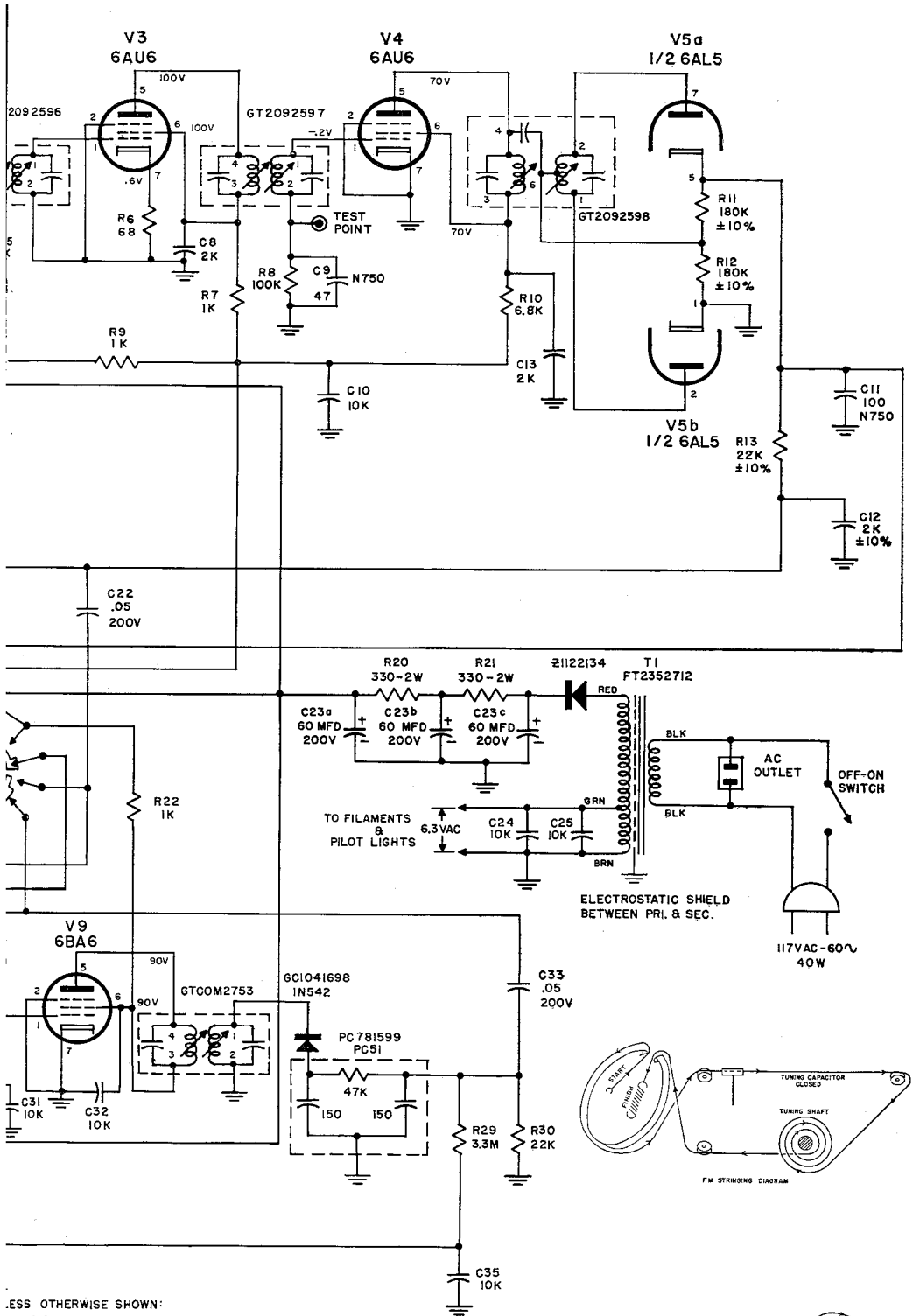

LESS OTHERWISE SHOWN:  
 . RESISTORS 1/2 WATT ±20%.  
 . CAPACITOR VALUES WITH DECIMAL POINT BE PAPER IN MFD.  
 . CAPACITOR VALUES WITHOUT DECIMAL POINT BE GENERAL PURPOSE CERAMICS 500 WVDC, MMF.  
 . VOLTAGES ARE DC.  
 . RESISTANCES ARE IN OHMS.

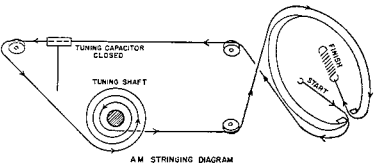
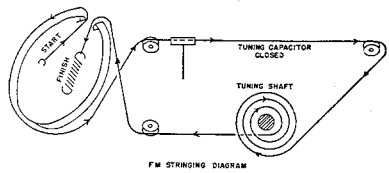

TUNER input on your stereo amplifier. Now connect a shielded lead from the FM STEREO output jack also located on the rear panel of the T-224, to the LEFT TUNER input jack on your stereo amplifier. See diagram below:

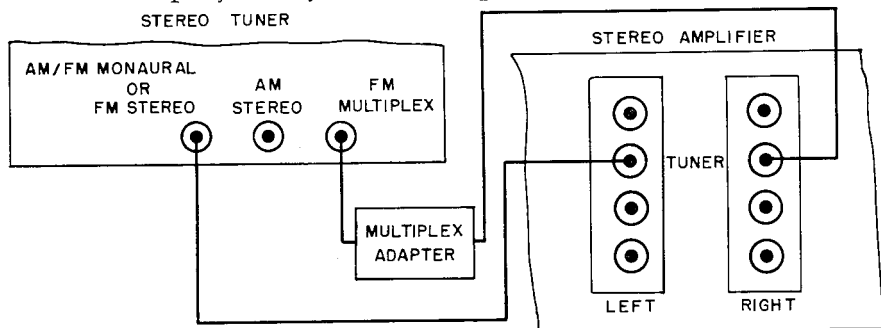

This is only one method of FM multiplexing. It is suggested you follow the instructions supplied with your multiplex adapter for exact hookup information.

An auxiliary AC convenience receptacle is located on the rear of the chassis. You may connect the AC plug on your multiplex adapter to this receptacle.

### Connecting the FM Antenna:

Due to the high FM sensitivity of the T-224 tuner, the 48" piece of wire supplied with the set will be sufficient antenna for all but the most difficult locations. One end of this wire should be fastened to the FM terminal on the Antenna Terminal Strip, and the other end left free and extended as may be convenient. It may be tacked or stapled to the rear of the bookcase or equipment cabinet, if necessary.

If an outdoor antenna is needed, use a folded dipole or Yagi, cut for the FM band. While a TV antenna is at times acceptable, for the best possible reception an FM antenna should be used. Attach the 300 ohm lead-in wire to terminals FM and G on the rear of the T-224 tuner.

### Connecting the AM Antenna:

The ferrite loopstick built into the T-224 stereo tuner comprises all the antenna required for good signal areas. In more remote locations an additional outdoor antenna may be required. This should consist of a single wire, as long as is reasonably practical. It must be kept away from large metal objects, power lines or electrical machinery to insure reception without extraneous noise.

Connect one end of the outdoor antenna wire to the rear Antenna Terminal marked AM.

## OPERATING INSTRUCTIONS

The T-224 stereophonic tuner incorporates the following operating controls located on the front panel. Viewing the instrument from left to right you will note the FM TUNING control to select FM stations, the FUNCTION selector switch (positions are: OFF, FM, AM and STEREO) to select the desired type of program source, and the AM TUNING control to select AM stations.

### Monaural Operation:

Turn the tuner on by setting the FUNCTION selector switch to either the FM or AM position. FM or AM stations may now be tuned in with the appropriate tuning control.

### Stereophonic Operation:

For AM/FM stereophonic reproduction it is necessary to separately tune the FM and AM stations. To facilitate this, set the FUNCTION selector switch to FM and carefully tune to the desired station. Now set the FUNCTION selector switch to AM and tune to the same program on AM. After carefully tuning the FM and AM bands, set the FUNCTION selector switch to STEREO and adjust the BALANCE control on your Harman-Kardon stereo amplifier for proper sound distribution from the two speakers.

If your system consists of two separate amplifiers instead of an integrated stereophonic unit, adjust the two volume controls for the desired loudness and balance.

### **Indexing the Stations:**

Station Index Pins are supplied with this tuner in order to facilitate station identification. These may be used for monaural or stereo operation.

Tune to your favorite FM and AM stations and insert an Index Pin at the exact spot where each station comes in. The pin inserts directly into the cushion located in front of the dial glass.

You will note the pins come in various colors for easy identification. Use pins of the same color for the AM and FM locations of the same station. This will help you tune to your favorite stations without unnecessary program searching.

### **SERVICE NOTES**

Servicing printed wiring is a relatively simple matter and is no more complicated than servicing conventionally wired circuits. No special tools or skills are required and if you follow the outlined procedure, a repair can be easily made.

Avoid damage to the copper foil. Remove components carefully. If the copper is damaged, the broken spot may be jumped with a small piece of wire or bridged with molten solder.

Avoid damage to the printed board. Do not press the board, especially when changing tubes. The board is sturdy in construction, but may break if proper care is not taken when servicing.

Avoid excessive solder deposits. In some areas on the board, wiring is closely spaced. Be careful not to bridge two leads with excessive solder. This may cause a short or intermittent trouble.

Avoid overheating. Use an iron rated at 35 watts or less and do not hold the iron to the connection for a longer period of time than necessary.

Tools and materials required: low wattage iron, small wire brush, 60% tin - 40% lead low temperature solder-rosin core, thin bladed knife and a small pick or soldering aid.

### **FM SPECIFICATIONS:**

Sensitivity:	7 $\mu$ V (30 db quieting) 3.5 $\mu$ V (20 db quieting)
Selectivity:	240 KC Bandwidth: 6 db down.
Discriminator Peak to Peak	0.6 megacycles.
Frequency Range:	88-108 M.C.
Drift:	$\pm$ 5 KC Maximum.
Image Rejection:	40 db.
IF Rejection:	60 db.
Antenna Input:	300 ohms.
Distortion:	Less than 0.5% IM at 30% modulation. Less than 3% IM at 100% modulation.
Frequency Response:	$\pm$ 0.75 db 30-15,000 c.p.s. including de-emphasis.
Hum Level:	60 db below 100% modulation.
Radiation:	Within FCC requirements.
Output Level:	1.5 V. for 100% modulation. 0.5 V. for 30% modulation.
Output Impedance:	High impedance.
Outputs (Rear Panel):	(Total 3) AM-FM Monaural and FM Stereo, AM Stereo and FM Multiplex

### **AM SPECIFICATIONS:**

Sensitivity:	80 $\mu$ V per meter. Terminal sensitivity 10 $\mu$ V.
Selectivity:	10 KC Bandwidth: 6 db down.
Frequency Range:	530-1640 KC.
Image Rejection:	55 db.
IF Rejection:	55 db.
Hum Level:	55 db below 80% modulation.

Antenna Input: Built-in low noise ferrite loopstick with low impedance terminal for external antenna.

Distortion: 3% IM, 1% harmonic.

Frequency Response:  $\pm 3$  db 20-4,000 cycles.

**OVERALL SPECIFICATIONS:**

Controls: (Total 3) FM tuning, function selector (off, FM, AM, stereo) and AM tuning.

Convenience AC Receptacle: One (switched).

Tube Complement: (Total 9) 2-ECC85, 3-6AU6, 1-6AL5, 1-6AT8, 1-6B6, 1-6BA6.

Dimensions: 13-13/16" W x 12-1/4" D x 4-3/8" H

Power Consumption: 40 watts @ 117 volts, 60 cycles.

Finish: Escutcheon: Copper-anodized aluminum.  
Cage: Black.

Weight: 13 lbs.

### ALIGNMENT PROCEDURE

FUNCTION SWITCH SETTING	SIGNAL GENERATOR		SIGNAL INPUT POINT	OUTPUT INDICATOR	CONNECT INDICATOR TO:	DIAL SETTING	ADJUST	OUTPUT INDICATION
	FREQ.	MOD.						
FM	10.7 MC	300 KC FM 60 CPS	FM MIXER GANG	AC-VTVM OR SCOPE	TEST POINT		3 FM IF TRANS. DISCR. TRANS.	MAX GAIN & SYMMETRY S PATTERN OF MAX GAIN & SYMM.
FM	10.7 MC	300 KC FM 60 CPS	FM MIXER GANG	AC-VTVM OR SCOPE	TUNER OUTPUT			
FM	106 MC	300 KC FM 60 CPS	FM ANT. TERMINAL	AC-VTVM OR SCOPE	TEST POINT	106 MC	106 MC OSC RF. MIXER TRIMMERS	MAXIMUM OUTPUT
FM	90 MC	300 KC FM 60 CPS	FM ANT. TERMINAL	AC-VTVM OR SCOPE	TEST POINT	90 MC	OSC. RF. MIXER COILS	MAXIMUM OUTPUT

FUNCTION SWITCH SETTING	SIGNAL GENERATOR		SIGNAL INPUT POINT	OUTPUT INDICATOR	CONNECT INDICATOR TO:	DIAL SETTING	ADJUST	OUTPUT INDICATION
	FREQ.	MOD.						
AM	455 KC	30% AM	AM RF GANG	AC-VTVM OR SCOPE	TUNER OUTPUT	1600 KC	2 AM IF TRANS.	MAXIMUM OUTPUT
AM	1400 KC	30% AM	AM ANT. TERM.	AC-VTVM OR SCOPE	TUNER OUTPUT	1400 KC	OSC. ANT & RF TRIMMERS	MAXIMUM OUTPUT
AM	600 KC	30% AM	AM ANT. TERM.	AC-VTVM OR SCOPE	TUNER OUTPUT	600 KC	OSC COIL LOOPSTICK & RF TRANS	MAXIMUM OUTPUT
AM	1400 KC				REPEAT STEP 2			

### LIST OF REPLACEABLE PARTS

Description	Harman-Kardon Part No.	List Price
TINNERMAN PUSH ON CLIP	STCOM2783	.05
75MA RECTIFIER	Z1122134	2.15
ELECTROLYTIC CAPACITOR 60/60/60 MFD-200 VDC	JE2352713	2.75
POWER TRANSFORMER	FT2352712	8.10
FUNCTION SWITCH	ER2352693	2.00
DIAL GLASS	P2352742	1.05
LOOPSTICK ANTENNA	GL2352740	1.75
LOOPSTICK TUNING RING	P481329	.05
GERMANIUM DIODE	GC1041698	1.25
ESCUTCHEON	P2352659	4.40
KNOB	PCOM2840	.25
MAPTACK SET	A2352853	.50
VARIABLE CONDENSER	JV2092541	4.50
OSC TRIMMER	JV20688	.30
1st FM IF TRANSFORMER	CT2092595	1.55
2nd FM IF TRANSFORMER	CT2092596	1.55
3rd FM IF TRANSFORMER	CT2092597	1.55
FM DISCRIMINATOR TRANSFORMER	CT2092598	2.00
AM OSC COIL	GLCOM2738	.60
AM RF TRANSFORMER	CTCOM2751	2.50
1st AM IF TRANSFORMER	CTCOM2752	1.35
2nd AM IF TRANSFORMER	GTCOM2753	1.35

7224