

12. 6 CONTROL AMPLIFIER ASSEMBLY (AWG-027-0)

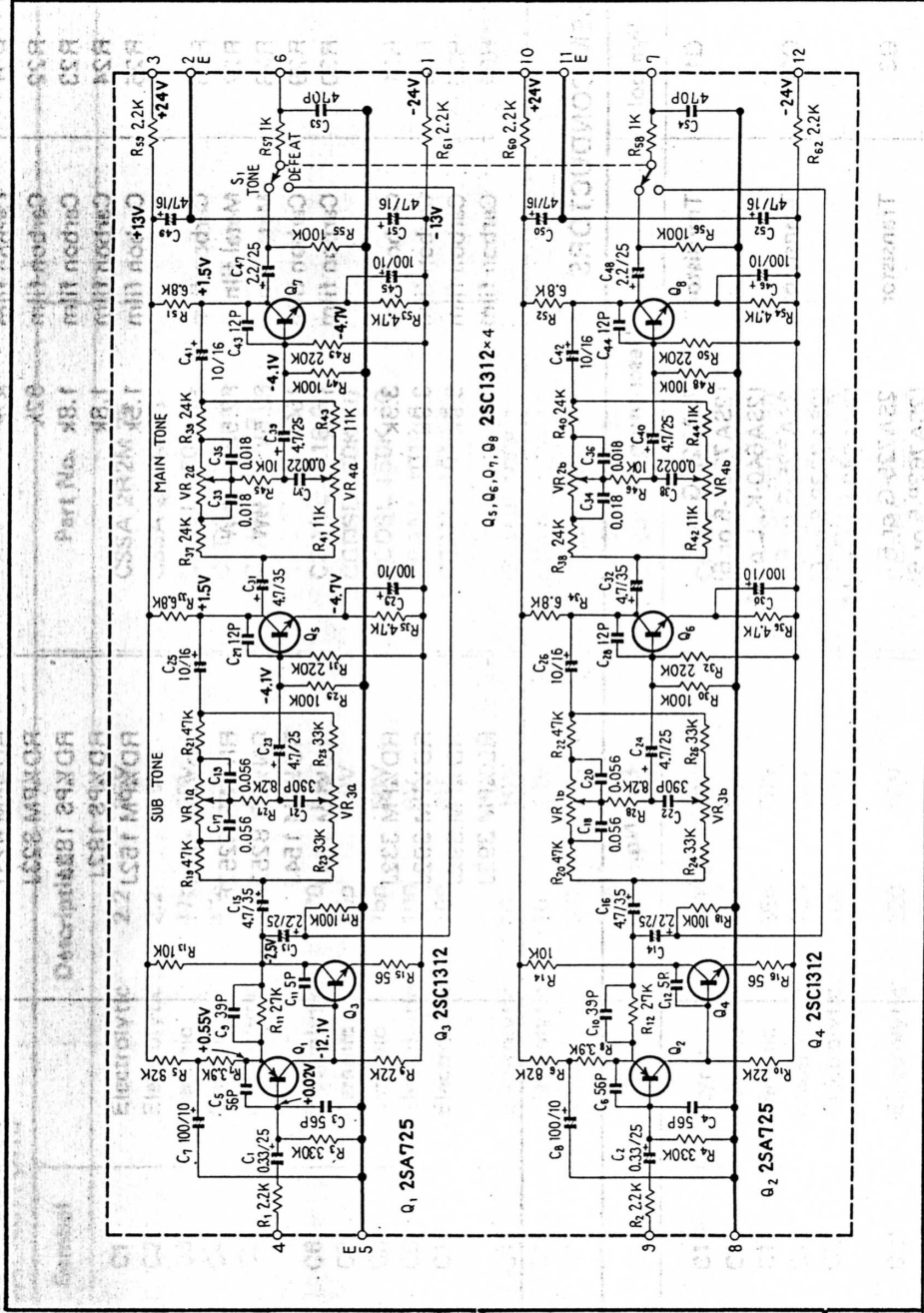

Foil Side

SX-1010

12.7 POWER AMPLIFIER ASSEMBLY (AWH-032-0)

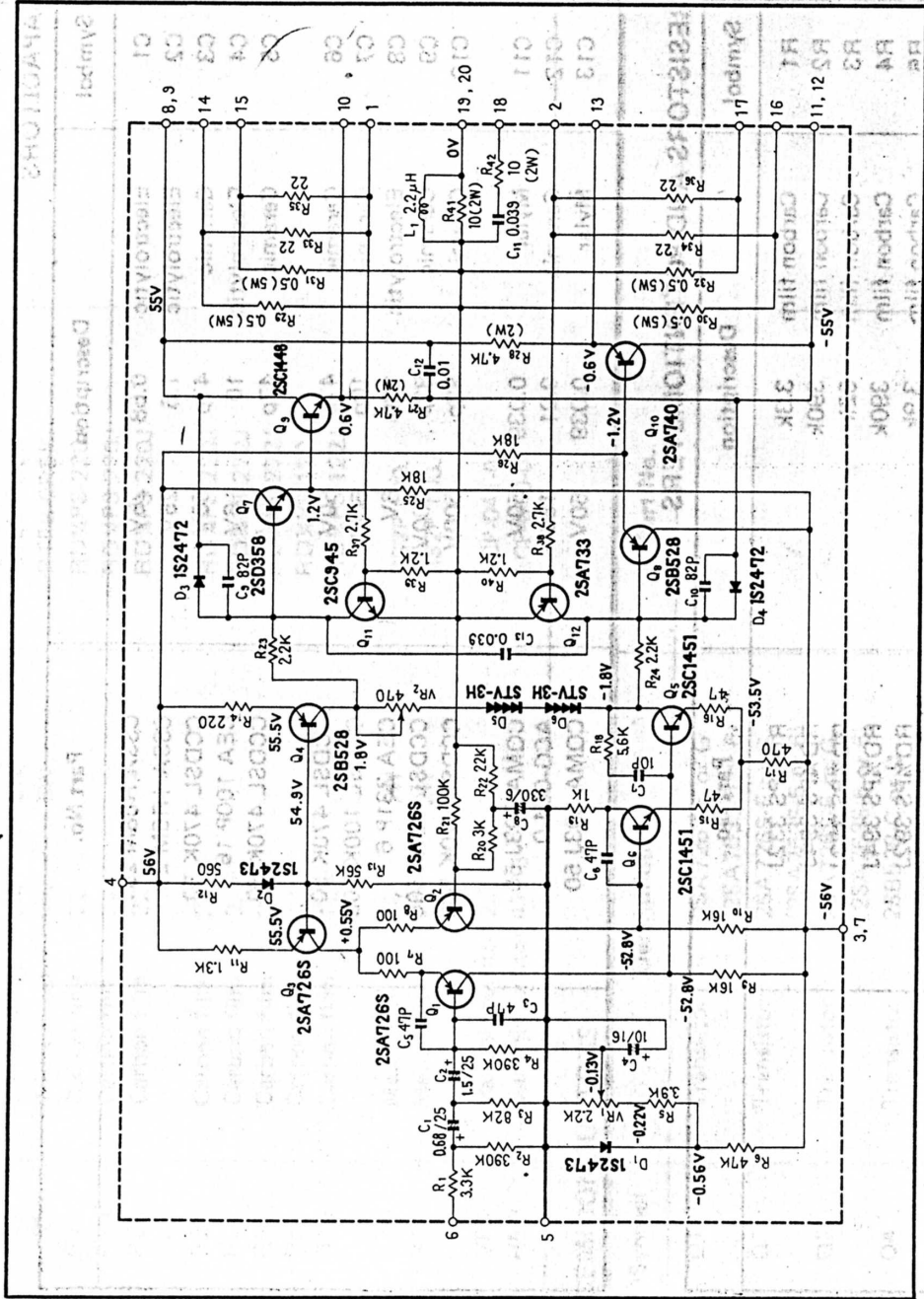

Foil Side

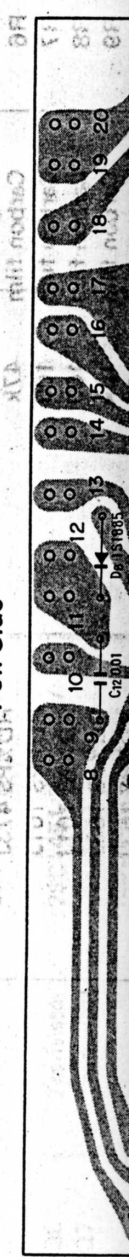

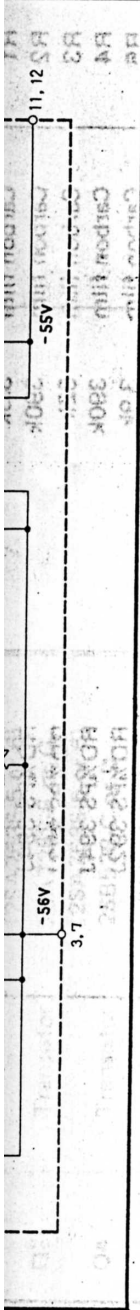

Foil Side

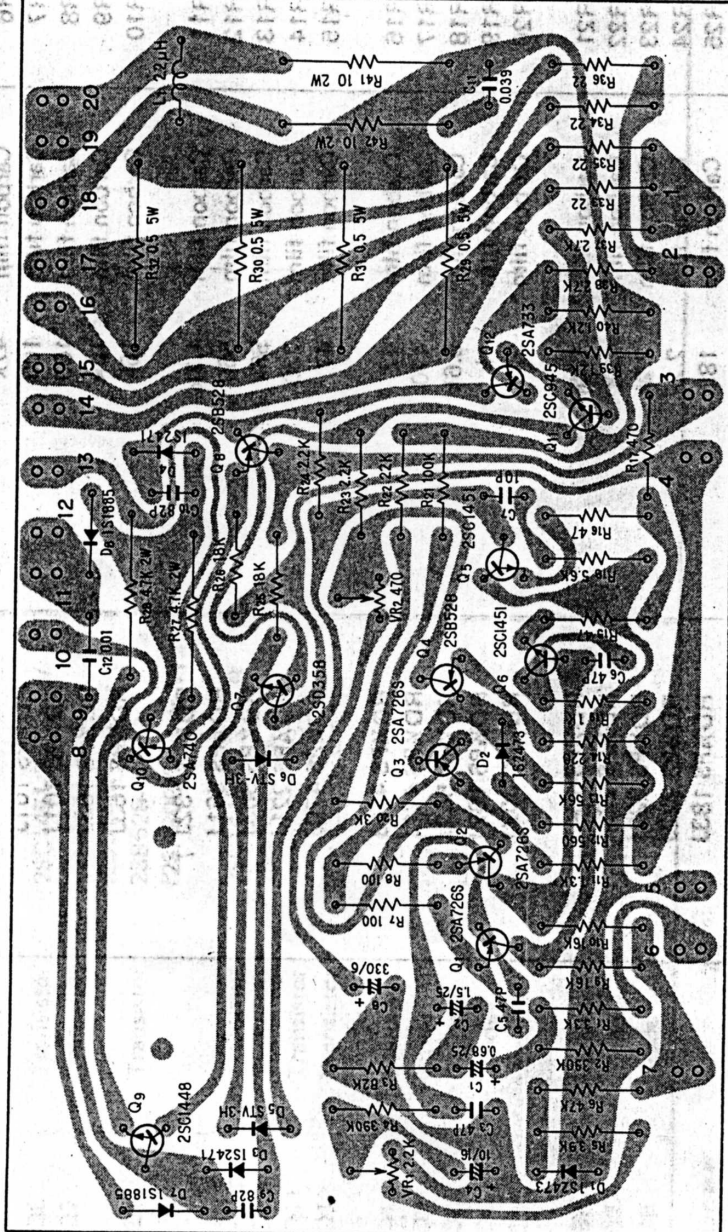

- 2SA726S
- 2SB528 OR
- 2SD358
- 2SC1451
- 2SA733
- 2SC945
- 2SC1448
- 2SA740

0101-302

12. 8 PROTECTION CIRCUIT ASSEMBLY (AWM-062-0)

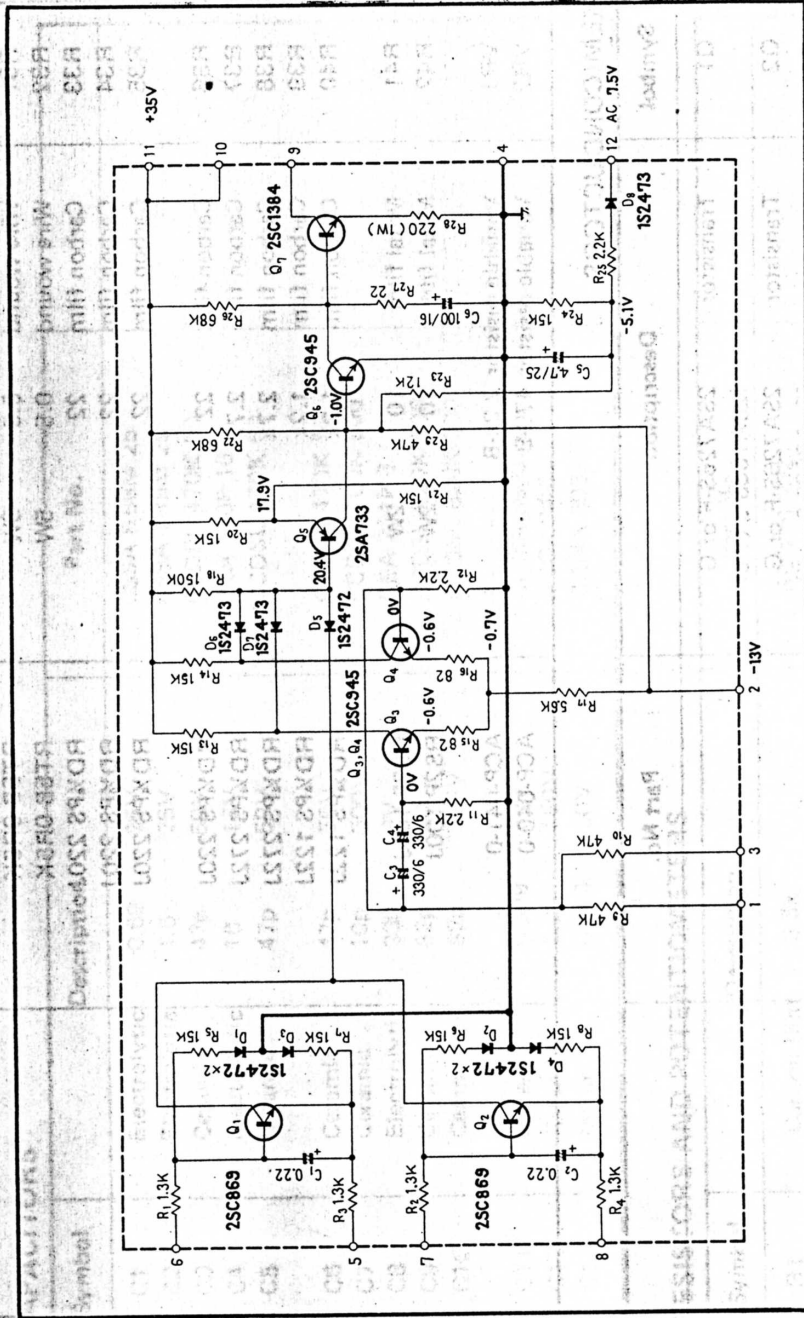

Foil Side



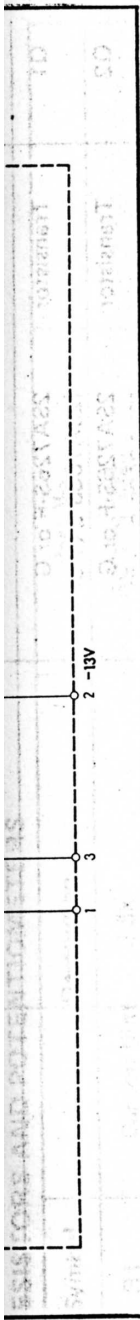

Foil Side

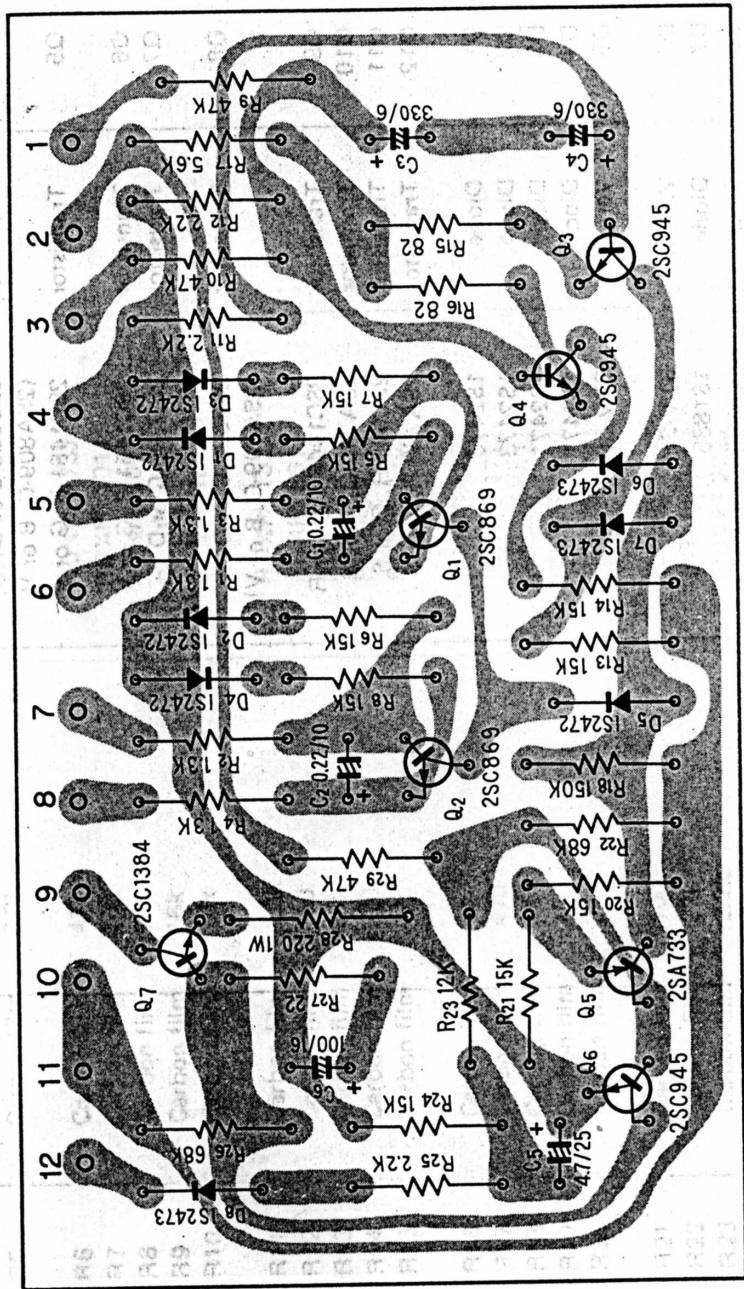

2SC869

2SA733

2SC945

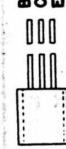
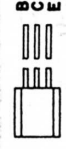
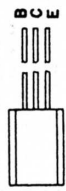

SX-1010

12.10 POWER SUPPLY CIRCUIT ASSEMBY (AWR-054-A)

- 2SD313P
- 2SD313
- 2SB507P

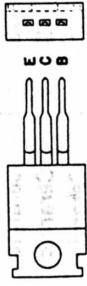

2SC869



2SC1384



2SA628A

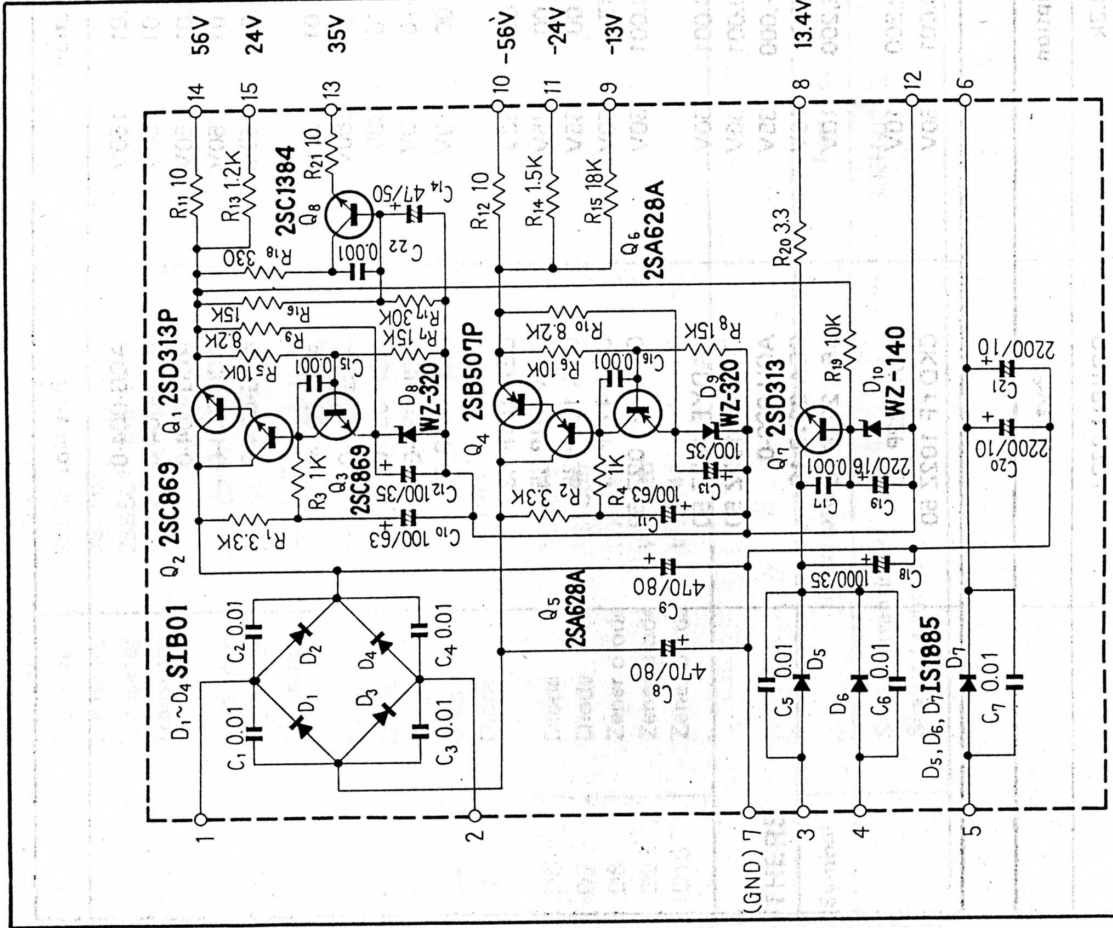

RESISTORS
 2SD313P
 2SD313
 2SB507P
 2SC869
 2SC1384
 2SA628A
 SIB01
 WZ-320
 WZ-140
 IS1885

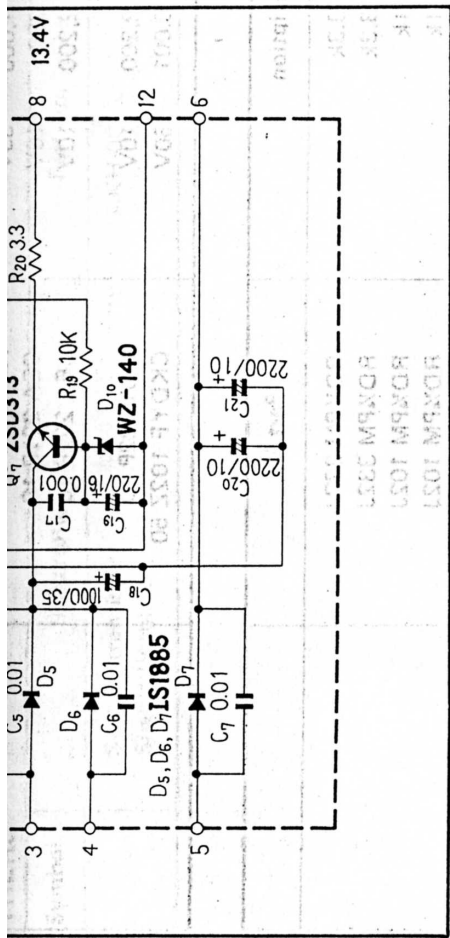

Foil Side

