

Operating Instructions

AUDIO/VIDEO STEREO RECEIVER

VSX-403

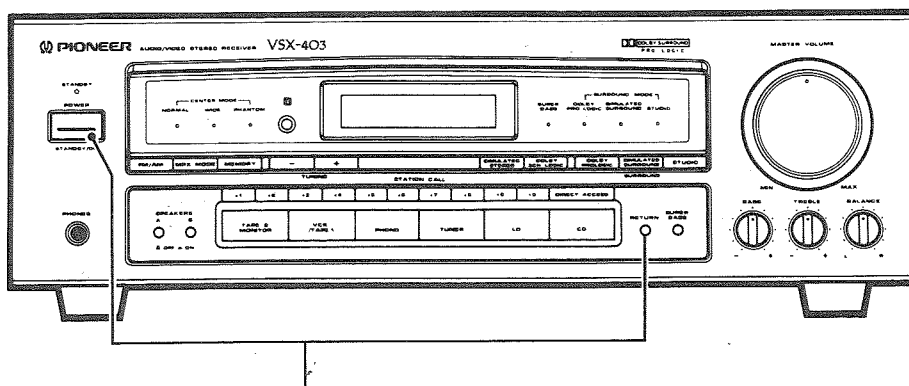

Demonstration mode

- The demonstration mode is activated by turning on the power switch while holding down the RETURN button (from the power standby condition). The demonstration will appear on the display.
- Press any other button to cancel the demonstration.

Thank you for buying this Pioneer product.

Please read through these operating instructions so you will know how to operate your model properly. After you have finished reading the instructions, put them away in a safe place for future reference.

In some countries or regions, the shape of the power plug and power outlet may sometimes differ from that shown in the explanatory drawings. However, the method of connecting and operating the unit is the same.

WARNING: TO PREVENT FIRE OR SHOCK HAZARD, DO NOT EXPOSE THIS APPLIANCE TO RAIN OR MOISTURE.

ATTENTION: AFIN DE PREVENIR TOUS RISQUES DE CHOC ELECTRIQUE OU DE DEBUT D'INCENDIE, NE PAS EXPOSER CET APPAREIL A L'HUMIDITE OU A LA PLUIE.

IMPORTANT NOTICE

The serial number for this equipment is located on the rear panel. Please write this serial number on your enclosed warranty card and keep it in a secure area. This is for your security.

REMARQUE IMPORTANTE

Le numéro de série de cet appareil se trouve sur son panneau arrière. Pour s'y référer en cas de besoin, prière d'inscrire ce numéro sur la carte de garantie incluse et de la conserver dans un endroit sûr. Cela par mesure de sécurité.

CAUTION: TO PREVENT ELECTRIC SHOCK DO NOT USE THIS (POLARIZED) PLUG WITH AN EXTENSION CORD, RECEPTACLE OR OTHER OUTLET UNLESS THE BLADES CAN BE FULLY INSERTED TO PREVENT BLADE EXPOSURE.

ATTENTION: POUR PREVENIR LES CHOCS ELECTRIQUES NE PAS UTILISER CETTE FICHE POLARISEE AVEC UN PROLONGATEUR, UNE PRISE DE COURANT OU UNE AUTRE SORTIE DE COURANT, SAUF SI LES LAMES PEUVENT ETRE INSEREES A FOND SANS EN LAISSER AUCUNE PARTIE A DECOUVERT.

RETURN function

This function returns the unit to a set of initial settings and the tuner ready to receive broadcast. This is helpful during troubleshooting or when no sound is output. For details, refer to page 9.

IMPORTANT



The lightning flash with arrowhead, within an equilateral triangle, is intended to alert the user to the presence of uninsulated "dangerous voltage" within the product's enclosure that may be of sufficient magnitude to constitute a risk of electric shock to persons.



CAUTION:
TO PREVENT THE RISK OF ELECTRIC SHOCK, DO NOT REMOVE COVER (OR BACK). NO USER-SERVICEABLE PARTS INSIDE. REFER SERVICING TO QUALIFIED SERVICE PERSONNEL.



The exclamation point within an equilateral triangle is intended to alert the user to the presence of important operating and maintenance (servicing) instructions in the literature accompanying the appliance.

Information to User

Alteration or modifications carried out without appropriate authorization may invalidate the user's right to operate the equipment.

SAFETY INSTRUCTIONS

READ INSTRUCTIONS — All the safety and operating instructions should be read before the appliance is operated.

RETAIN INSTRUCTIONS — The safety and operating instructions should be retained for future reference.

HEED WARNING — All warnings on the appliance and in the operating instructions should be adhered to.

FOLLOW INSTRUCTIONS — All operating and use instructions should be followed.

WATER AND MOISTURE — The appliance should not be used near water — for example, near a bathtub, washbowl, kitchen sink, laundry tub, in a wet basement, or near a swimming pool, etc.

LOCATION — The appliance should be installed in a stable location.

WALL OR CEILING MOUNTING — The appliance should not be mounted to a wall or ceiling.

VENTILATION — The appliance should be situated so that its location or position does not interfere with its proper ventilation. For example, the appliance should not be situated on a bed, sofa, rug, or similar surface that may block the ventilation openings; or, placed in a built-in installation, such as a bookcase or cabinet that may impede the flow of air through the ventilation openings.

HEAT — The appliance should be situated away from heat sources such as radiators, heat registers, stoves, or other appliances (including amplifiers) that produce heat.

POWER SOURCES — The appliance should be connected to a power supply only of the type described in the operating instructions or as marked on the appliance.

POWER-CORD PROTECTION — Power-supply cords should be routed so that they are not likely to be walked on or pinched by items placed upon or against them. Pay particular attention to cords at plugs, convenience receptacles, and the point where they exit from the appliance.

POLARIZATION — If your purchased product is provided with a polarized power plug, please read the following instructions. This product is equipped with a polarized alternating current line plug (a plug having one blade wider than the other). This plug will fit into the power outlet only one way. This is a safety feature. If you are unable to insert the plug fully into the outlet, try reversing the plug. If the plug should still fail to fit, contact your electrician to replace your obsolete outlet. Do not defeat the safety purpose of the polarized plug.

CLEANING — The appliance should be cleaned only with a polishing cloth or a soft dry cloth. Never clean with furniture wax, benzene, insecticides or other volatile liquids since they may corrode the cabinet.

POWER LINES — An outdoor antenna should be located away from power lines.

NONUSE PERIODS — The power cord of the appliance should be unplugged from the outlet when left unused for a long period of time.

OBJECT AND LIQUID ENTRY — Care should be taken so that objects do not fall and liquids are not spilled into the enclosure through openings.

DAMAGE REQUIRING SERVICE — The appliance should be serviced by a Pioneer authorized service center or qualified service personnel when:

- The power-supply cord or the plug has been damaged.
- Objects have fallen, or liquid has been spilled into the appliance.
- The appliance has been exposed to rain.
- The appliance does not appear to operate normally or exhibits a marked change in performance.
- The appliance has been dropped or the enclosure damaged.

SERVICING — The user should not attempt to service the appliance beyond that described in the operating instructions. All other servicing should be referred to qualified service personnel.

OUTDOOR ANTENNA GROUNDING — If an outside antenna is connected to the antenna terminal, be sure the antenna system is grounded so as to provide some protection against voltage surges and built-up static charges.

In the U.S.A. section 810 of the National Electrical Code, ANSI/NFPA 70, provides information with respect to proper grounding of the mast and supporting structure, grounding of the lead-in wire to an antenna discharge unit, size of grounding conductors, location of antenna discharge unit, connection to grounding electrodes, and requirements for the grounding electrode. See Fig. A.

CART — An appliance and cart combination should be moved with care. Quick stops, excessive force, and uneven surfaces may cause the appliance and cart combination to overturn.



NEC — NATIONAL ELECTRIC CODE

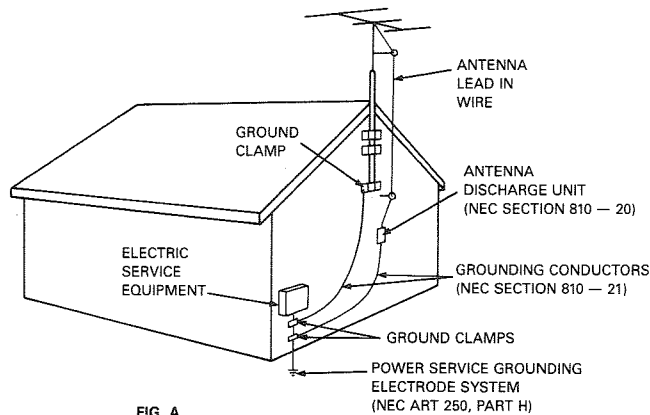
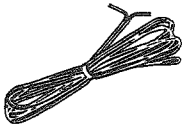
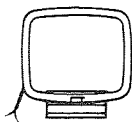

FIG. A

ACCESSORY ITEMS



FM antenna



AM loop antenna



Remote control unit

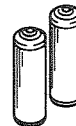

Dry cell batteries
(size "AA" R6/UM-3)

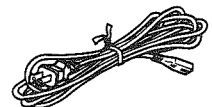

Power cord

CONTENTS

ACCESSORY ITEMS	2	TUNER	11
SURROUND EFFECT	3	DIRECT ACCESS TUNING	11
DOLBY 3CH LOGIC	3	AUTO TUNING	12
DOLBY PRO LOGIC SURROUND, DOLBY 3CH LOGIC CENTER MODE	3	MANUAL TUNING	12
SPEAKER INSTALLATION	4	PRESET TUNING	13
SIMULATED STEREO	4	RECEIVING FM SIMULCAST TV PROGRAMS	13
CONNECTIONS	4	OPERATING THE AUDIO/VIDEO COMPONENTS	14
BASIC AUDIO SYSTEM CONNECTIONS	5	PLAYBACK	14
BASIC VIDEO SYSTEM CONNECTIONS	6	RECORDING WITH A CASSETTE DECK	15
SPEAKER CONNECTIONS	7	DOLBY PRO LOGIC SURROUND AND DOLBY 3CH LOGIC	15
FRONT PANEL FACILITIES	8	HINTS FOR BETTER RECEPTION	16
REAR PANEL FACILITIES	10	REMOTE CONTROL OPERATION	17
		TROUBLESHOOTING	21
		SPECIFICATIONS	23

SURROUND EFFECT

This unit has a built-in surround processor for adding presence and an expansive effect to the sound.

• STUDIO:

Select this position to enjoy the effect of listening to music in a recording studio.

The source sound is output as it is through the front speakers, with reverberation output through the rear speakers.

This is particularly suitable for a source that has a lot of reverberation.

• SIMULATED SURROUND:

The "SIMULATED SURROUND" creates effects of reverberated and reflected sound from the walls and ceiling similar to a concert hall. These sound-effects added to the actual sound from the source make you feel as if you were in a more expanded space. The different ranges of the expanded space can be set by the DELAY TIME button.

Set the Delay Time to 15 ms or 20 ms for a live-house concert. For chamber music, set to 20 ms. For orchestral music, set to 30 ms. The "SIMULATED SURROUND" also gives effects on monaural sources by outputting the reverberated sound from rear speakers while keeping the output sound from front speakers as it is. Turn on the "SIMULATED SURROUND" for a monaural source to gain effective surround playback.

• DOLBY* PRO LOGIC SURROUND:

Choose this setting for movies and music (especially Video Discs and video tapes bearing the  mark) playback. DOLBY PRO LOGIC SURROUND continuously detects the size and direction of the dominant signal and cancels undesirable crosstalk, thereby providing signal emphasis.

It makes you clearly perceive the directions where music comes from. Real flow of sound also can be re-created naturally using this feature. You can feel as if being in the outstanding and expansive sound field.

When using DOLBY PRO LOGIC SURROUND, a delay time setting of 20 ms is commonly used. Use a different setting if you prefer.

Even if they do not bear the  mark, some video recordings may be Dolby Surround encoded.

Choose the SIMULATED SURROUND mode if the source sound signal is mono. Little or no sound will be heard from the surround speakers if the DOLBY PRO LOGIC SURROUND mode is selected.

With DOLBY PRO LOGIC SURROUND, monaural source sound will be heard only from the center channel at settings other than the PHANTOM position.

Note:

Dolby Surround will not operate correctly if the signal passes through a graphic equalizer.

When using Dolby Surround, turn off the TAPE 2 MONITOR or set the graphic equalizer for flat response or to its "through" (or off) setting, if you have one in use.

*

Manufactured under license from Dolby Laboratories Licensing Corporation. Additionally licensed under one or more of the following patents: U.S. numbers 3,959,590; Canadian numbers 1,004,603 and 1,037,877. "Dolby", "Pro Logic", and the double-D symbol are trademarks of Dolby Laboratories Licensing Corporation.

DOLBY 3CH LOGIC

Combining the rear speaker signal with that of the front speakers results in your being able to enjoy a regenerated sound field which has comparatively more presence and a more expansive feeling from the front 3 channels (front L, front R, and center speakers) than that of ordinary stereo regeneration.

DOLBY PRO LOGIC SURROUND, DOLBY 3CH LOGIC CENTER MODE

[For DOLBY PRO LOGIC SURROUND and DOLBY 3CH LOGIC]

You can choose from the following settings:

Center Mode Choices:

When using a center speaker:

- **NORMAL** — Low range frequencies, which have little effect on directionality and positioning, are routed to the left and right front speakers. So you can use a relatively small size speaker as the center speaker.
- **WIDE** — If you use a large size center speaker, choose this setting. The full frequency range of the Dolby Surround center channel, from low to high, is routed to the center speaker.

When not using a center speaker: DOLBY PRO LOGIC SURROUND only

- **PHANTOM** — The signal which would have been sent to the center speaker is divided equally between the left and right front speakers.

SPEAKER INSTALLATION

To get the most out of the surround system, place the speakers as shown below.

An example of speaker positioning

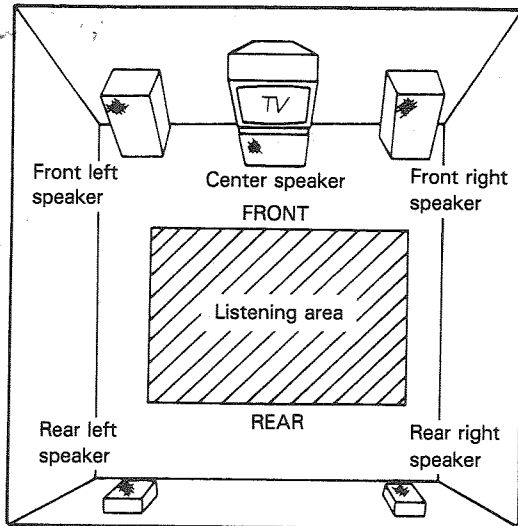

If the rear speakers are positioned at an extreme distance, the surround level becomes unable to adjust and the surround effect will not be fully achieved.

NOTE:

- To avoid interference with the picture on a nearby TV set, use magnetically shielded speaker systems. This is particularly important for the center speaker since it is usually located closest to the TV.
- Position the left and right channel speakers at equal distances from the TV set and approximately 2 meters (6.6 feet) from each other.
- Position the center speaker above, below, or behind the TV set. Sound may not appear to coincide with the picture if you position it next to the TV set.
- Rear speakers are best positioned slightly above ear level.

SIMULATED STEREO

This function transforms monaural signals into simulated stereo sound. Use it when you wish to experience a sense of stereo presence when listening to AM broadcasts, or VCR and other monaural signal sources.

NOTE:

The simulated stereo function can also be used with stereo sound sources, but it will result in an effect somewhat different from the normal stereo sound.

CONNECTIONS

Setting Up the AM Antenna

- Insert the claw on the bottom of the antenna into the hole in the leg.
- Place the antenna on a level surface and rotate it to locate the orientation that yields the best reception.
- Use the attachment hole in the leg to screw to wall or other location, then insert the claw on the bottom of the antenna into the hole in the leg (fixing the antenna in the direction that gives the best reception).

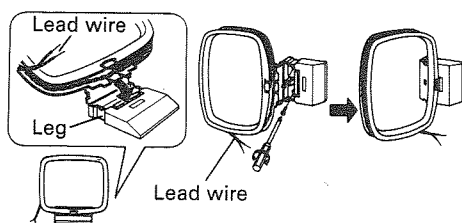

Precaution regarding installation position of cassette deck.

If the cassette tape deck is installed in the (A) positions shown in the drawing below, it may be adversely affected during playback. If possible, it's better to install it in the (B) position.

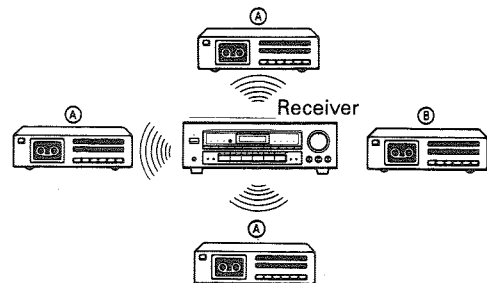

BASIC AUDIO SYSTEM CONNECTIONS

• Illustration shows U.S. model.

NOTE FOR FM ANTENNA:

Stretch the antenna out to its full length, and affix it to a wall, etc.

NOTE FOR AM LOOP ANTENNA:

The antenna should be placed at a distance from the receiver, and should not be allowed to touch metallic objects.

Avoid placing it near CD players, personal computers, television sets, and other devices generating radio frequencies.

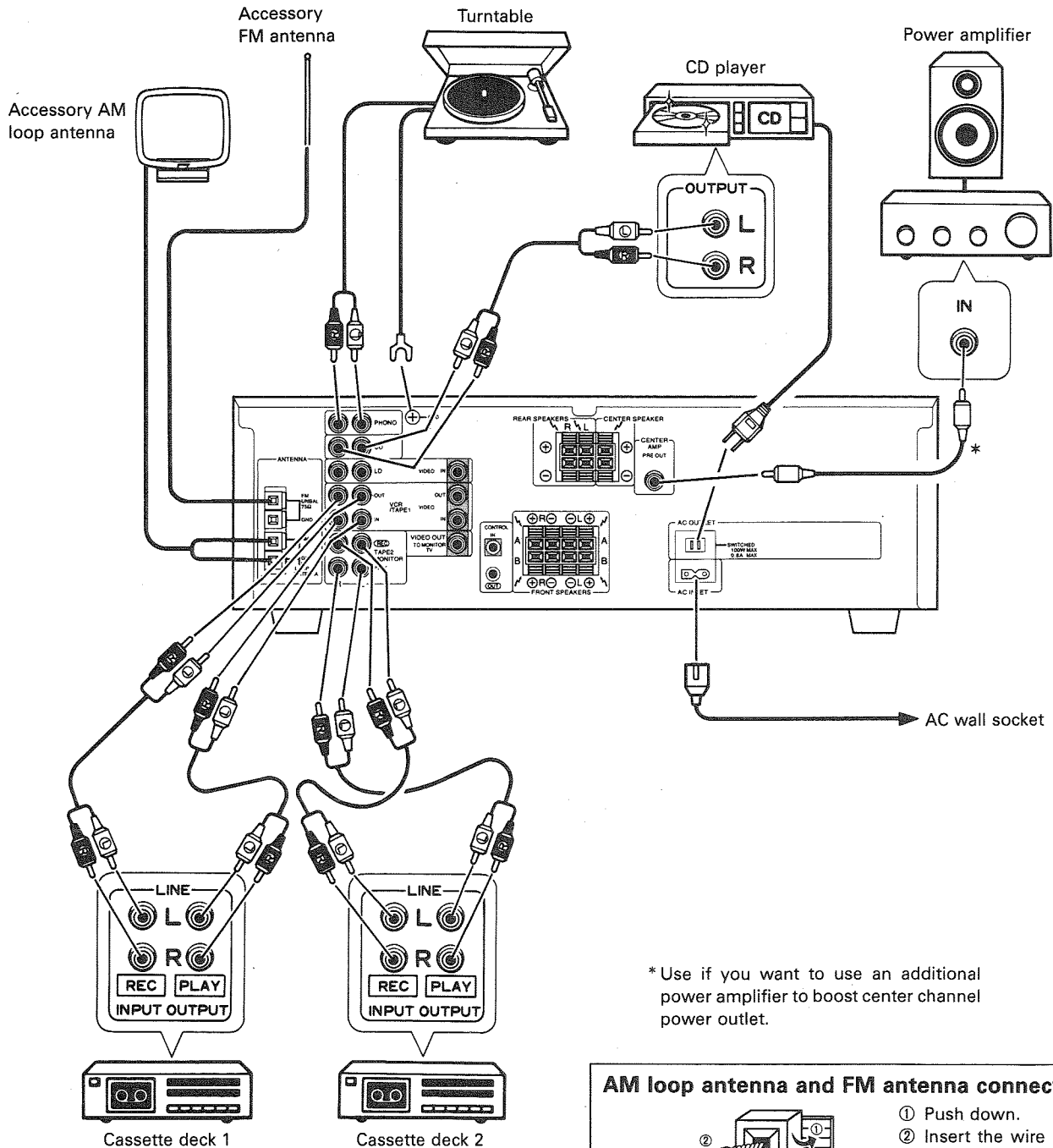

* Use if you want to use an additional power amplifier to boost center channel power outlet.

AM loop antenna and FM antenna connection

- ① Push down.
- ② Insert the wire into the hole.
- ③ Pull the lever back.

CONNECTIONS

BASIC VIDEO SYSTEM CONNECTIONS

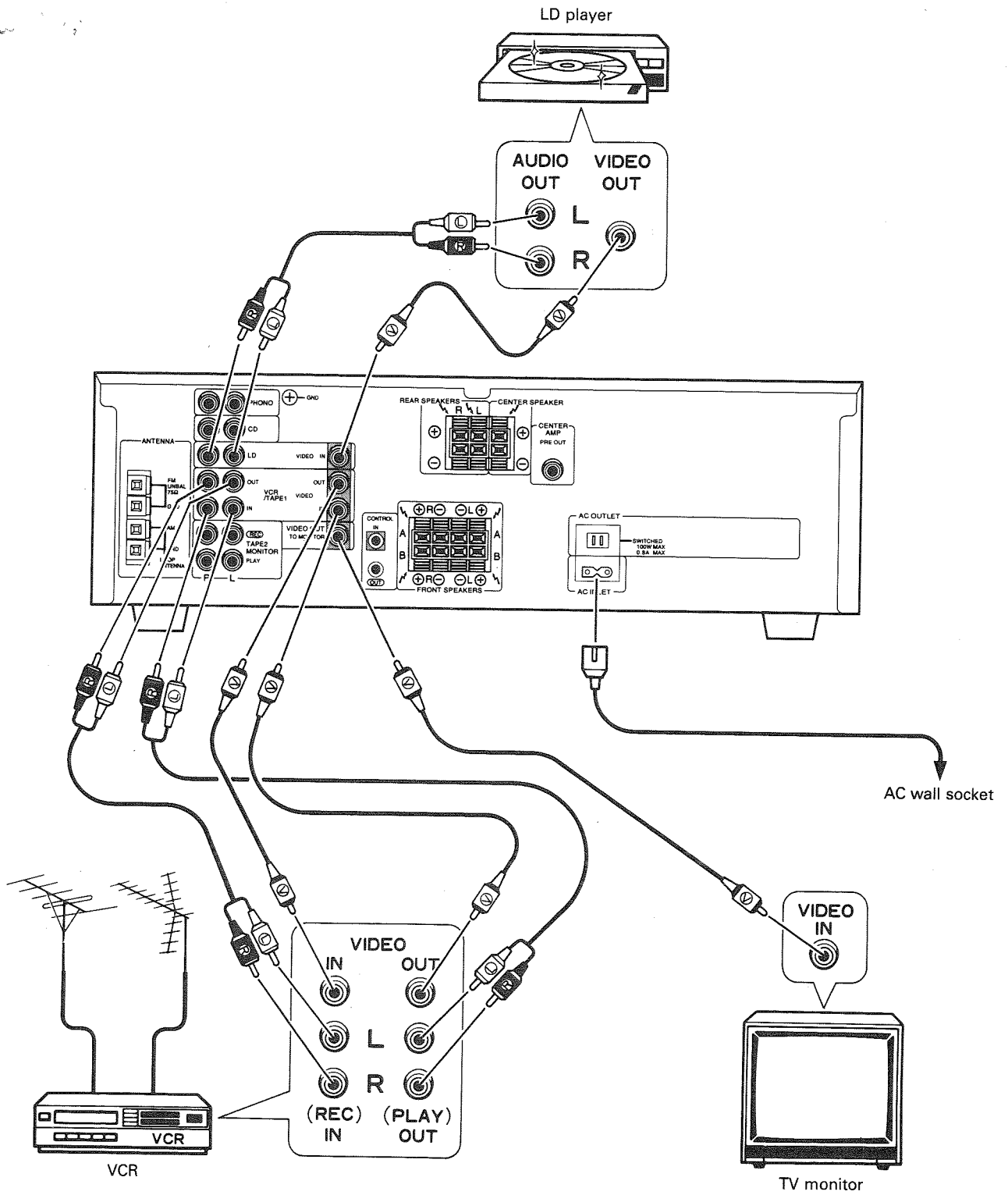

SPEAKER CONNECTIONS

Front/Rear speaker cord connection

- ① Push the lever up (or down).
- ② Insert the cord.
- ③ Pull the lever back.

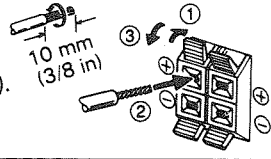

NOTE:

Use speakers with impedance of 8 Ω — 16 Ω.

Center speaker cord connection

- ① Push the lever down.
- ② Insert the cord.
- ③ Pull the lever back.

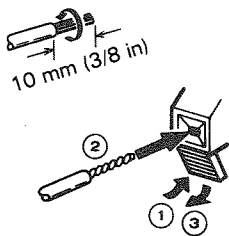

*** NOTE:**

Use if you want to use an additional power amplifier to boost center channel power output. Refer to page 5 for connection instructions.

NOTE:

When connecting a super woofer system such as the Pioneer S-W1000, connect it to the same speaker terminals (A or B) to which the front speakers are connected. Connecting the front speakers and super woofer system to terminals A and B respectively will result in reduced volume from the front speakers.

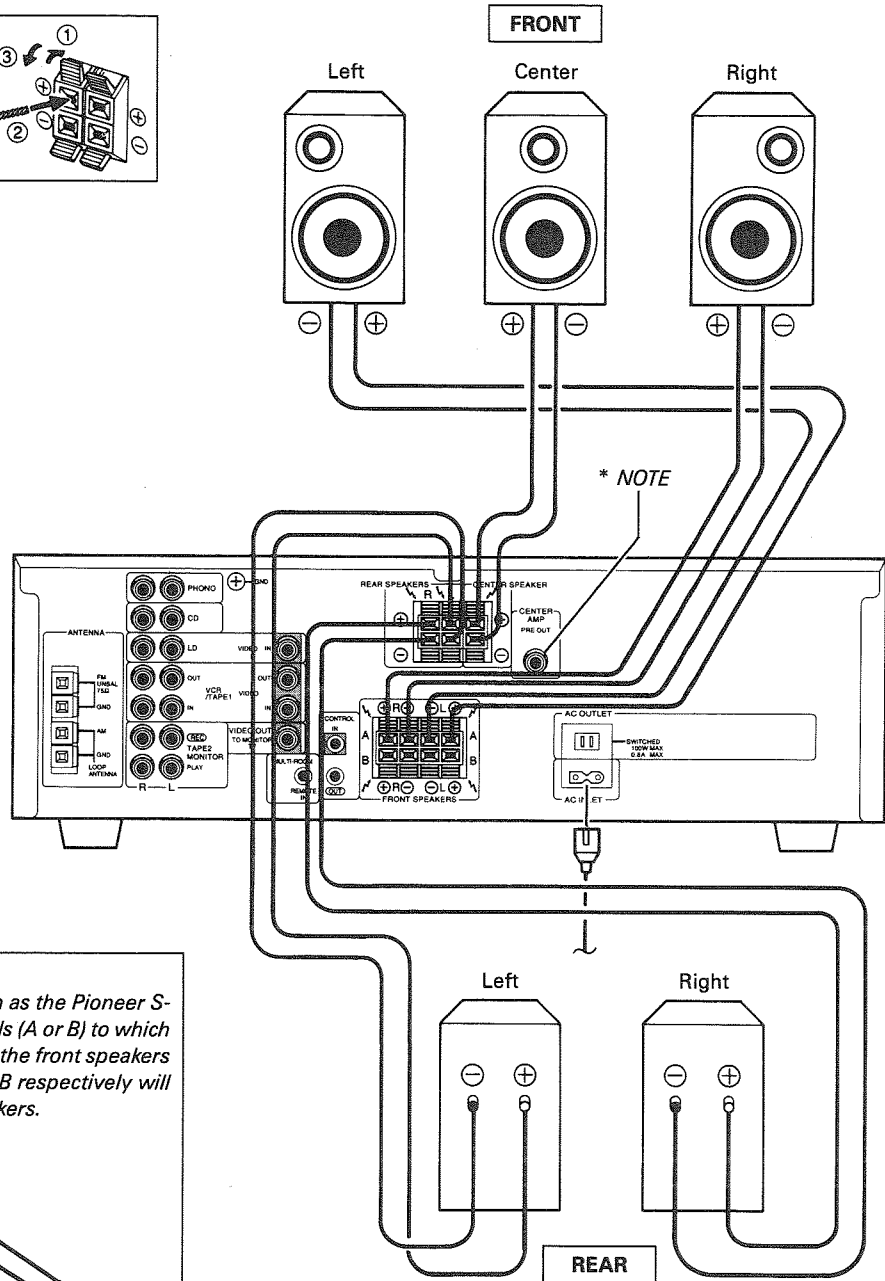
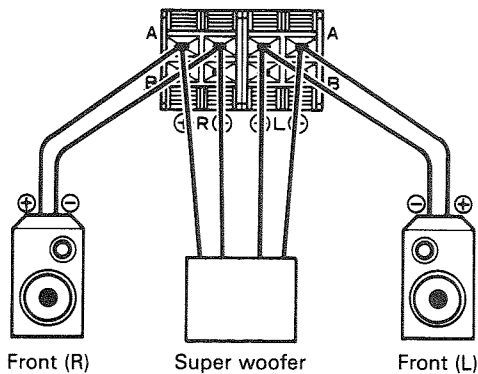

NOTE:

Do not allow any of the cord's conductors to protrude from the terminals or touch any other conductors. Malfunctioning or breakdowns may occur when conductors come into contact with each other.

FRONT PANEL FACILITIES

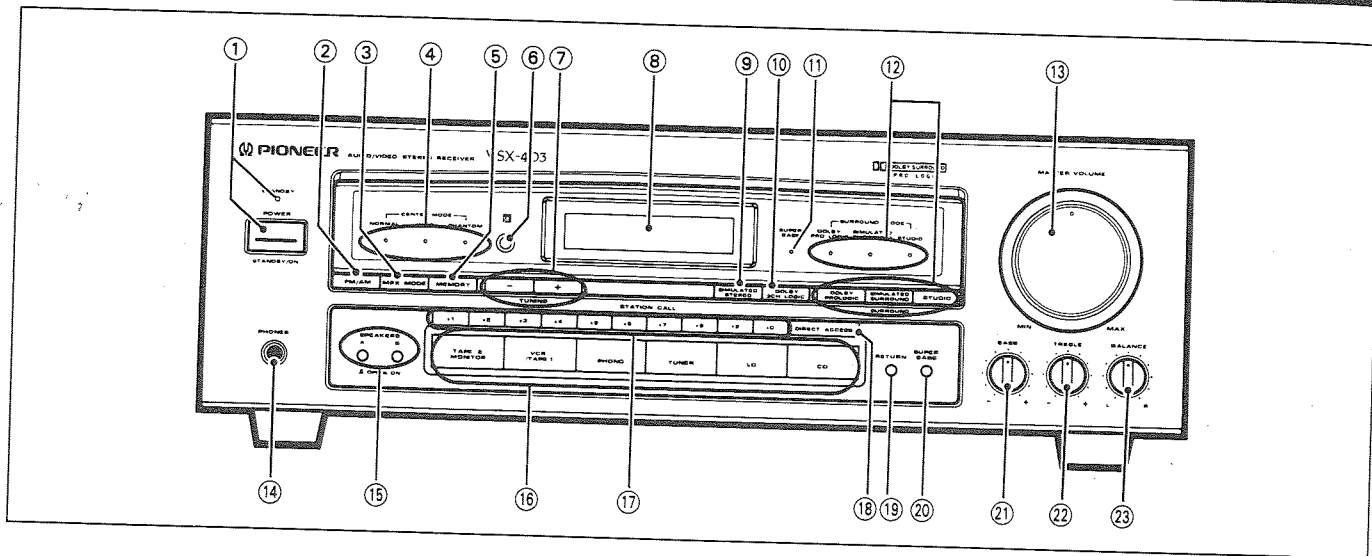

① POWER STANDBY/ON switch/STANDBY indicator

This is the switch for electric power.

ON : When set to the ON position, power is supplied and the unit becomes operational.

STANDBY : When set to STANDBY position, the main power flow is cut and the unit is no longer fully operational. A minute flow of power feeds the unit to maintain operation readiness. The STANDBY indicator lights when the power is STANDBY, and goes out during ON.

[Timer ON/OFF possible]

When the unit is switched ON, ON/OFF control can be performed by means of the optional timer.

NOTE:

When the power is initially turned ON, muting will be applied to prevent sound from being output for about 5 seconds.

② FM/AM button

Use this to switch between FM and AM frequency band reception.

③ MPX MODE button

Use to select the auto stereo mode or monaural mode when listening to FM broadcasts. The monaural mode has been selected when the FM MONO indicator in the display section is lit.

Auto stereo mode:

Normally, leave in this mode for reception. When a stereo FM broadcast is received, it will be automatically reproduced in stereo.

Monaural mode:

Use if the signal is weak and there is too much noise when receiving an FM stereo broadcast. Reception becomes monaural, but noise is reduced.

NOTE:

This button has no effect on reception of AM broadcasts.

④ CENTER MODE indicators (⇒ Page 15)

⑤ MEMORY button

Pressing this button will result in the memorization of the current broadcast band, reception frequency, and FM AUTO/MONO mode.

⑥ Remote sensor window

⑦ TUNING buttons (⇒ Pages 12, 13)

+: Performs tuning from the currently displayed station frequency in ascending frequency order.

-: Performs tuning in order of descending frequencies.

⑧ Display section (⇒ Page 9)

⑨ SIMULATED STEREO button

Press to produce a simulated stereo effect when listening to monaural sources (for example, AM or TV broadcasts). "SIMULATED STEREO" appears on the display section.

NOTE:

This effect is not produced through the rear speakers.

⑩ DOLBY 3CH LOGIC button

This switches on and off the DOLBY 3CH LOGIC.

⑪ SUPER BASS indicator

Lights when SUPER BASS is ON.

⑫ SURROUND MODE selector buttons/indicators

⑬ MASTER VOLUME control

Use it to simultaneously adjust the sound volume from the front, center, and rear speakers.

⑭ PHONES jack

Connect the plug on your headphones to this jack. Set all SPEAKERS A and B switches to OFF if you want to cut the sound from speakers and listen to it only through the headphones.

⑮ SPEAKERS buttons (A, B) ■ OFF ■ ON

ON/OFF switches for the A and B speaker systems.

NOTE:

No sound will be heard through the speakers when both A and B buttons are depressed if only one set of speakers has been connected to either A or B SPEAKERS terminals.

⑯ Input selector buttons

TAPE 2 MONITOR

: Press when performing playback on a second cassette deck and when monitoring recording.

VCR/TAPE 1 : Press when performing playback on a VCR unit or cassette deck.

PHONO : Press when playing records on a turntable.

TUNER : Press when listening to radio broadcasts.

LD : Press when performing playback on an LD player.

CD : Press when playing compact discs on a CD player.

17 STATION CALL buttons

Up to 30 FM or AM stations can be preset at random. These buttons are used to preset and recall desired broadcasting stations, FM AUTO/MONO mode.

18 DIRECT ACCESS tuning button (⇒ Page 11)

When this button is pressed, the STATION CALL buttons function as ten-key number buttons for direct input of the desired reception frequency. Press again to cancel this mode.

19 RETURN button

Press this button to return the receiver into the initial state. TUNER is selected at this initial state. Adjust the sound level by using the MASTER VOLUME control.

- TAPE 2 MONITOR Off
- SURROUND MODE Off
- MUTING Off
- FUNCTION TUNER

Returns you to the last FM station you were receiving. When reception is not possible, auto tuning (UP) starts from that frequency.

NOTE:

If no sound is output after the RETURN button is pressed, make sure that SPEAKERS buttons are turned on.

20 SUPER BASS button

Switch ON when you want to boost bass. The SUPER BASS indicator lights.

21 BASS control

Use to adjust the low-frequency level. Turn clockwise to boost bass, and counterclockwise to attenuate bass.

22 TREBLE control

Use to adjust the high-frequency level. Turn clockwise to boost treble, and counterclockwise to attenuate treble.

23 BALANCE control

Use to adjust the sound volume balance between left and right speakers.

L: Decrease the sound on the right side.

R: Decrease the sound on the left side.

Usually, left and right volume levels should be the same.

DISPLAY SECTION

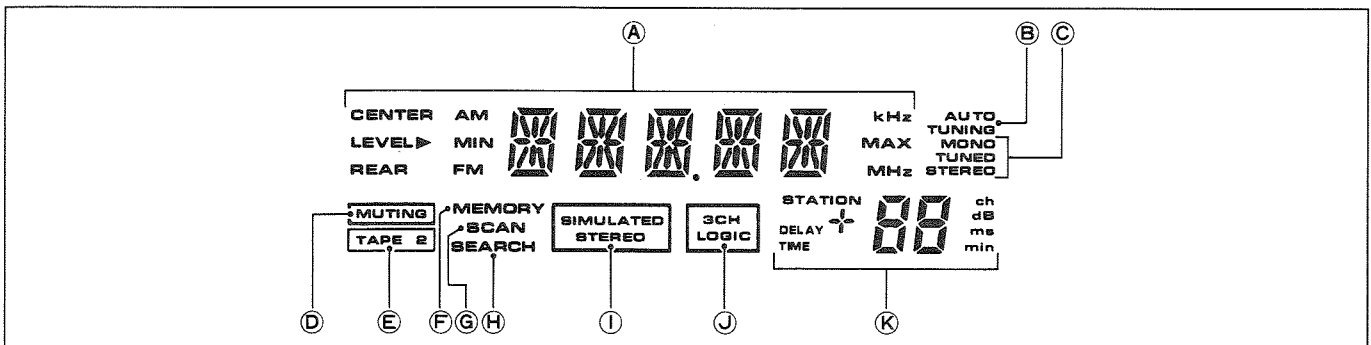

A Character/Level display

- Displays function, frequency, and "SLEEP".
- It also displays the level settings during adjustment. During level display, MIN and MAX light.

B AUTO TUNING indicator

Lights up when in the auto tuning mode.

C Tuning indicator

- TUNED** : Lights up when a station is tuned in during TUNER operation.
- MONO** : Lights up when the FM MONO mode is selected with the MPX MODE button.
- STEREO** : Lights up when a stereo FM broadcast is being received.

D MUTING indicator

Flashes when MUTING is ON.

E TAPE 2 indicator

Lights up when the input selector is set to TAPE 2 MONITOR ON.

F MEMORY indicator

When presetting stations, this lights when the MEMORY button is pressed.

G SCAN indicator

Lights up during memory scan operation.

H SEARCH indicator

Lights during Return mode operation.

I SIMULATED STEREO indicator

J DOLBY 3CH LOGIC indicator

K STATION/DELAY TIME/LEVEL/SLEEP TIME display

- Indicates the channel (ch) selected with the STATION CALL buttons.
- Indicates delay time (ms) when using SIMULATED SURROUND or DOLBY PRO LOGIC SURROUND.
- Indicates rear level and center level (dB).
- Indicates sleep timer settings (min).

REAR PANEL FACILITIES

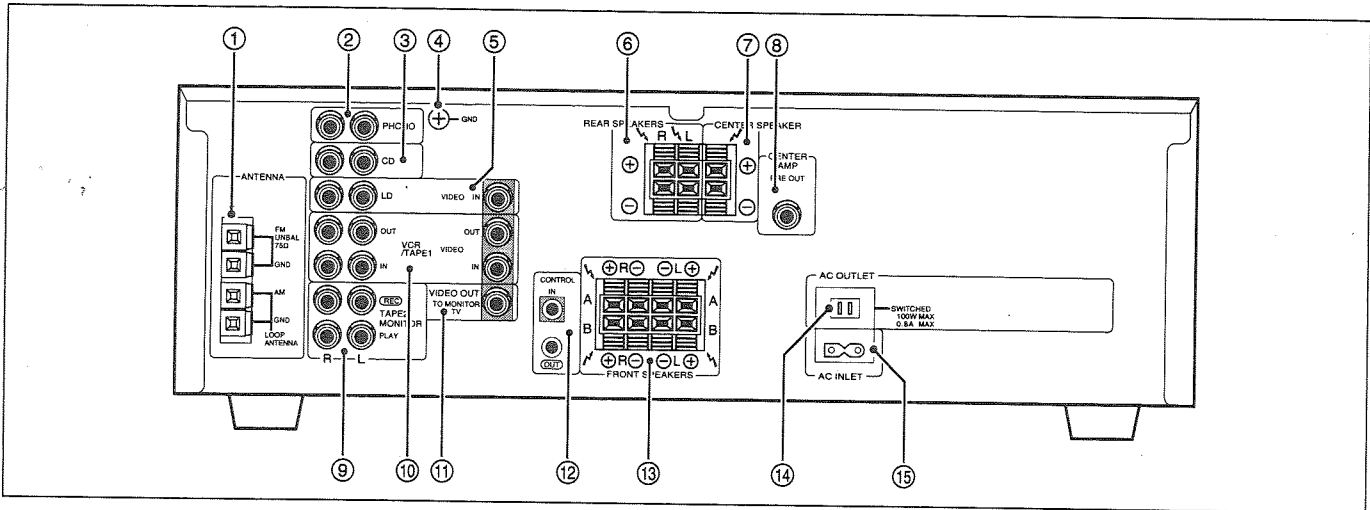

① FM/AM ANTENNA terminals (⇒ Page 5)

Connect to FM and AM antennas.

② PHONO input jacks (⇒ Page 5)

Connect to the output cables from a turntable.

③ CD input jacks (⇒ Page 5)

Connect to the output jacks of a compact disc player.

④ GND terminal (⇒ Page 5)

Connect the turntable ground lead to this terminal. Loosen the screw, connect the ground lead, and then tighten the screw.

⑤ LD input jacks (⇒ Page 6)

Connect to an LD player's output jacks (audio, video).

⑥ REAR SPEAKERS terminals (⇒ Page 6)

Connect the rear speakers to these terminals. Use rear speakers with impedance of 8 Ω to 16 Ω.

⑦ CENTER SPEAKER terminals (⇒ Page 7)

Connect the center speaker to these terminals. Use center speakers with impedance of 8 Ω to 16 Ω.

⑧ CENTER AMP PRE OUT jack (⇒ Page 5)

When a separate power amplifier is used to drive the surround center speaker, connect the power amplifier to this jack.

⑨ TAPE 2 MONITOR jacks (⇒ Page 5)

Connect to audio components such as a second cassette deck or graphic equalizer.

⑩ VCR/TAPE 1 jacks (⇒ Pages 6)

Connect to the first cassette deck or to a VCR. With a VCR, also connect the video jacks.

⑪ VIDEO OUT (TO MONITOR TV) jack (⇒ Page 6)

Connect to a monitor TV.

⑫ CONTROL IN/OUT jacks

IN : Connect this jack to other Pioneer components (main unit or remote control unit) when using those components to control this unit.

OUT : Connect this jack to other Pioneer components when using the remote control of this unit to control the other components.

NOTE:

The receiver's remote sensor does not function when a plug is inserted in the IN jack. To operate, point the remote control unit at the remote sensor on the component to which the receiver's IN jack is connected.

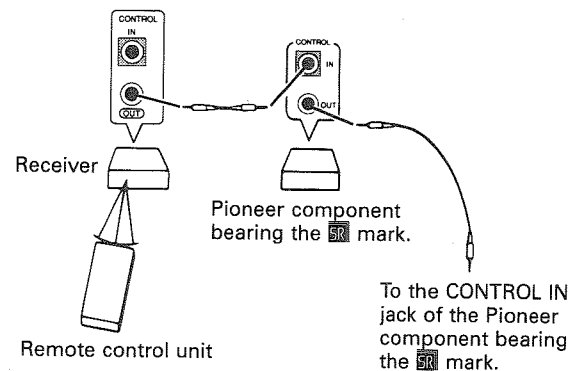

⑬ FRONT SPEAKERS terminals (⇒ Page 7)

A: Connect to the first set of speakers.

B: Connect to the second set of speakers.

Use speakers with impedance of 8 Ω—16 Ω.

⑭ AC OUTLET jack

[SWITCHED 100 W (0.8 A) MAX]

Power supplied through this outlet is turned on and off by the receiver's POWER switch. Electrical power consumption of the connected equipment should not exceed 100 W (0.8 A).

NOTE:

• This unit should be disconnected by removing the power plug from the wall socket when not in regular use, e.g. when on vacation.

• Do not connect appliances with high power consumption such as heaters, irons, or television sets to this AC OUTLET in order to avoid overheating and fire risk.

This can cause the receiver to malfunction.

CAUTION:
DO NOT CONNECT MONITOR OR TV SET.

⑮ AC INLET jack

Connect the supplied power cord here.

TUNER

Press the POWER switch to the ON position.
 Select TUNER with the input selector.
 Be sure to turn the TAPE 2 MONITOR button OFF when listening to AM or FM broadcasts.
 Switch ON the SPEAKERS button corresponding to the speakers being used.

FM auto stereo reception and monaural reception

Each time you press the MPX MODE button, the MONO indicator in the display section lights or goes out.

- If an FM stereo broadcast is received when the MONO indicator is out, the STEREO indicator lights, and sound is in stereo.
 - If an FM stereo broadcast is received when the MONO indicator is lit, the sound will be monaural.
- If there is interference during STEREO mode reception, switch to MONO. The sound will become monaural but interference will be reduced.

DIRECT ACCESS TUNING

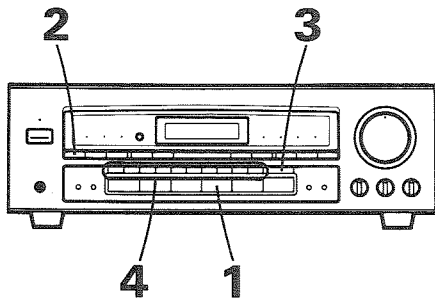

When you know the frequency of the desired station, the frequency can be input directly using the STATION CALL (number) buttons in the following way:

1. Select TUNER with the input selector buttons.
2. Select either FM or AM using the FM/AM button.
3. Press the DIRECT ACCESS button.
4. Input the desired station frequency using the STATION CALL buttons.

Example: To receive FM 106.00 MHz.

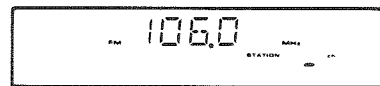
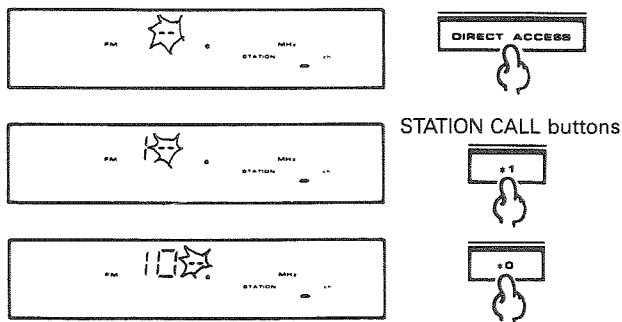

Once the station frequency has been input, the receiver tunes in that frequency. If the input frequency falls below the lower or higher limit of the receiver's receivable frequency range "LOWER" or "UPPER" is displayed, indicating that the frequency which has been input cannot be tuned in.

5. Adjust the sound volume and tone as desired.

To cancel frequency input

Direct access is canceled when the DIRECT ACCESS button is pressed again.

Under the following conditions direct access is canceled and the unit returns to the condition in effect before direct access was selected:

- ① If there is no key input for about five seconds after the DIRECT ACCESS button was pressed.
- ② If more than about five seconds elapse between number input.

AUTO TUNING

Auto tuning is convenient when you do not remember the frequency of a desired station, or when you wish to find stations that you do not normally listen to.

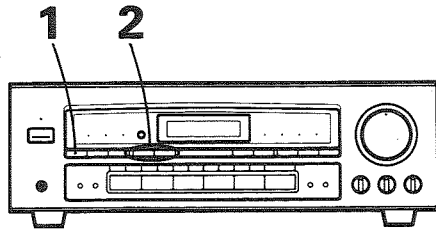

1. Select either FM or AM using the FM/AM button.
2. Press TUNING “-” or “+” button until the frequency starts to change, then release it.
 - The AUTO TUNING indicator lights, and the receiver automatically searches for a broadcasting station, and stops when one is found, at which time the TUNED indicator lights. Press again to search for another station.
 - To interrupt auto tuning, press TUNING button again.
3. Adjust the sound volume and tone as desired.

NOTE:

- When Auto Tuning is used, correct reception may not be possible for very distant stations or stations with very weak signals. In this event, Manual Tuning is recommended.
- The TUNED indicator may not light with broadcasts received over long distances, or when the broadcast signals are extremely weak.

MANUAL TUNING

Each time the TUNING button “+” or “-” is pressed, the tuning frequency changes by one step, allowing you to find stations manually.

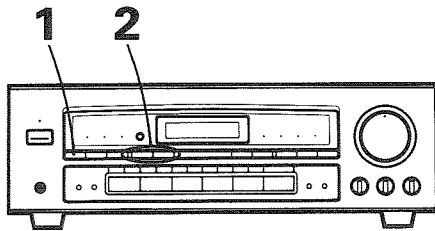

1. Use the FM/AM button to choose either FM or AM.
2. Press TUNING “-” or “+” button and release quickly.
 - The tuning frequency will change by one step each time the button is pressed. Press as many times as necessary to tune in the desired station. The TUNED indicator lights up when the station is tuned in best.
 - If you keep the TUNING button pressed after the AUTO TUNING indicator has gone out, the reception frequency changes continuously and stops when the button is released.
 - When a station is received, the TUNED indicator will light up.

NOTE:

- The TUNED indicator may not light with broadcasts received over long distances, or when the broadcast signals are extremely weak.
3. Adjust the volume and tone as desired.

PRESET TUNING

FREQUENCY PRESETTING

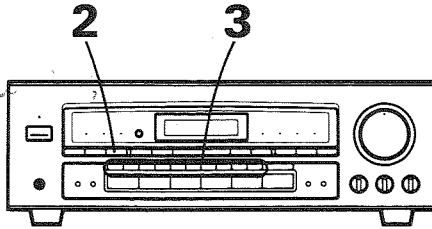

1. Tune in the desired station.

- See the section "DIRECT ACCESS TUNING" for information on reception using the Direct Access Tuning mode.
- See the section "AUTO TUNING" for information on reception using the Auto Tuning mode.
- See the section "MANUAL TUNING" for information on reception using the Manual Tuning mode.
In addition to station frequencies, the MPX MODE (AUTO/MONO) can also be preset (FM only).

2. Press the MEMORY button.

3. Press the STATION CALL button into which you wish to preset the station.

- Use the STATION CALL buttons (*1 — *9, *0) to select a preset channel. One press selects the 1 — 10 range, press twice 11 — 20, and press three times 21 — 30.

[Example] If you press button ***3** :

Once — 3 ch

Twice — 13 ch

Three times — 23 ch

Press a STATION CALL button within two seconds.

4. Repeat steps 1 to 3 to preset additional stations.

Total of 30 AM and FM stations may be preset. When you store a new preset, it takes the place of the previously stored station (if any).

LISTENING TO BROADCASTS USING PRESET TUNING

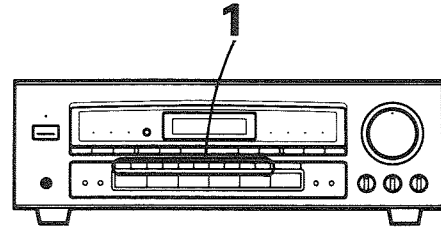

1. Press the STATION CALL button into which the desired station has been preset.

- When the input selector is set to a function other than TUNER, it will switch to the TUNER function automatically if one of the STATION CALL buttons is pressed.
Tuning can be performed simply and accurately following the above procedure.

2. Adjust the volume and tone as desired.

NOTE:

*The contents of the STATION CALL button will be retained for several days, even if the receiver power cord is unplugged.
If a preset station has been erased, preset it again.*

Last station memory

When the POWER switch is pressed to turn the power on, the last station received before the power was previously turned off will be tuned in again.

When the power is ON, if the FM/AM button is pressed, the last station received before the FM/AM button was previously pressed will be tuned in again.

MEMORY SCAN

Broadcast stations memorized under the STATION CALL buttons are recalled in order at about five second intervals.

Set the input selector to TUNER, and press the remote control's SCAN button.

When you are tuned into a broadcast station you want, press the SCAN button once more. This stops the memory scan.

RECEIVING FM SIMULCAST TV PROGRAMS

By combining a TV set and a VCR (or TV tuner), you can receive FM simulcast TV programs (stereo TV sound transmitted from an FM radio station) while viewing the video portion on your TV.

1. Select the desired TV program with the TV set.
2. Tune in the desired FM simulcast TV program on the receiver.
3. Adjust the volume and tone controls as desired.

OPERATING THE AUDIO/VIDEO COMPONENTS

Press the power switch to the ON position, and turn on the power to the other components you wish to use (for example, TV, VCR, cassette deck, etc.).

PLAYBACK

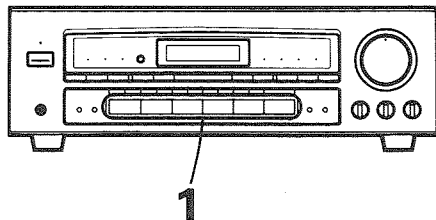

1. Use the input selector buttons to select the desired program source.

Program Source	Input selector
To listen to records	PHONO
To listen to compact discs	CD
To listen to a tape on the cassette deck connected to TAPE 2 MONITOR jacks	TAPE 2 MONITOR
To play back on a VCR connected to the VCR/TAPE 1 jack, or to play back on a cassette deck	VCR/TAPE 1
To watch a LaserDisc	LD

* If you select a music source other than TAPE 2, switch OFF the TAPE 2 MONITOR.

2. Operate the appropriate audio/video component to play back the program source.
 - For a video source, switch the TV connected to this unit to the video input mode.
3. Adjust the volume and tone controls as desired.
 - When listening to a monaural source, turn the SIMULATED STEREO button ON to enjoy simulated stereo sound.
 - Refer to page 15 for details concerning surround operation.

RECORDING WITH A CASSETTE DECK

RECORDING WITH VCR/TAPE 1

If the TAPE 2 MONITOR button is ON, press to turn OFF.

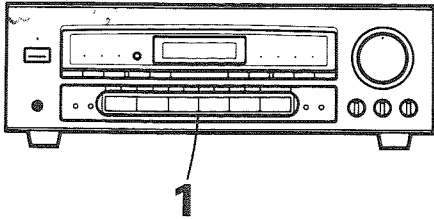

1. **Select the source you want to record from with the input selector buttons.**
 - When recording AM or FM broadcasts, press the desired STATION CALL button if the station has been preset. If the desired station has not been preset, tune in the station using Auto, Manual, or Direct Access tuning.
2. **Start recording on VCR/TAPE 1 cassette deck or VCR.**
3. **Play the desired program source (record, compact disc, etc.).**
 - The volume, balance, SUPER BASS, surround and tone controls have no effect on the recording.

RECORDING WITH TAPE 2

1. **Select the source you want to record from with the input selector buttons.**
 - Be sure the TAPE 2 MONITOR button is OFF.
2. **Start recording on the TAPE 2 cassette deck.**
3. **Play the desired program source (record, compact disc, etc.).**

When copying a tape, play back on the VCR/TAPE 1 cassette deck, and record on the TAPE 2 cassette deck.

Tape monitoring

When recording is performed on a cassette deck equipped with monitoring function, the recorded sound can be monitored through the speaker system by pressing the TAPE 2 MONITOR button to ON.

DOLBY PRO LOGIC SURROUND AND DOLBY 3CH LOGIC

Use with video or audio software bearing the  DOLBY SURROUND mark.

Use DOLBY PRO LOGIC SURROUND when rear speakers are connected, and DOLBY 3CH LOGIC when rear speakers aren't connected.

For correct surround reproduction, be sure to perform following adjustments.

SPEAKERS DOLBY 3CH LOGIC DOLBY PRO LOGIC

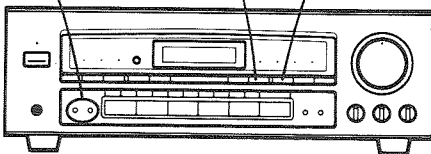

LEVEL ADJUSTMENT

1. Use SURROUND MODE buttons to select DOLBY PRO LOGIC SURROUND or use the DOLBY 3CH LOGIC button to switch DOLBY 3CH LOGIC ON.
2. Use SPEAKERS button to turn on front speakers.
3. Adjust MASTER VOLUME to a suitable listening level.
4. Set the BALANCE control to the center position.
5. Set the remote control AUDIO/VIDEO switch to AUDIO, and then select CENTER MODE with the CENTER MODE/TEST TONE button.
 - DOLBY PRO LOGIC SURROUND: NORMAL, WIDE, PHANTOM
 - DOLBY 3CH LOGIC: NORMAL, WIDE
6. Set the remote control AUDIO/VIDEO switch to VIDEO, and then switch the test tone on by pressing the CENTER MODE/TEST TONE button.

7. Use the remote control CENTER/REAR +, - buttons to adjust center and rear speaker volume levels until they are the same as the front speakers' volume level.
 - CENTER LEVEL ... Set the AUDIO/VIDEO switch to AUDIO.
 - REAR LEVEL ... Set the AUDIO/VIDEO switch to VIDEO.
8. After selecting VIDEO with the AUDIO/VIDEO switch, press the CENTER MODE/TEST TONE button and switch the test tone to off position.

OPERATION

1. Select DOLBY PRO LOGIC SURROUND with the SURROUND MODE buttons or select DOLBY 3CH LOGIC with the DOLBY 3CH LOGIC button.
2. Select the component for playback with the input selector buttons.
3. Set the remote control AUDIO/VIDEO switch to AUDIO, and then select CENTER MODE with the CENTER MODE/TEST TONE button.
4. Begin playback.
5. Adjust volume level with the MASTER VOLUME control.

SETTING THE DELAY TIME

When using DOLBY PRO LOGIC SURROUND, you can set the delay time between 15 ms and 30 ms. The standard setting is 20 ms, but you can select any setting of your choice.

Set the remote control AUDIO/VIDEO switch to VIDEO, and then select delay time with the SLEEP/DELAY TIME button. The selected delay time is indicated in the display section.

HINTS FOR BETTER RECEPTION

EXTERNAL FM ANTENNA

The main advantage of FM over AM is the quality of the broadcast signal. In order to benefit fully from the high signal quality of FM broadcasts, it is recommended that a special-purpose FM antenna be installed. In weak signal areas, a multi-element (3-element, 5-element, 7-element) antenna should be used.

GROUNDING

Grounding is recommended if reception of FM programs is impaired by noise. To ground, connect a thick polyvinyl insulated wire to the GND terminal and attach the other end to a metal water pipe or grounding bar or wind it around a copper plate and bury it.

NOTE:

Never connect a wire to a gas pipe for grounding since sparks may ignite the gas.

EXTERNAL AM ANTENNA

If it is not possible to obtain adequate AM reception even by changing the orientation of the AM loop antenna, a separate indoor antenna or an outdoor antenna should be installed.

INDOOR AM ANTENNA

Use a vinyl-insulated wire (5—6 m) and connect one end to the AM antenna terminal and affix the other end to the wall or ceiling, as high as possible.

OUTDOOR AM ANTENNA

If reception quality is not improved sufficiently even when an indoor antenna is used, a vinyl-insulated wire should be installed outside and fixed in place.

NOTE:

Do not detach the AM loop antenna when using an indoor or an outdoor AM antenna.

Connecting the 75 Ω coaxial cable

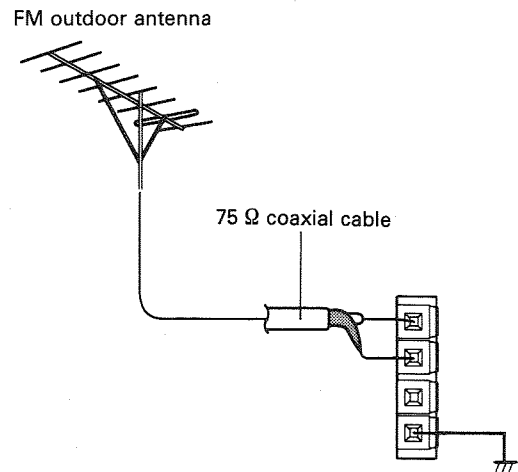

AM antenna connection

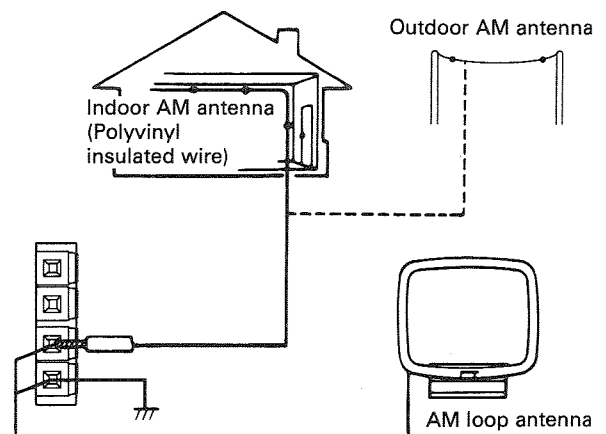

REMOTE CONTROL OPERATION

PUTTING BATTERIES INTO THE REMOTE CONTROL UNIT

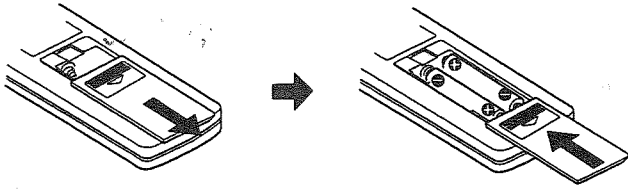

1. Open the battery compartment cover on the rear of the remote control unit. The cover should open easily if you slide it in the direction of the arrow while pressing on it with your thumb.
2. Take out the two supplied batteries size "AA" (R6/UM-3), and insert them into the battery compartment in accordance with the indications in the compartment.
3. Close the cover of the battery compartment.

Incorrect use of batteries may lead to leakage or rupture. Always be sure to follow these guidelines:

A.

Always insert batteries into the battery compartment correctly matching the positive (+) and negative (-) polarities, as indicated inside the compartment.

B.

Never mix new and used batteries.

C.

Batteries of the same size may have different voltages, depending on their type. Do not mix different types of batteries.

REMOTE CONTROL RANGE

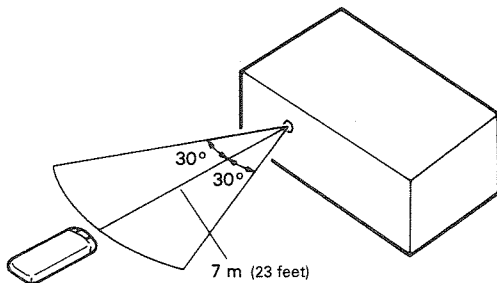

When operating the remote control unit, point the front of the unit at the front panel of the receiver. The remote control unit may be used within a range of about 7 meters (23 feet) from the remote sensor, within angles of up to about 30 degrees.

Performance of the remote control unit is adversely affected in the presence of strong fluorescent light. Keep such lights away, especially from the sensor window.

Battery Replacement

As battery power runs down, the range over which the remote control unit can operate decreases. When the range becomes too short, change the batteries.

- The accessory remote control unit can be used to control some functions of other Pioneer cassette decks, CD players, tuners, receiver, VCRs, LD players, and TVs (only those bearing the Pioneer mark **SR**).
- When the accessory remote control unit is used to operate other PIONEER components with the **SR** mark, it cannot be used to operate functions which do not correspond to the functions listed on the remote control unit.

Transmit mode selector switch

AUDIO:

Select this position for remote control operation of audio equipment such as a CD player or cassette deck.

VIDEO:

Select this position for remote control operation of video equipment such as an LD player, VCR or TV.

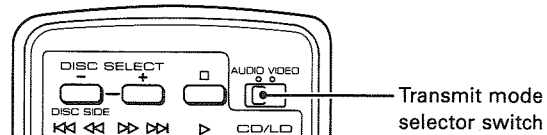

REMOTE CONTROL OPERATION

RECEIVER TUNER AND AMPLIFIER SECTION OPERATION

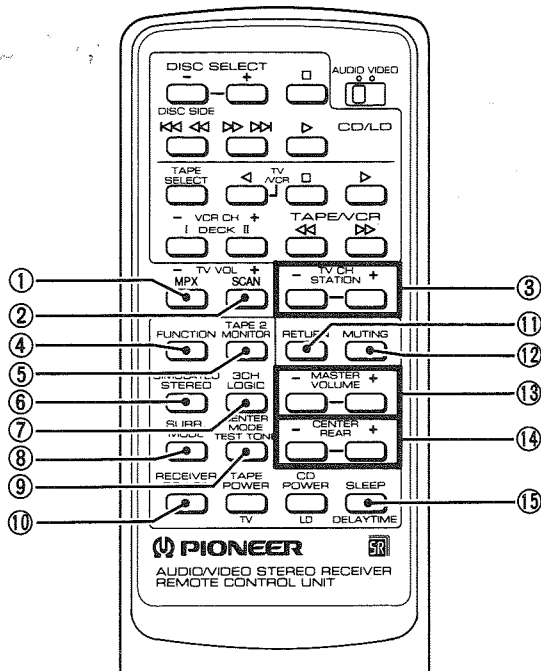

[TUNER SECTION OPERATION]

Set the AUDIO/VIDEO switch to AUDIO.

- ① **MPX button**
Switches between MONO/AUTO STEREO during FM reception.
- ② **SCAN button**
Use this to start memory scan of stations.
- ③ **STATION “-” (Down) “+” (Up) buttons**
Used for recalling memorized stations.

[AMPLIFIER SECTION OPERATION]

- ④ **FUNCTION button**
Press to select the receiver input.

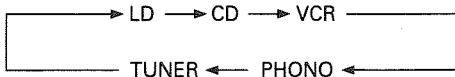

- ⑤ **TAPE 2 MONITOR button**
Switches TAPE 2 MONITOR ON/OFF.
- ⑥ **SIMULATED STEREO button**
Switches simulated stereo mode ON/OFF.
- ⑦ **3CH LOGIC button**
Switches DOLBY 3CH LOGIC ON/OFF.

⑧ **SURR. (Surround) MODE button**

The surround mode is switched in the following manner each time the button is pressed:

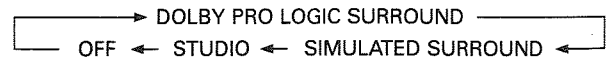

⑨ **CENTER MODE/TEST TONE button**

- **AUDIO/VIDEO switch ... AUDIO position**
Functions as a CENTER MODE button, enabling selection of the DOLBY PRO LOGIC SURROUND and DOLBY 3CH LOGIC center mode.
- **AUDIO/VIDEO switch ... VIDEO position**
Functions as a TEST TONE button for switching the test tone ON/OFF.

⑩ **RECEIVER POWER button**

Switches the receiver power ON/STANDBY.

⑪ **RETURN button**

Press to return the receiver to it's initial state. (Refer to page 9.)

⑫ **MUTING button**

Press to temporarily reduce sound. Press again to return to the original volume level.

⑬ **MASTER VOLUME (+, -) buttons**

Use to adjust the overall volume level.

⑭ **CENTER/REAR (+, -) buttons**

- **AUDIO/VIDEO switch ... AUDIO position**
Function as CENTER LEVEL adjustment buttons
- **AUDIO/VIDEO switch ... VIDEO position**
Function as REAR LEVEL adjustment buttons

⑮ **SLEEP/DELAY TIME button**

- **AUDIO/VIDEO switch ... AUDIO position**
Functions as a SLEEP button
Activates the SLEEP timer. The length changes in the following manner each time the button is pressed:

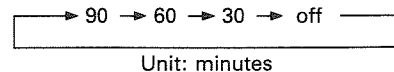

When SLEEP is ON, the display section is about half as bright as when SLEEP is OFF.

- **AUDIO/VIDEO switch ... VIDEO position**
Functions as a DELAY TIME button. You can change rear speaker delay time during DOLBY PRO LOGIC SURROUND or SIMULATED SURROUND operation.

CD PLAYER, CASSETTE DECK, TV, VCR, and LD PLAYER OPERATION

Operation of some of the functions of Pioneer components bearing the  mark is possible.

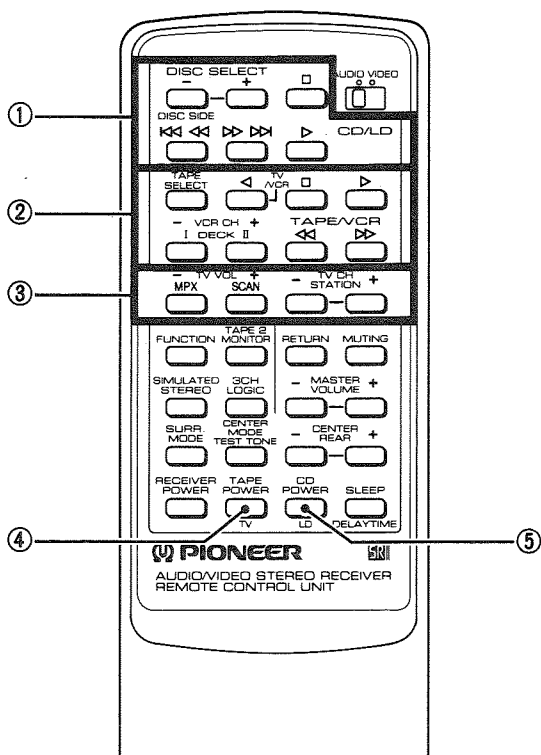

[CD PLAYER OPERATION]

Set the AUDIO/VIDEO switch to AUDIO.

① Operation buttons

- ⏮ (TRACK SEARCH) button:**
Returns to the beginning of the track currently in playing.
- ⏭ (TRACK SEARCH) button:**
Advances to the next track.
- ▶ (PLAY) button:**
Selects playback.

DISC SELECT (-, +) buttons:

Use to select a disc with a file-type CD player. Only the + button may be used to select the DISC No. (1 to 6) for a multi-play CD player, or used to select Twin CD DISC I/II.

NOTE:
Some multi-play CD players cannot be controlled using this button.

- **(STOP) button:**
Stops playback.

⑤ CD POWER button

Switches CD player power ON/OFF. This only applies to CD player which you can switch ON/OFF by remote control operation.

[CASSETTE DECK OPERATION]

Set the AUDIO/VIDEO switch to AUDIO.

② Operation buttons

TAPE SELECT button:

Selects the cassette No. (1 to 6) for a multi-cassette changer.

- ◀ **(PLAY) button:**
Selects reverse playback.
- **(STOP) button:**
Stops the tape transport.
- ▶ **(PLAY) button:**
Selects forward playback.

DECK I button:

Switches to the DECK I functions when using a double cassette deck.

For example, when operating the DECK I for playback, press this button before pressing ▶ button or ◀ button.

DECK II button:

Switches to the DECK II functions when using a double cassette deck.

For example, when operating the DECK II for playback, press this button before pressing ▶ button or ◀ button.

- ◀◀ **(FF) button:**
Rapidly advances the tape in the direction of the arrow.
- ▶▶ **(FF) button:**
Rapidly advances the tape in the direction of the arrow.

NOTE:

- Some cassette decks cannot be controlled using TAPE SELECT button.
- The ◀ button can only be used with cassette decks capable of reverse play.
- Some buttons will not work with all types of cassette decks. Refer to the operating instructions for more information.
- When operating the tape deck, be sure to use the DECK I or DECK II button to choose the desired deck before using the other operating buttons.
- When using a single deck, press the DECK II button before using the other operating buttons.

④ TAPE POWER button

Switches cassette deck power ON/OFF. This only applies to cassette deck which you can switch ON/OFF by remote control operation.

[TV OPERATION]

Set the AUDIO/VIDEO switch to VIDEO.

③ Operation buttons

TV VOL (volume) (+, -) buttons:

Raises (+) and lowers (-) the volume.

TV CH (channel) (+, -) buttons:

Switches TV channels in order.

④ TV POWER button

Switches the power of the TV ON/OFF.

REMOTE CONTROL OPERATION

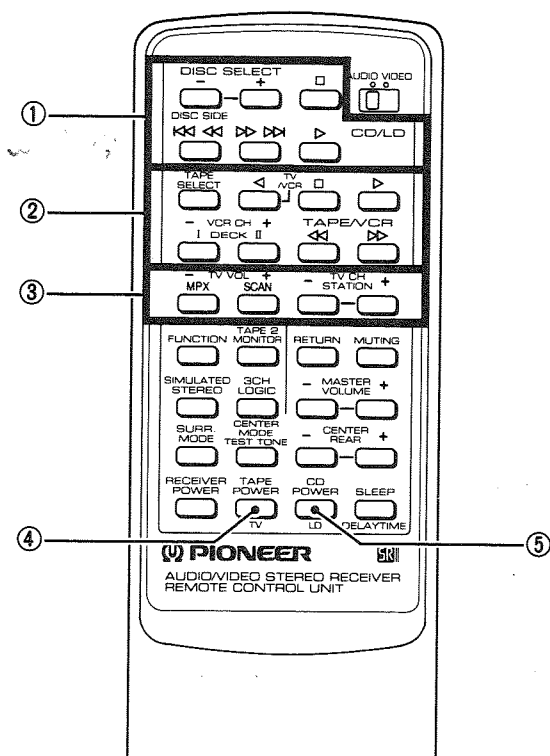

[VCR OPERATION]

Set the AUDIO/VIDEO switch to VIDEO.

② Operation buttons

TV/VCR button:

This button can be used only for VCRs with a TV/VCR selector. Toggles the antenna output between VCR and TV.

■ (STOP) button:

Stops tape transport.

▶ (PLAY) button:

Selects playback.

VCR CH - (DOWN) button:

Shifts VCR's TV tuner channels in descending order.

VCR CH + (UP) button:

Shifts VCR's TV tuner channels in ascending order.

◀ (REW) button:

Rewinds the tape and allows picture search.

▶▶ (FF) button:

Rapidly advances the tape and allows picture search.

[LD PLAYER OPERATION]

Set the AUDIO/VIDEO switch to VIDEO.

① Operation buttons

DISC SIDE button:

Changes the disc side in an LD player capable of playing both sides of a disc.

◀ (SCAN) button:

Selects fast backward.

▶▶ (SCAN) button:

Selects fast forward.

▶ (PLAY) button:

Selects playback.

■ (STOP/EJECT) button:

Playback is stopped when pressed once. Pressing again causes the disc table to come out.

⑤ LD POWER button

Switches LD player power ON/OFF.

This only applies to LD player which you can switch ON/OFF by remote control operation.

TROUBLESHOOTING

Incorrect operations are often mistaken for trouble and malfunctions. If you think that there is something wrong with this component, check the points below. Sometimes the trouble may lie in another component. Investigate the other components and electrical appliances being used. If the trouble cannot be rectified even after exercising the checks listed below, ask your nearest PIONEER authorized service center or your dealer to carry out repair work.

Symptom	Cause	Remedy
Power does not come on even when POWER switch is pressed.	<ul style="list-style-type: none"> • Power cord is disconnected. • Instances are rare, but the problem may be due to the operation of the protector circuit. 	<ul style="list-style-type: none"> • Connect cord securely. • Unplug the power cord of the unit from the AC wall outlet, then plug it in again.
Control was not possible regardless of what operation button was pressed.	<ul style="list-style-type: none"> • Static electricity affected the unit when the air was dry, such as in winter. 	<ul style="list-style-type: none"> • Unplug the power cord of the unit from the AC wall outlet, then plug it in again. • If static electricity is pronounced, it is recommended that you operate the unit using the remote control unit.
No sound or picture are produced, even when the input selector button is selected.	<ul style="list-style-type: none"> • Connections are incorrect. 	<ul style="list-style-type: none"> • Consult pages 4 — 7 and perform connections correctly.
	<ul style="list-style-type: none"> • The MUTING button is pressed. 	<ul style="list-style-type: none"> • Press the MUTING button to cancel the MUTING effect.
	<ul style="list-style-type: none"> • VOLUME is turned down. 	<ul style="list-style-type: none"> • Raise volume.
	<ul style="list-style-type: none"> • Speaker connecting wires are disconnected from speaker terminals. 	<ul style="list-style-type: none"> • Connect wires to terminals securely.
	<ul style="list-style-type: none"> • One or both of the input cords are disconnected. 	<ul style="list-style-type: none"> • Connect input cords securely.
	<ul style="list-style-type: none"> • TAPE 2 MONITOR button is in the ON position. 	<ul style="list-style-type: none"> • Press the button again to the OFF position.
High noise level.	<ul style="list-style-type: none"> • The SPEAKERS button is OFF. 	<ul style="list-style-type: none"> • Switch the SPEAKERS button ON.
	<ul style="list-style-type: none"> • Station has not been tuned in to correct frequency. 	<ul style="list-style-type: none"> • Tune the station in correctly.
	<ul style="list-style-type: none"> • Antenna has not been connected or has become disconnected. 	<ul style="list-style-type: none"> • Connect the antenna securely.
	FM reception <ul style="list-style-type: none"> • Accessory FM antenna remains bundled up or it is not pointing in right direction. 	<ul style="list-style-type: none"> • Stretch the antenna taut and locate direction yielding optimum reception.
	<ul style="list-style-type: none"> • Weak broadcasting station signals. 	<ul style="list-style-type: none"> • Replace accessory FM antenna with outdoor FM antenna.
	AM reception <ul style="list-style-type: none"> • AM loop antenna is not pointing in right direction. 	<ul style="list-style-type: none"> • Change the direction of AM loop antenna and find a position where reception is improved.
	<ul style="list-style-type: none"> • Weak broadcasting station signals. 	<ul style="list-style-type: none"> • Erect outdoor AM antenna or connect ground wire.
<ul style="list-style-type: none"> • Noise being picked up from this unit and other equipment (especially electrical appliances using motors or fluorescent lights). 	<ul style="list-style-type: none"> • Stop using appliances generating noise or remove them from vicinity of the stereo equipment. • Separate the loop antenna from the unit by some distance. 	

TROUBLESHOOTING

Symptom	Cause	Remedy
When in Auto tuning, it does not stop automatically.	<ul style="list-style-type: none"> Input signals are not strong enough. 	<ul style="list-style-type: none"> (FM) If the supplied simple antenna is being used, change to an outdoor antenna.
TV source cannot be seen when the VCR's TV tuner is used.	<ul style="list-style-type: none"> TV antenna is not connected to VCR, or connections are faulty. 	<ul style="list-style-type: none"> Consult the VCR's operating instructions, and connect antenna correctly.
	<ul style="list-style-type: none"> You are attempting to watch a TV source using a VCR with copy system connections. In general, when copy system connections are made, the VCR's TV tuner function ceases to operate. For details, consult the operating instructions for your VCR. 	<ul style="list-style-type: none"> Disconnect the copy system connection (TV tuner function will operate).
No rear sound is produced.	<ul style="list-style-type: none"> The SURROUND MODE selector button is set incorrectly. The REAR LEVEL is turned down. Speaker connecting wires are disconnected from REAR SPEAKERS terminals. 	<ul style="list-style-type: none"> Set correctly. Adjust the rear level with the remote control unit's REAR LEVEL buttons. Connect wires to terminals securely.
Remote control does not work.	<ul style="list-style-type: none"> Batteries are dead or no batteries in remote control unit. Poor angle or too great a distance from the remote sensor window. There is an obstacle between you and the remote sensor window. A fluorescent light is shining on the remote sensor window. 	<ul style="list-style-type: none"> Insert new batteries. Use within 7 meters (23 feet) and within a 30 degree angle of the remote sensor window. Change your position or move the obstacle. Move so fluorescent light does not shine directly on amplifier front panel remote sensor window.

Abnormal functioning of this unit may be caused by lightning, static electricity, or other external interference. To restore normal operation, turn the power off and then on again, or unplug the AC power cord and then plug it in again.

POWER-CORD CAUTION

Handle the power cord by the plug. Do not pull out the plug by tugging the cord and never touch the power cord when your hands are wet as this could cause a short circuit or electric shock. Do not place the unit, a piece of furniture, etc., on the power cord, or pinch the cord. Never make a knot in the cord or tie it with other cords. The power cords should be routed such that they are not likely to be stepped on. A damaged power cord can cause fire or give you an electrical shock. Check the power cord once in a while. When you find it damaged, ask your nearest PIONEER authorized service center or your dealer for a replacement.

SPECIFICATIONS

Amplifier section

Continuous average power output of 65 watts* per channel, min., at 8 ohms, from 20 Hz to 20,000 Hz with no more than 0.09% total harmonic distortion (front).**

Continuous Power Output (in Stereo Mode)

Front 65 W + 65 W (20 Hz to 20 kHz, 0.09 %, 8 Ω)

Continuous Power Output (When using SURROUND MODE)

Rear only driven 20 W + 20 W (1 kHz, 0.8 %, 8 Ω)

Front and Center driven

Front 45 W + 45 W (1 kHz, 0.8 %, 8 Ω)

Center (Only with DOLBY PRO LOGIC SURROUND) 45 W

(1 kHz, 0.8 %, 8 Ω)

Dynamic Power (2 Ω / 4 Ω /8 Ω) 165 W/110 W/100 W

Input (Sensitivity/Impedance)

PHONO MM 2.8 mV/47 k Ω

CD, VCR/TAPE 1, TAPE 2, LD 200 mV/47 k Ω

Phono Overload Level (T.H.D. 0.1 %, 1 kHz)**

PHONO MM 100 mV

Frequency Response

PHONO MM 20 Hz to 20,000 Hz ± 0.5 dB

CD, VCR/TAPE 1, TAPE 2, LD 10 Hz to 100,000 Hz ± 0.5 dB

Output (Level/Impedance)

VCR/TAPE 1 REC, TAPE 2 REC 200 mV/2.2 k Ω

Tone Control

BASS ± 8 dB (100 Hz)

TREBLE ± 8 dB (10 kHz)

Signal-to-Noise Ratio (IHF, short circuited, A network)

PHONO MM 72 dB

CD, VCR/TAPE 1, TAPE 2, LD 96 dB

Signal-to-Noise Ratio (EIA, at 1 W 1kHz)

PHONO MM 75dB

CD, VCR/TAPE 1, TAPE 2, LD 79 dB

* Measured pursuant to the Federal Trade Commission's Trade Regulation rule on Power Output Claims for Amplifier.

** Measured by Audio Spectrum Analyzer.

VIDEO Section

Input (Sensitivity/Impedance)

VCR/TAPE 1, LD 1 Vp-p/75 Ω

Output (Level/Impedance)

VCR/TAPE 1, MONITOR 1 Vp-p/75 Ω

Frequency Response

VCR/TAPE 1, LD \rightarrow MONITOR 5 Hz to 10 MHz ± 0.5 dB

Signal-to-Noise Ratio 55 dB

Cross Talk 55 dB

FM Tuner Section

Frequency Range 87.5 MHz to 108 MHz

Usable Sensitivity Mono: 11.2 dBf, IHF (1.0 μ V/75 Ω)

50 dB Quieting Sensitivity Mono: 16.8 dBf

Stereo: 38.6 dBf

Signal-to-Noise Ratio Mono: 73 dB (at 85 dBf)

Stereo: 70 dB (at 85 dBf)

Distortion Stereo: 0.5 % (1 kHz)

Alternate Channel Selectivity 60 dB (400 kHz)

Stereo Separation 40 dB (1 kHz)

Frequency Response 30 Hz to 15 kHz ± 1 dB

Antenna Input 75 Ω unbalanced

AM Tuner Section

Frequency Range 530 kHz to 1,700 kHz

Sensitivity (IHF, Loop antenna) 350 μ V/m

Selectivity 25 dB

Signal-to-Noise Ratio 50 dB

Antenna Loop antenna

Miscellaneous

Power requirements AC 120 V, 60 Hz

Power consumption 200 W, 290 VA

Dimensions 420 (W) x 140 (H) x 349 (D) mm

16-9/16 (W) x 5-1/2 (H) x 13-3/4 (D) in

Weight (without package) 7.5 kg (16 lb 9 oz)

Furnished Parts

FM Antenna 1

AM Loop Antenna 1

Dry Cell Batteries

size "AA" (IEC R6/UM-3) 2

Remote Control Unit 1

Operating Instructions 1

Power Cord 1

NOTE:

Specifications and the design are subject to possible modifications without notice due to improvements.

MAINTENANCE OF EXTERNAL SURFACES

- Use a polishing cloth or dry cloth to wipe off dust and dirt.
- When the surfaces are very dirty, wipe with a soft cloth dipped in some neutral cleanser diluted five or six times with water, and wrung out well, and then wipe again with a dry cloth. Do not use furniture wax or cleaners.
- Never use thinners, benzene, insecticide sprays and other chemicals on or near this unit, since these will corrode the surfaces.



Dear Customer:

Selecting fine audio equipment such as the unit you've just purchased is only the start of your musical enjoyment. Now it's time to consider how you can maximize the fun and excitement your equipment offers. This manufacturer and the Electronic Industries Association's Consumer Electronics Group want you to get the most out of your equipment by playing it at a safe level. One that lets the sound come through loud and clear without annoying blaring or distortion—and, most importantly, without affecting your sensitive hearing.

Sound can be deceiving. Over time your hearing "comfort level" adapts to higher volumes of sound. So what sounds "normal" can actually be loud and harmful to your hearing. Guard against this by setting your equipment at a safe level **BEFORE** your hearing adapts.

To establish a safe level:

- Start your volume control at a low setting.
- Slowly increase the sound until you can hear it comfortably and clearly, and without distortion.

Once you have established a comfortable sound level:

- Set the dial and leave it there.

Taking a minute to do this now will help to prevent hearing damage or loss in the future. After all, we want you listening for a lifetime.

We Want You Listening For A Lifetime

Used wisely, your new sound equipment will provide a lifetime of fun and enjoyment. Since hearing damage from loud noise is often undetectable until it is too late, this manufacturer and the Electronic Industries Association's Consumer Electronics Group recommend you avoid prolonged exposure to excessive noise. This list of sound levels is included for your protection.

Decibel

<u>Level</u>	<u>Example</u>
30	Quiet library, soft whispers
40	Living room, refrigerator, bedroom away from traffic
50	Light traffic, normal conversation, quiet office
60	Air conditioner at 20 feet, sewing machine
70	Vacuum cleaner, hair dryer, noisy restaurant
80	Average city traffic, garbage disposals, alarm clock at two feet.

THE FOLLOWING NOISES CAN BE DANGEROUS UNDER CONSTANT EXPOSURE

90	Subway, motorcycle, truck traffic, lawn mower
100	Garbage truck, chain saw, pneumatic drill
120	Rock band concert in front of speakers, thunderclap
140	Gunshot blast, jet plane
180	Rocket launching pad

Information courtesy of the Deafness Research Foundation.



Published by Pioneer Electronic Corporation.
Copyright © 1994 Pioneer Electronic Corporation.
All rights reserved.

PIONEER ELECTRONIC CORPORATION 4-1, Meguro 1-Chome, Meguro-ku, Tokyo 153, Japan
PIONEER ELECTRONICS [USA] INC. 2265 East 220th Street, Long Beach, California 90810, U.S.A.
 P.O. BOX 1720, Long Beach, California 90801, U.S.A.
PIONEER ELECTRONICS OF CANADA, INC. 300 Allstate Parkway Markham, Ontario L3R 0P2, Canada
PIONEER ELECTRONIC [EUROPE] N.V. Haven 1087 Keetberglaan 1, 9120 Melsele, Belgium, TEL: 03/750.05.11
PIONEER ELECTRONICS AUSTRALIA PTY. LTD. 178-184 Boundary Road, Braeside, Victoria 3195, Australia, TEL: [03] 580-9911