

TU-717

OPERATING INSTRUCTIONS

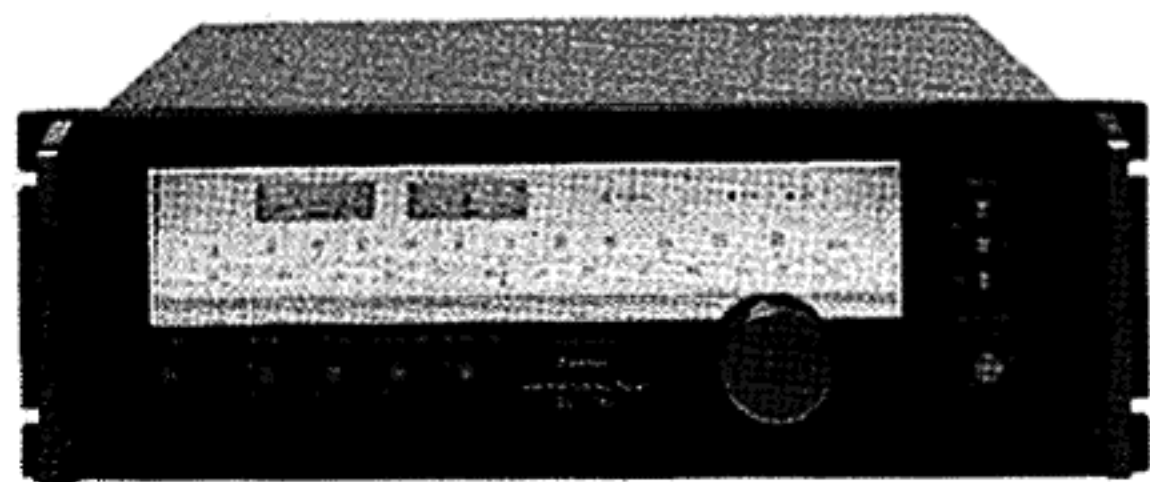

• Read this manual before use.

Sansui

For the United Kingdom only

Important

The wires in this mains lead are coloured in accordance with the following code:

Blue: Neutral

Brown: Live

If the colours of the wires in the mains lead of this equipment should not correspond to the coloured markings identifying the terminals in your plug, proceed as follows:

The wire which is coloured blue must be connected to the terminal which is marked with the letter 'N' or coloured black.

The wire which is coloured brown must be connected to the terminal which is marked with the letter 'L' or coloured red.

Ensure that your equipment is connected correctly. If you are in any doubt, consult a qualified electrician.

For equipment purchased outside the U.K. with a "EUROPEAN" two-pin mains plug, the plug should be removed and connections made in accordance with the above instructions. Ensure also that the equipment is properly adjusted to 240 volts operation. If you are in any doubt, consult a qualified electrician, or our Service Agent in the U.K.

We are grateful for your choice of the Sansui TU-717 AM/FM stereo tuner.

Before you begin operating your TU-717, we suggest that you read this booklet of operating instructions once carefully. You will then be able to connect and operate it correctly, and enjoy its superb performance for years.

Table of contents

Precautions	4
Connections	6
Panel information	12
Operating procedures	18
Some useful hints	20
About rack mounting adaptors	28
Specifications	30

WARNING: To prevent fire or shock hazard, do not expose this appliance to rain or moisture.

- **Do not lose the Warranty Card that carries your unit's Model No. and Serial No.**

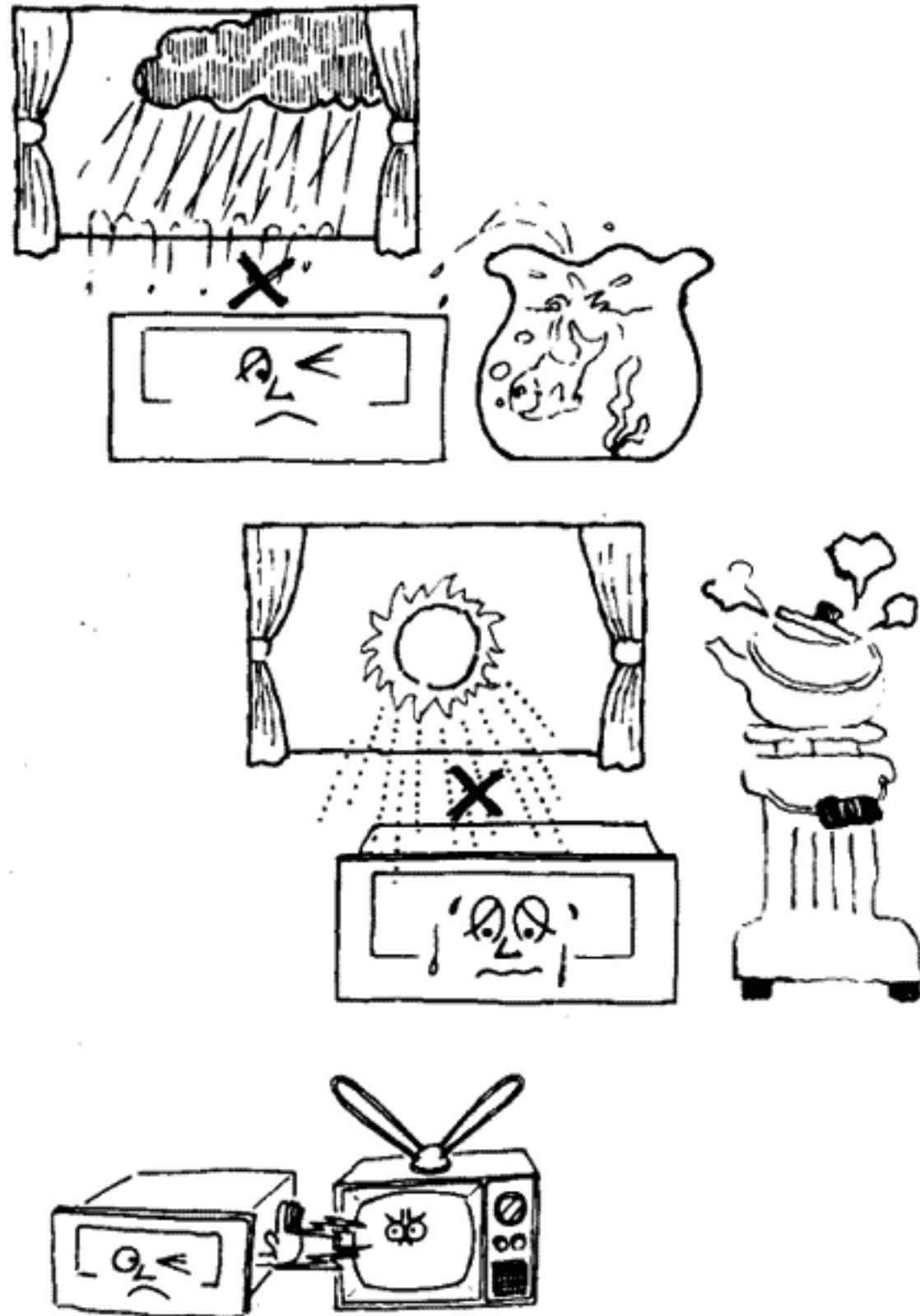

Precautions

- * Don't remove the cabinet cover or bottom board of the unit.

Installation

- * Never install the unit in dusty or humid locations, or in close proximity to heating appliances. Also, do not place it near a flower basin or fish bowl, for accidental spillover may cause fire, electrical shock and/or breakdown.
- * Keep the unit away from TV sets to avoid buzz noise.
- * When mounting the unit on a shelf, be sure that its supports are solidly fixed.

Connection

- * When connecting or re-locating the unit, be sure to turn the power off or disconnect the power cable.
- * Be sure not to confuse the right channel with the left, plus cables with minus or inputs with outputs. Check each step carefully.
- * Use connection cords of dependable quality. Check that connections are secure and that leads of connection are not frayed or in contact with other objects. Poor connection may cause hum noise or breakdown.

Don't use thinner on equipment

Use soft, dry cloth to wipe the front panel or the cabinetry of this unit. Never use thinner, alcohol or other solvents, or some of the words indicated on the front panel may be erased or the dial plate may become foggy. Also, when you use aerosol insecticide, be sure to avoid spraying the unit.

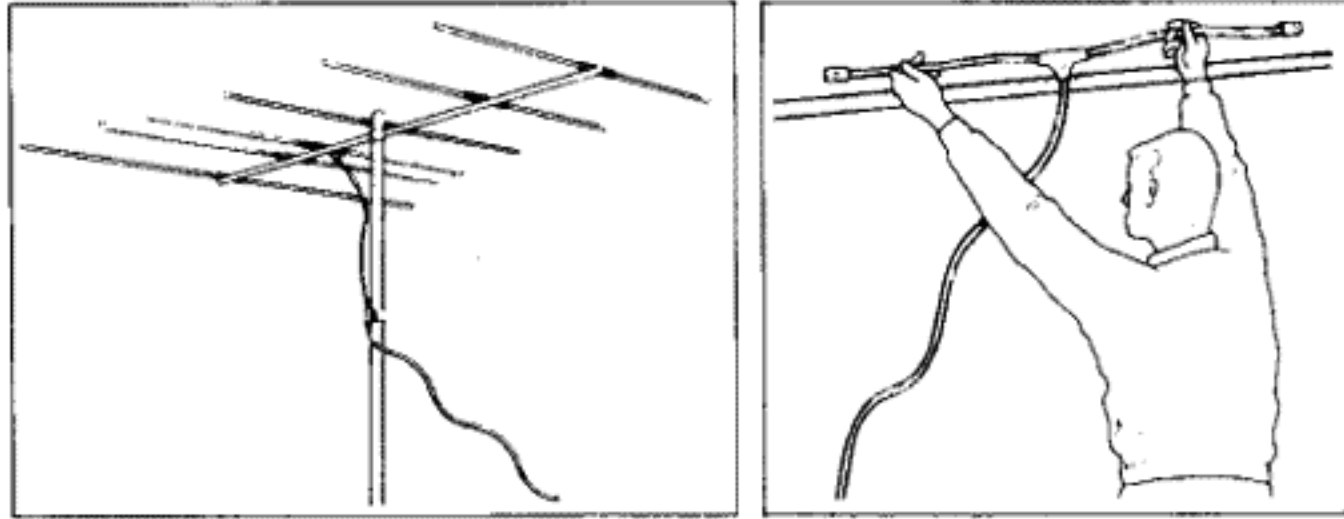

Connections

FM antenna

1. The antenna should be installed as high and as far away as possible from the street, railroad tracks and high-tension lines which can cause noise.
2. If the horizontally-extended part of the attached T-shaped antenna is not raised high enough, reproduction may be unstable, since signal paths are interrupted every time a person walks in the vicinity of the antenna.
3. The lead-in cable should be as short and as far away from power lines as possible. Simply cut off the extra length, if any. Be sure not to bundle it into a coil.
4. FM antennas possess directionality. Install a highly directional type antenna for improved noise-free reception.

Outdoor FM antenna

The antenna is a vital factor for low noise high sound quality FM reception. Install an outdoor FM antenna as described on pages 20, 21.

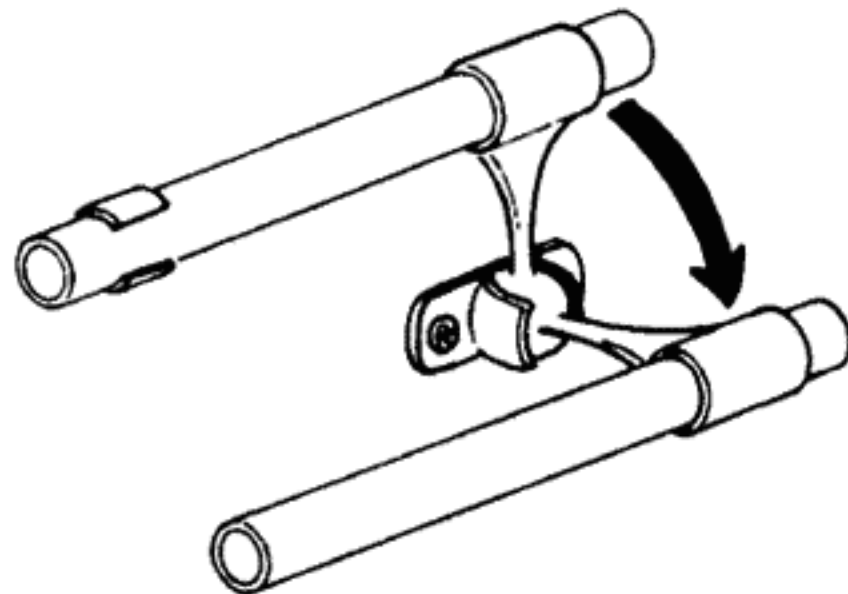

AM antenna

While actually listening to an AM station, pull the rear-panel bar antenna and align in the direction where you get the best reception. To avoid noise, do not run the power cable or speaker cables in the vicinity of the antenna.

Further advice for better AM reception.

1. Move the antenna away from the wall.
2. Place the unit near the window.
3. Re-align the unit itself.
4. Connect a PVC cord to the AM ANTENNA terminal and extend it outdoors.

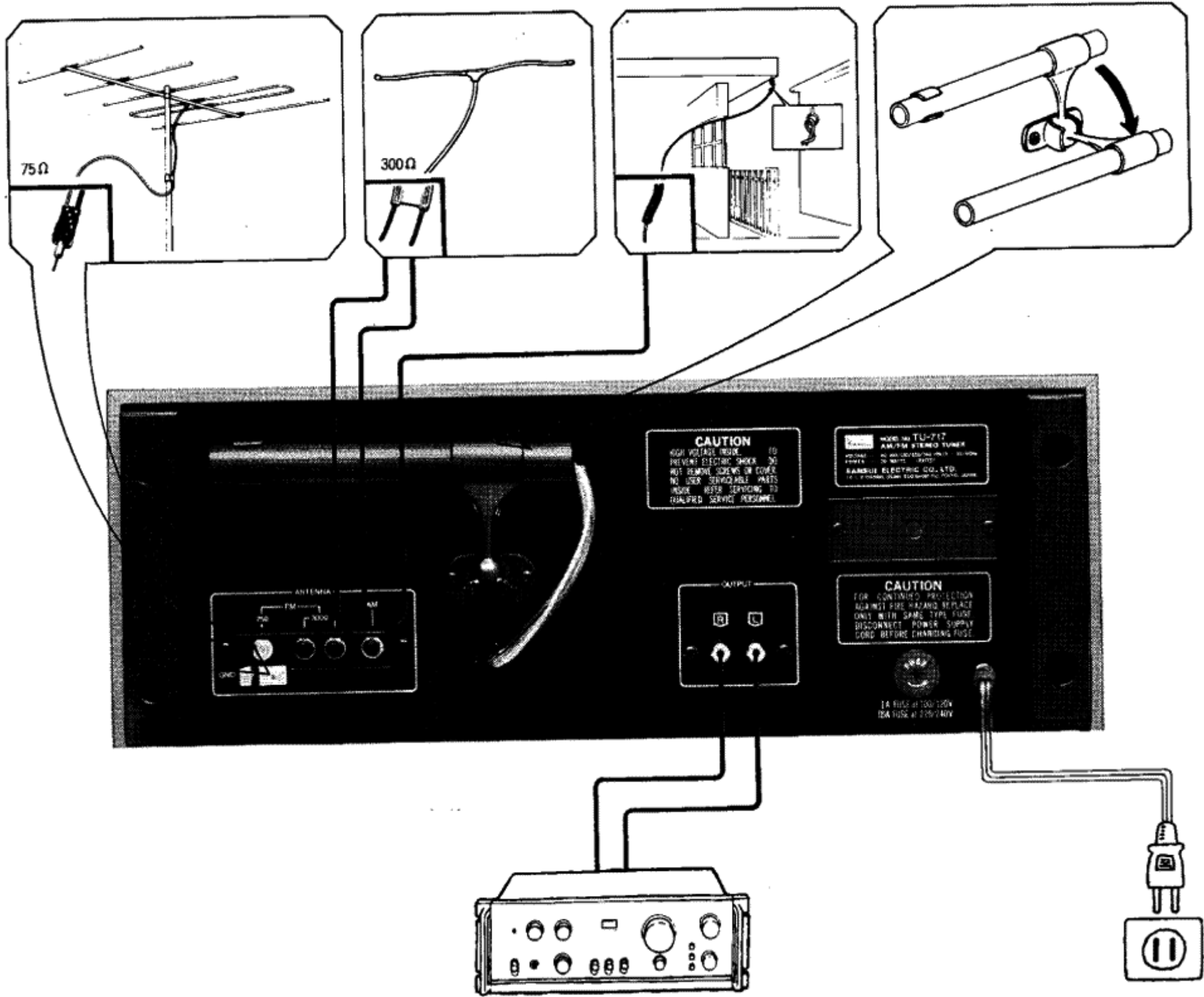

• This page folds out for use as reference while reading the rest of the booklet.

• Cette page se plie à l'extérieur pour l'utiliser comme référence tout en lisant le reste de la notice.

• Bitte klappen Sie diese Seite heraus, wenn Sie den Rest dieser Anleitung durchlesen.

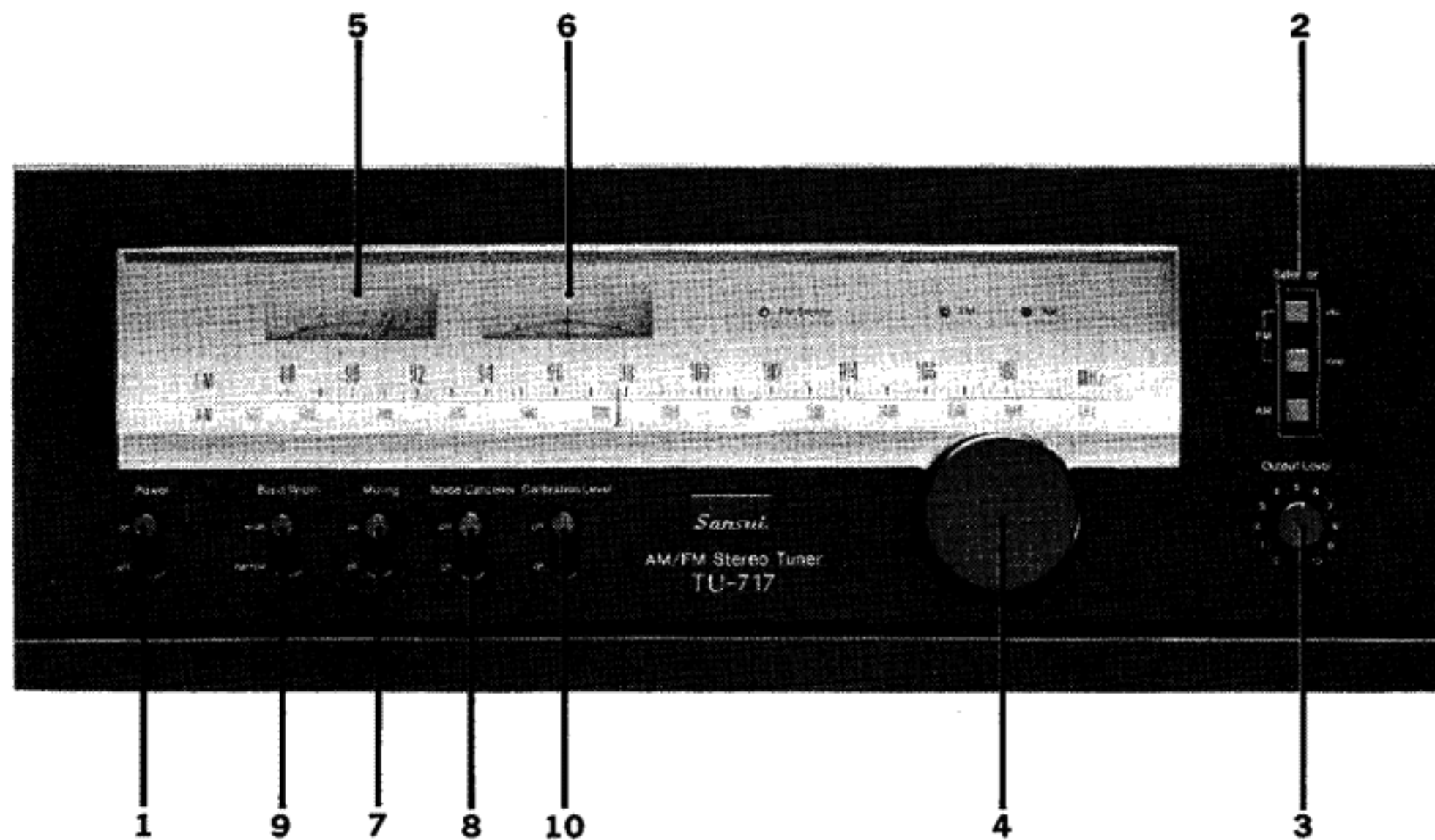

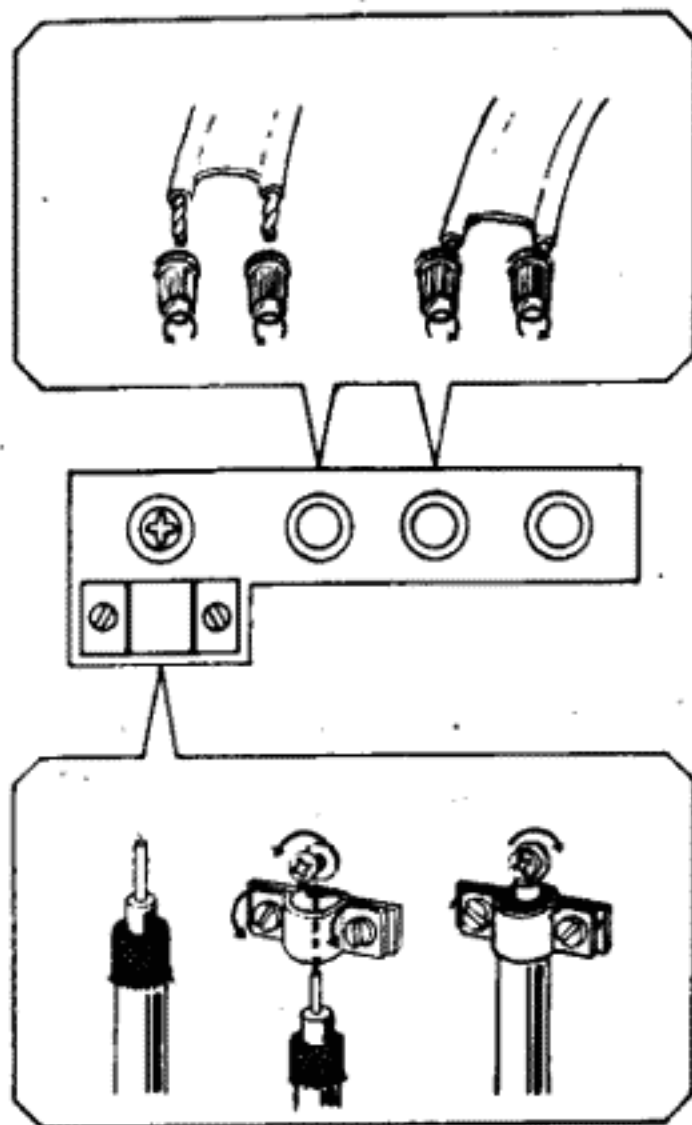

FM antenna connection

Use the FM 300-ohm terminals when connecting the T-shaped FM feeder antenna supplied or a 300-ohm lead-in cable from an outdoor antenna.

Use the FM 75-ohm terminal when connecting a 75-ohm coaxial cable from an outdoor antenna.

AM antenna connection

Connect a PVC cord to the AM ANTENNA terminal and extend the other end outdoors.

Amplifier connection

The supplied pin-plug cables should be used for connection between the unit's rear-panel OUTPUT terminals and your amplifier's TUNER (or AUX) terminals. Or they may be used to connect the unit's OUTPUT terminals with the deck's input terminals. Make sure not to confuse the left and right cables in connection.

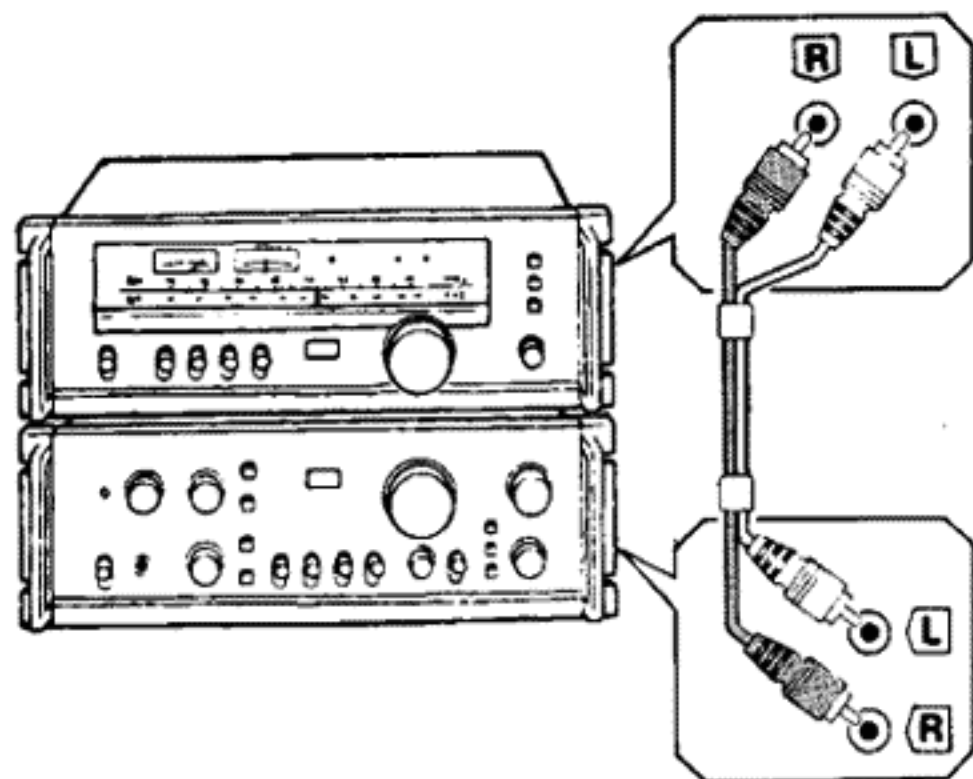

- * In order to simplify the explanation illustrations may sometimes differ from the originals.
- * Instructions and requirements indicated may vary to some extent depending on sales area, local laws and regulations.

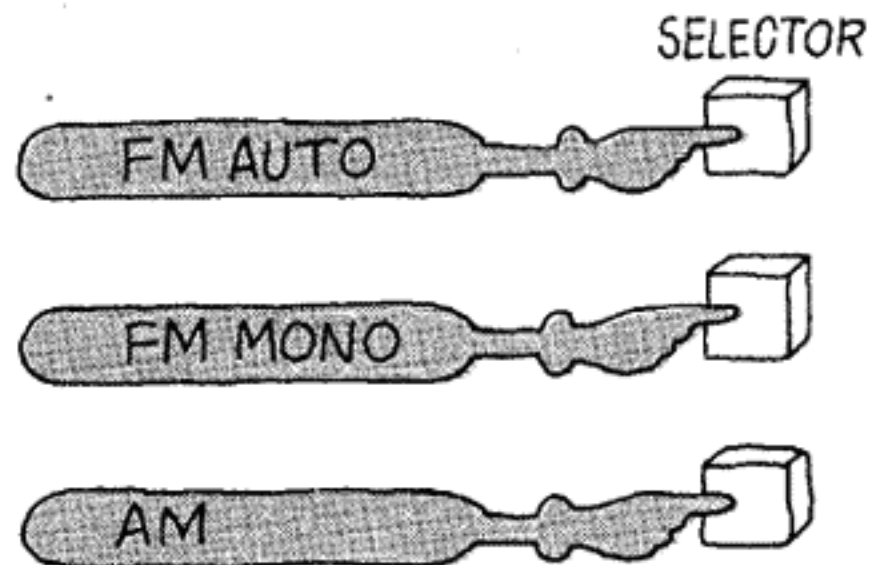

Panel information

1 POWER Switch

Raise the lever switch to ON to turn the unit on, push it down to OFF to turn it off.

2 SELECTOR Switch

This switch selects the band (AM or FM) you want to hear.

FM AUTO: To receive FM broadcasts. Use this position always (except for the case described below), whether you listen to FM stereo or mono broadcasts. The FM STEREO indicator lights up when the unit receives stereo signals.

FM MONO: To convert FM stereo broadcasts to mono.

AM: To receive AM broadcasts.

3 OUTPUT LEVEL Control

To achieve optimum output level, first turn the control up to a mid-way point, then select a station with the tuning control (described below). Play a tape or record, and match its output level with your unit's level. This saves you the trouble of adjusting the overall volume each time you switch one program source to another with your amplifier's controls.

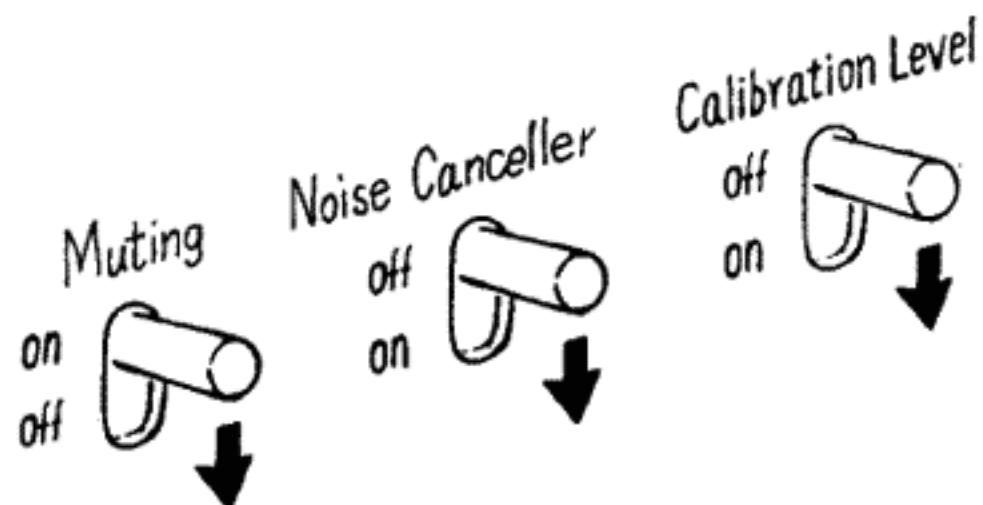
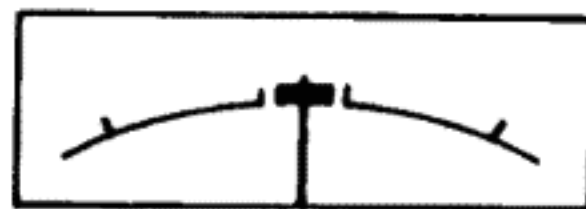
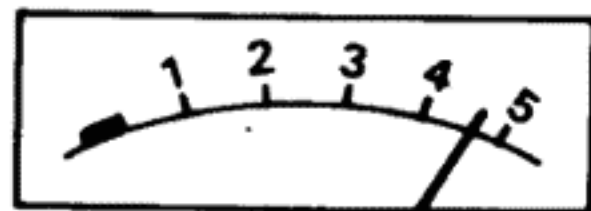

4 Tuning Control

5 SIGNAL Meter

6 TUNE Meter

The tuning control is used to tune a desired AM or FM station, as follows:

Tuning an AM station:

Your station is properly tuned when the SIGNAL meter needle registers maximum deflection to the right. The TUNE meter is for FM only.

Tuning an FM station:

Your station is properly tuned when the SIGNAL meter needle registers maximum deflection to the right and when the needle of the TUNE meter is accurately centered within the zone indicating maximum quality FM reception. The unit is tuned in on an FM station broadcasting in stereo automatically, and the FM STEREO indicator lights.

7 MUTING (FM) Switch

This MUTING switch eliminates weak signals as well as irritating inter-station noise. Push it (turning the circuit off) to receive weak-signal stations.

8 NOISE CANCELLER Switch

Push this button when you hear high-frequency noise during FM reception. Such noise can be due to weak signal strengths or to some extraneous causes. If the noise is still irritating, use the high filter switch on your amplifier if provided. And if noise is still heard during reception of FM broadcasts, set the unit's selector switch to the FM MONO position. Then you can enjoy noise-free reception, though in mono.

- Noise will be minimum when a high-quality antenna is used and lead-in connection is properly arranged. Such attention will result in improved tuning characteristics.

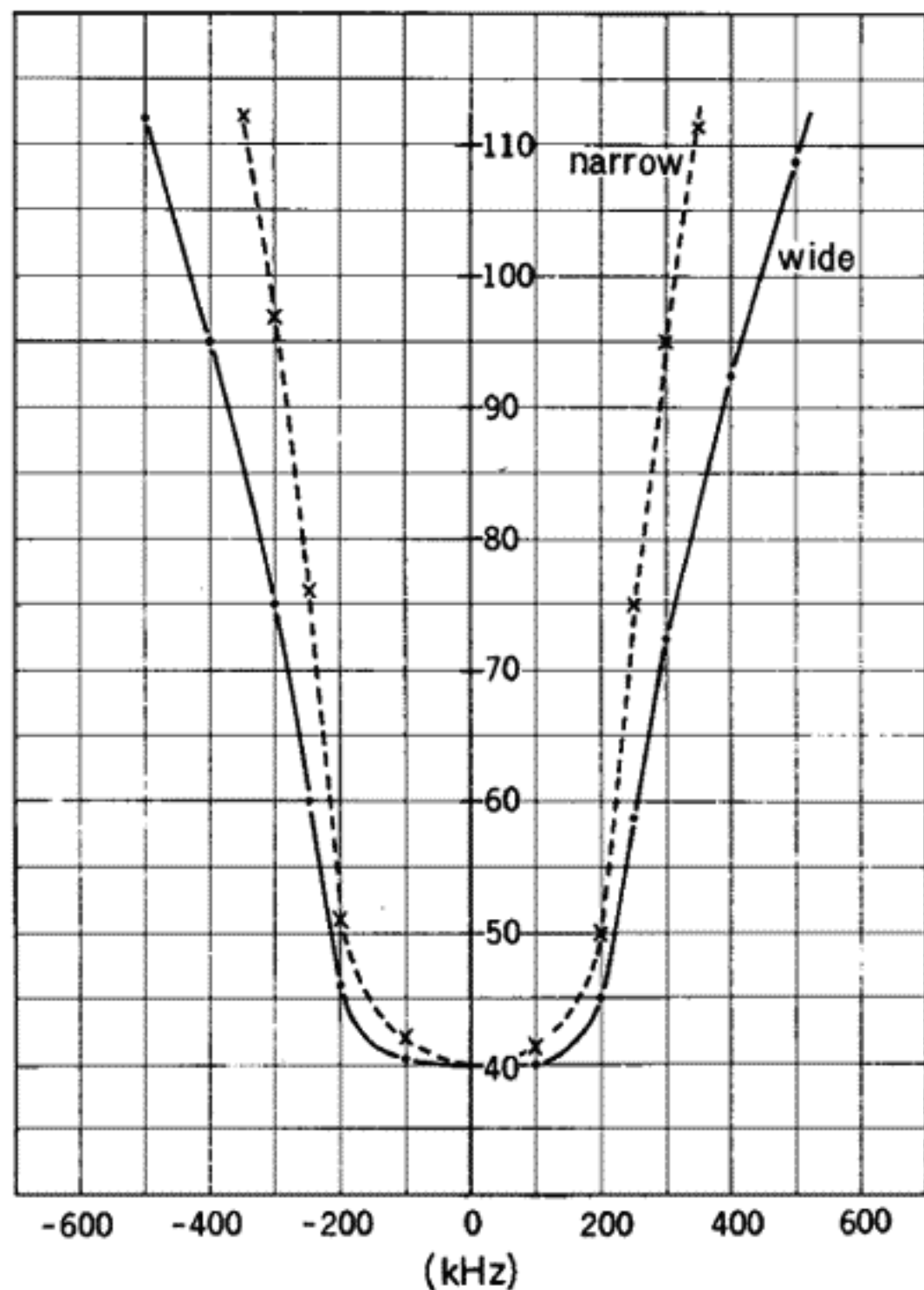

9 BAND WIDTH Switch

In FM multiplex stereo broadcasting, signals are transmitted over a bandwidth of 200 kHz. The wider bandwidth a receiver (tuner) has, the better sound quality it offers. Therefore, the BAND WIDTH switch should normally be up (WIDE).

However, if the signal you are receiving is interfered with by a nearby station, push the button (NARROW) to increase the tuner's selectivity.

- Interference from other stations may also be reduced by re-aligning your antenna, especially if your antenna is highly directional.

10 CALIBRATION LEVEL Switch

This switch helps you set the appropriate recording level when recording an FM broadcast. When pushed down, it activates the built-in test-signal generator. The procedure is: Push the button; adjust the level controls on your tape deck so that the level meters indicate -3 dB (VU); and push the button again to de-activate the generator.

Level adjustment with your tape deck

The test signal is -3 dB in reference to the 100% FM modulation, or to the tape deck's rated recording level (0 dB). Therefore, if you set the recording level to -3 dB, you can record almost any broadcast with good quality without the risk of overloading your tape with peak-level signals.

Since stations sometimes send out signals as much as +3 dB over 100% modulation, you can further avoid overloading the tape if both the deck and tape you use have a dynamic margin or "headroom" (the range between the rated level and the maximum level) of +3 dB. And since tape decks and tapes have each a different optimum level, try to determine the co-relation between the quality of recorded signals and the level at which the test signal is recorded.

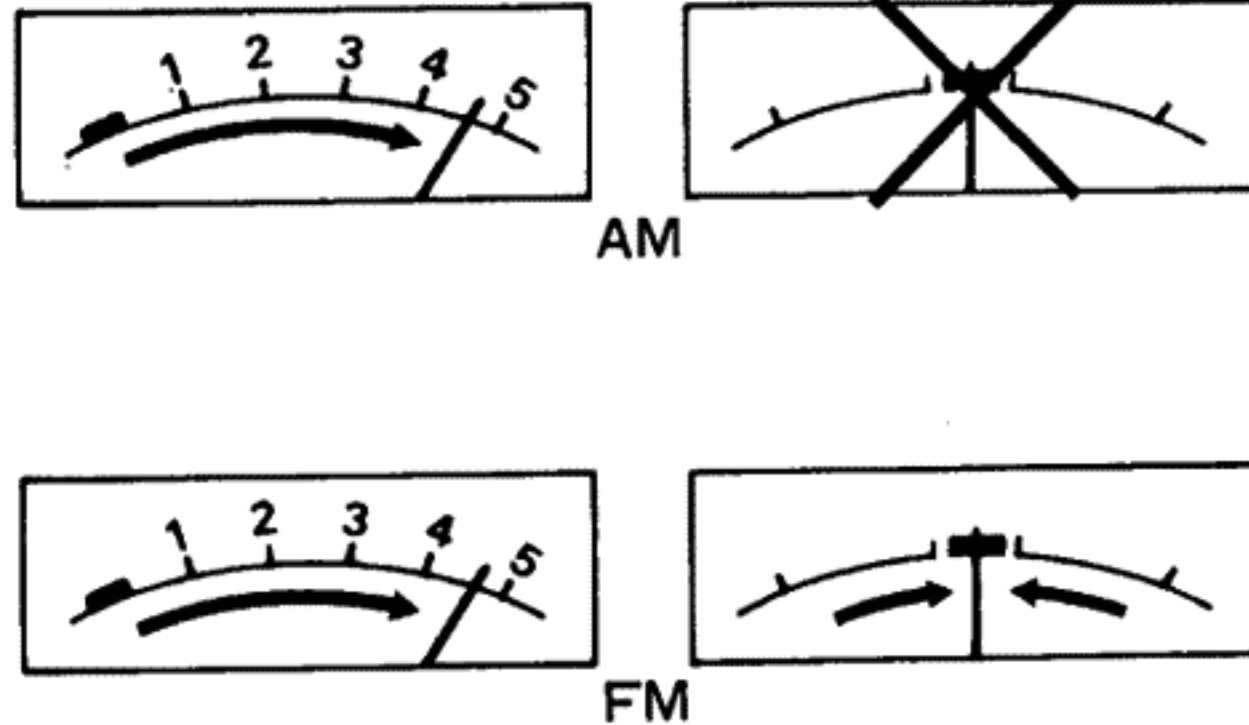

Operating procedures

Listening to radio broadcasts

1. Confirm that the VOLUME control is not turned too far to the right; it should be at a position where you can obtain the normal listening level.
2. Set the SELECTOR switch to AM or FM AUTO, depending on the band you are about to hear.
3. Adjust the Tuning control and tune in the desired station.

Tuning an AM station:

Your station is properly tuned when the SIGNAL meter needle registers maximum deflection to the right. The TUNE meter is for FM only.

Tuning an FM station:

Your station is properly tuned when the SIGNAL meter needle registers maximum deflection to the right and when the needle of the TUNE meter is accurately centered within the zone indicating maximum quality FM reception.

To tune in a weak-strength or fringe-area FM station, first push the MUTING switch.

Noise during radio reception

- * Weak FM signals are often disturbed by ignition noise from nearby automobiles and other noise. Therefore, for better FM reception, installation of an outdoor FM antenna is suggested. For antenna connection, be sure to use a coaxial cable, not a feeder-type cable.
- * When you hear noise during AM reception, there are innumerable conceivable causes, which makes it almost impossible to eliminate all AM noises. Use the unit's filters when grounding the unit or mounting a noise-eliminating device fails to reduce such noise.

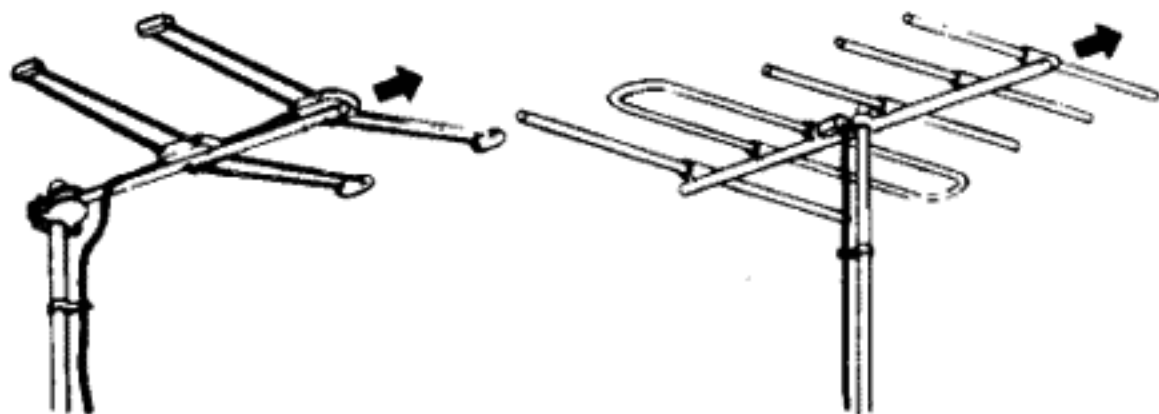
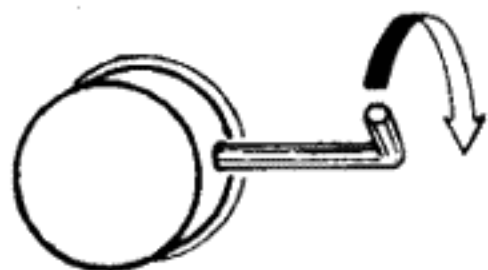

Some useful hints

Hexagonal wrench

When the screw in the knob becomes loose, use the hexagonal wrench provided, and tighten it as shown in the illustration. The hexagonal wrench is very small and light in weight. Be careful not to lose it.

Outdoor FM antenna installation

For noise-free high-quality radio reception, an antenna is indispensable. Install an outdoor FM antenna referring to instructions on page 22 and 23. You can then avoid ignition noise and other type of noise as well as tonal deterioration by multi-path reflections. Antennas are prerequisite for quality FM reception in areas far from radio stations or in areas where there are high-rise buildings, mountains or other wave-reflecting objects.

The T-shaped FM antenna supplied should be used only until you install an outdoor antenna.

The lead-in cable should be of the 75-ohm coaxial type, for it suppresses intrusion of noise more effectively than the 300-ohm twin lead type.

- Since you have to select the FM antenna and lead-in cable best suited for your area, you are advised to consult with your nearest electric appliance dealer prior to purchase.

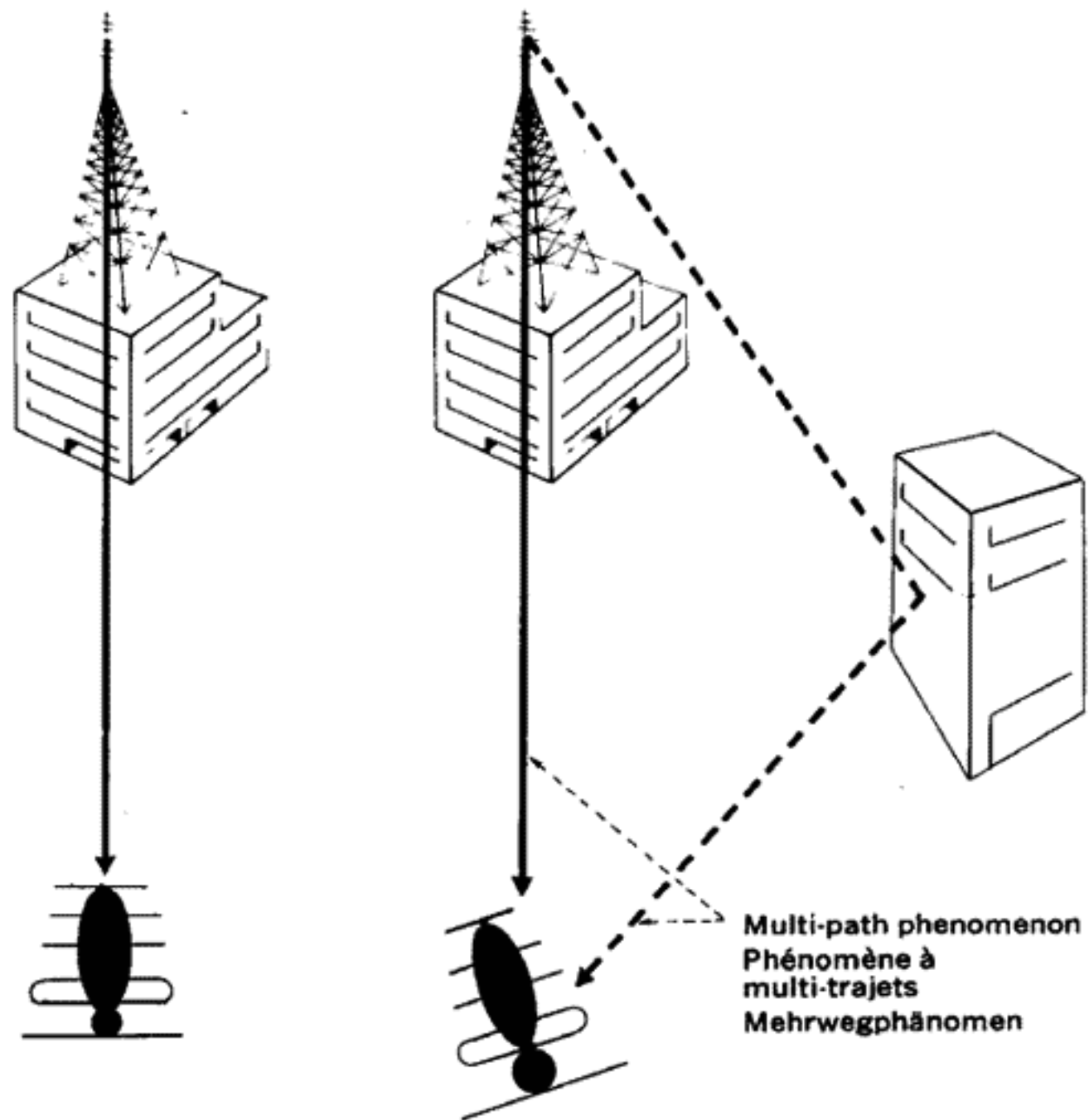

For better FM reception

Compared with AM, FM is inherently of higher quality with less noise and less interferences. Here are some hints for further improved FM reception.

Multi-path phenomenon and antenna alignment

FM waves are directional (more directional than AM), possessing a tendency to beam in a straight line. When hitting an obstacle, they simply reflect. Antennas receive the waves reflected by nearby obstacles (such as mountains and tall building) as well as the wave beamed direct from the station. The result is a multi-path phenomenon, the same problem which is the cause of "ghosts" on TV screen. In FM, reflection can cause distortion and poor stereo separation. Use an FM antenna with good directionality and align it correctly to minimize such distortion.

When hearing FM noise

As mentioned above, FM offers less noisy reproduction. However, noise may be increased by the causes described below.

Weak antenna input—When antenna input is too weak, the signal-to-noise ratio (the relative levels of the desired signal vs. the noise generated inside the unit and by extraneous signals) may deteriorate.

The causes may be:

- * Improper antenna location.
- * Use of a low-gain T-shaped antenna. (Replace it for an outdoor antenna.)

Nearby electric appliances—Pulsive noises, caused by electrical sparks, may be mixed into audio signals. Major sources of such noises are automobiles (ignition plugs), electric trains, high-tension lines, fluorescent lamps, welding machines, etc. Therefore, you suffer less noise when the antenna is placed as far away as possible from such sources of noise.

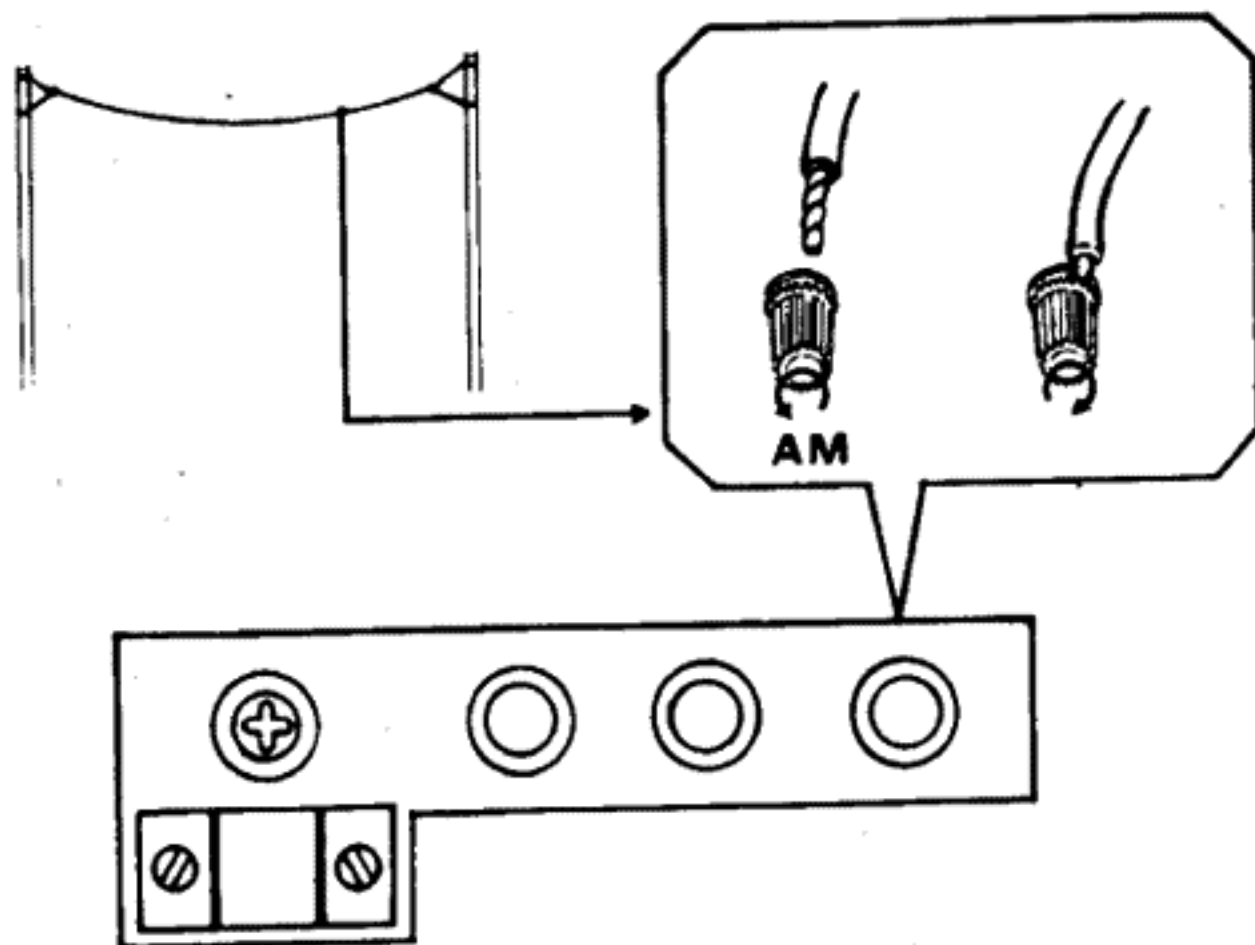

For better AM reception

Following are some hints for better AM reception.

When receiving weak stations:

When the unit is tuned to a weak AM station, you hear lower volume than when it receives a strong one. This may be corrected by re-aligning the rear-panel AM ferrite bar antenna. If the unit is used in a concrete building, AM volume may be increased by placing it by a window or air shaft. For best AM reception, you are advised to install an outdoor AM antenna.

When hearing AM noise:

AM noise can be caused by one of the following reasons.

Interference—Interference causes an audible, high-pitched beat. To avoid it, re-align the direction of the antenna. Also note that an outdoor antenna may also increase the noise level of a desired station by accidentally pulling in interference from other stations. Re-alignment in this case is also necessary.

Hum—Booming hum noise is often caused by the power source and is heard as 60 Hz (or 50 Hz) sound. It may be reduced by moving the unit away from other electric appliances or by reversing the unit's power cord plug/receptacle connections. Proper grounding may also be effective in reducing hum.

Buzz—Buzz noise is caused by fluorescent lamps and other electric appliances, or by natural phenomena such as thunder. Installation of a noise-suppression device may be effective. Since complete elimination of AM buzz is usually impossible, it is suggested that you make it less audible with the high filter or treble tone control on your amplifier.

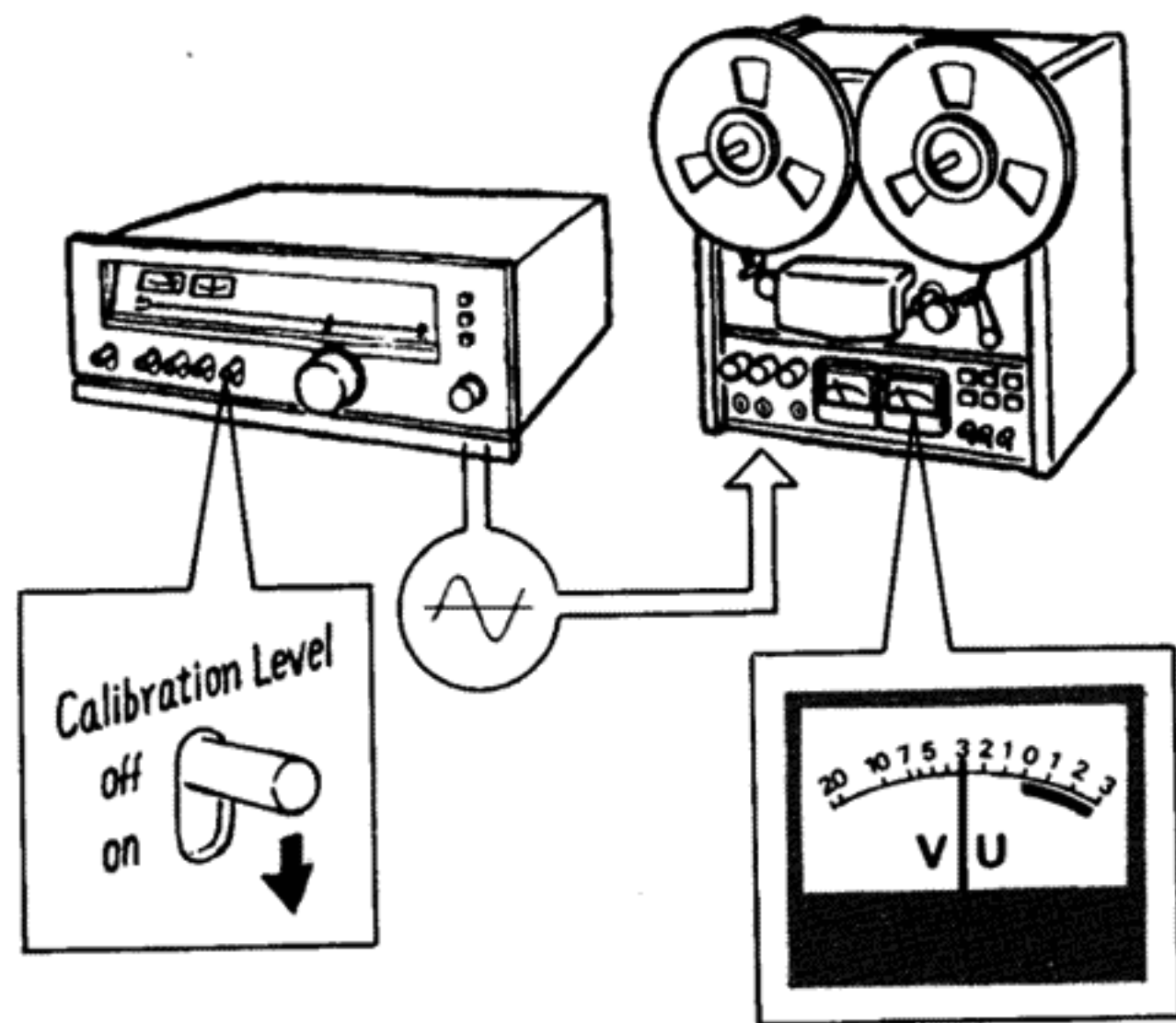

Recording FM broadcast

1. First, connections must be made between the unit and your amplifier, and between the amplifier and your tape deck.
 2. Push down the CALIBRATION LEVEL switch to ON' Then a 400 Hz colibration signal appears at the unit's OUTPUT terminals.
 3. Adjust the recording level controls on the tape deck so that its built-in VU meters indicate -3 DB (VU).
 4. Raise the CALIBRATION LEVEL switch on the unit to OFF.
 5. Select the FM position, AUTO or MONO. Then you're ready to record.
- The OUTPUT LEVEL control also adjusts the level of the calibration signal. Therefore, once the recording level is set, do not tamper with the OUTPUT LEVEL control.

About BAND WIDTH Switch

This switch selects the IF bandwidth, WIDE or NARROW. When there's a strong-signal local station near the station you've tuned in, use the NARROW position; selectivity is then improved and interference effectively rejected. If there's no strong-signal station nearby, use the WIDE position to enjoy the best possible tonal quality in FM reception.

- Be sure to select one or the other. When the switch is positioned anywhere between the WIDE and NARROW positions, sound might not come from the connected speakers.

About rack mounting adaptors

Remarques concernant les adaptateurs de montage d'étagères

Zu den Haltekonsole für die Regalmontage

28

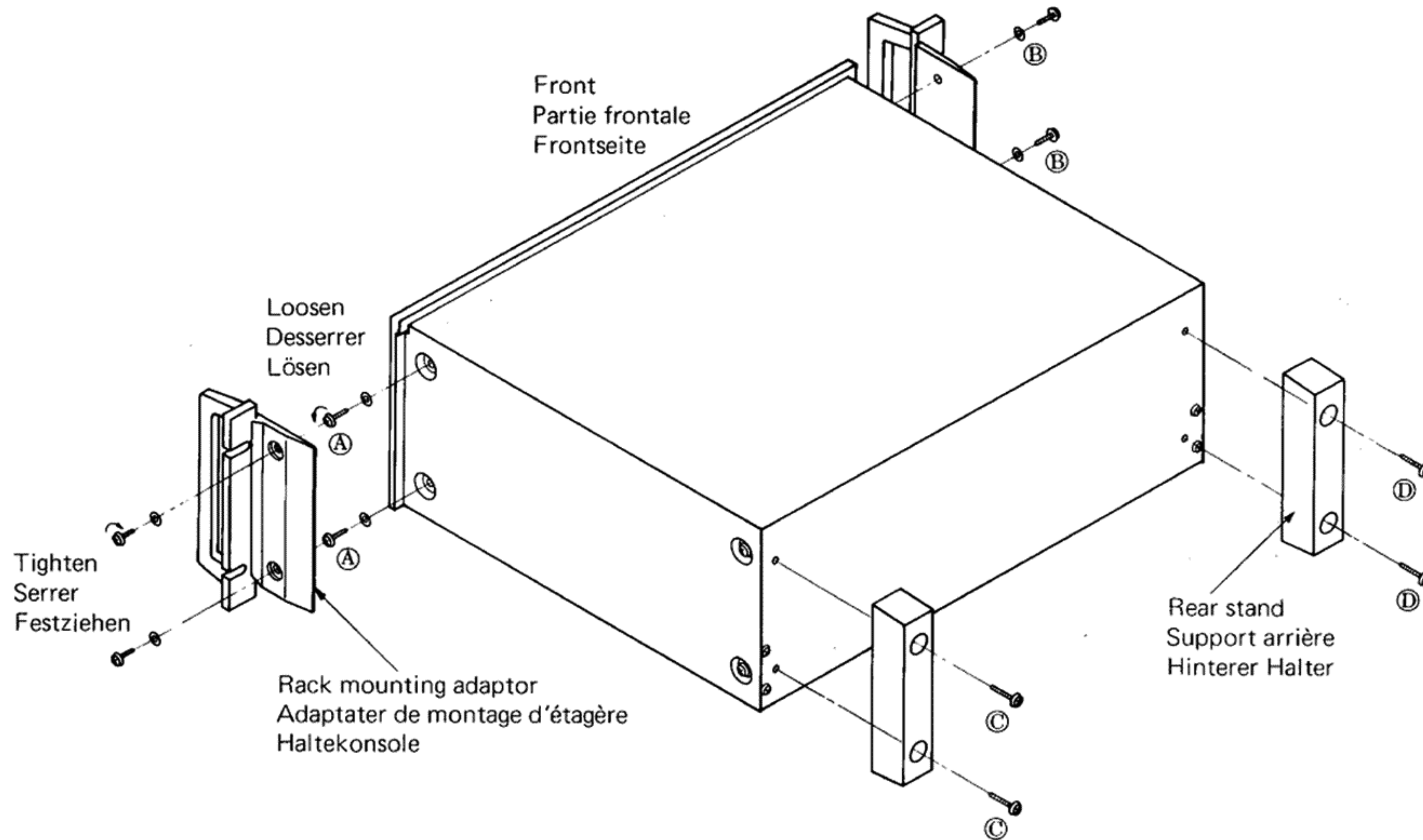

HOW TO ATTACH RACK MOUNTING ADAPTORS

1. Remove screws (A) and (B) using a screwdriver.
 2. Fasten the rack mounting adaptors with the four screws removed above.
 3. Fasten the two rear stands using the four accompanying screws ((C) and (D)).
- Tighten all screws firmly.
 - Both the rack mounting adaptors and rear stands are identical for the left and right sides.
 - The pitch of the rack mounting adaptors is in accordance with the EIA specifications.

Caution: Do NOT ever remove any screws other than those indicated as (A) and (B) in the illustration.

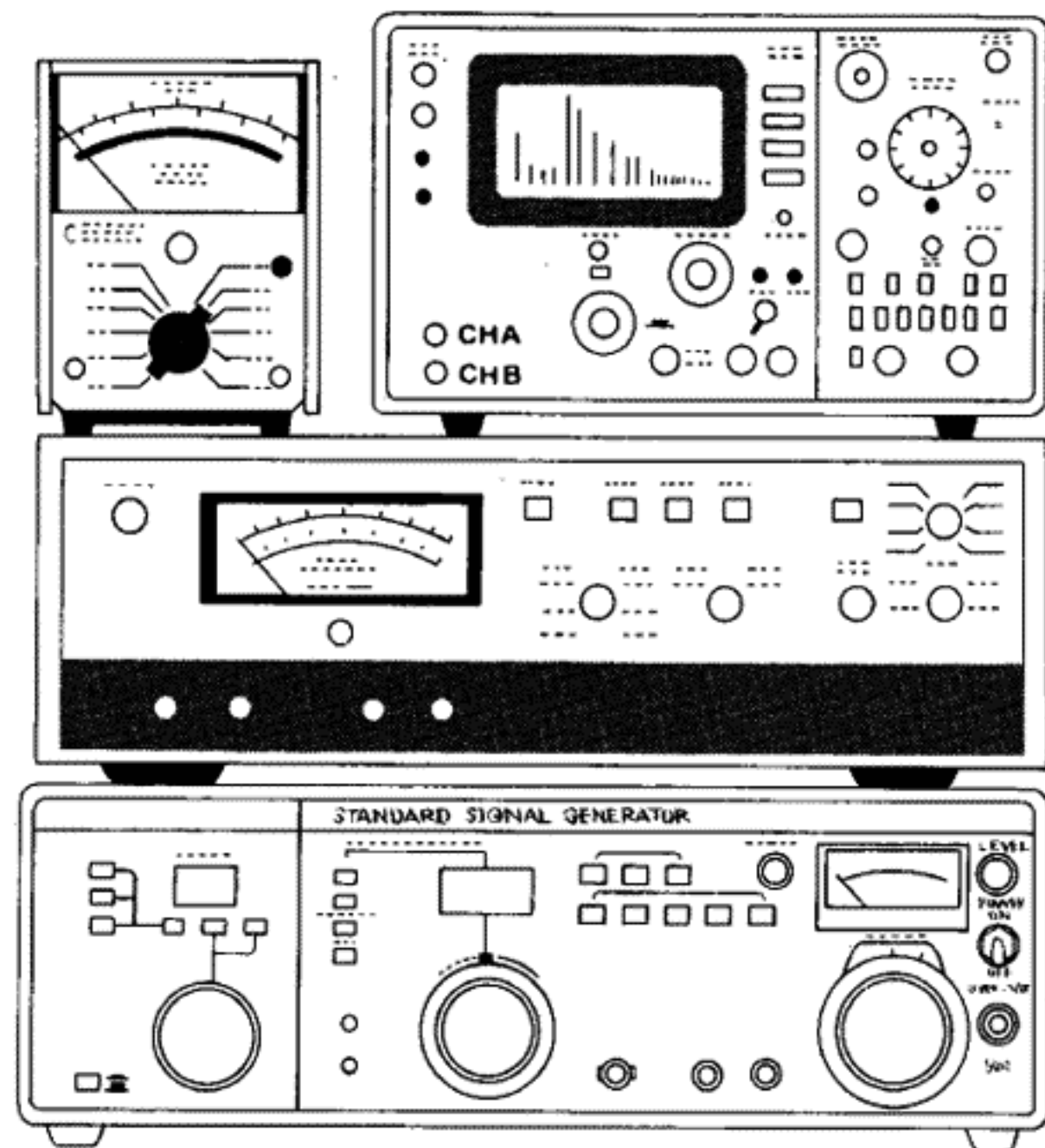

Specifications

FM Section

Tuning range	88 to 108 MHz
Usable Sensitivity	
Mono IHF	9.8 dBf (1.7 μ V: T100)
Stereo IHF	19.0 dBf (4.9 μ V)
50 dB Quieting Sensitivity	
Mono	12.5 dBf (2.24 μ V)
Stereo	34 dBf (27.5 μ V)
Signal to noise ratio at 65 dBf	
Mono	81 dB
Stereo	78 dB
Distortion (at 65 dBf)	
Mono: Wide	less than 0.06% at 100 Hz less than 0.06% at 1,000 Hz less than 0.08% at 6,000 Hz
Narrow	less than 0.18% at 100 Hz less than 0.15% at 1,000 Hz less than 0.2% at 6,000 Hz
Stereo: Wide	less than 0.1% at 100 Hz less than 0.07% at 1,000 Hz less than 0.1% at 6,000 Hz
Narrow	less than 0.22% at 100 Hz less than 0.2% at 1,000 Hz less than 0.25% at 6,000 Hz
Adjacent channel selectivity (at 200 kHz)	
Wide	3.5 dB
Narrow	8.0 dB
Alternate channel selectivity (at 400 kHz)	
Wide	50 dB
Narrow	80 dB
Capture ratio	
Wide	1.0 dB
Narrow	1.5 dB

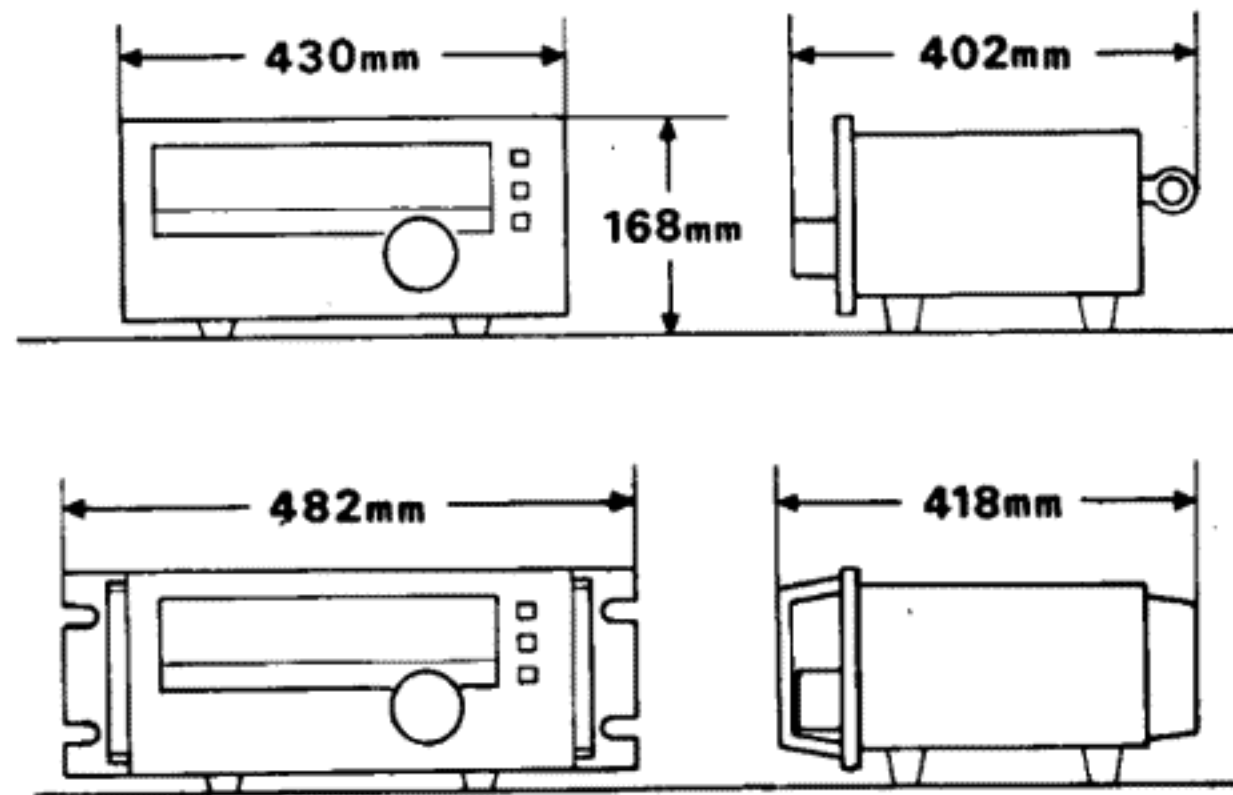

Image response ratio	86 dB (at 98 MHz)
Spurious response ratio	90 dB (at 98 MHz)
Stereo separation	
Wide	45 dB at 100 Hz 48 dB at 1,000 Hz 38 dB at 10,000 Hz 36 dB at 30 ~ 15,000 Hz
Frequency response	30 to 15,000 Hz +0.2 dB -1 dB
Antenna input impedance	300 ohms balanced 75 ohms unbalanced

AM Section

Tuning range	530 to 1,600 kHz
Usable sensitivity (Bar antenna)	47 dB/m (220 μ V/m)
Selectivity (± 10 kHz)	35 dB
Signal to noise ratio	52 dB
Distortion at 80 dB/m	0.35%

Others

Output level	
Output	0 to 1 V
Power requirements	100, 120, 220, 240 V 50/60 Hz
For U.S.A. for Canada	120 V (60 Hz)
Power consumption	20 W
Weight	9.2 kg (20.3 lbs) net 11.0 kg (24.3 lbs) packed

* Design and specifications subject to change without notice for improvements.

The Sansui logo consists of the word "Sansui" in a white, italicized serif font, set against a solid black rectangular background.

SANSUI ELECTRIC CO., LTD.

14-1 Izumi 2-Chome, Suginami-ku, TOKYO 168, JAPAN
TELEPHONE: (03) 323-1111/TELEX. 232-2076