

# ***Compact Disc Player***

---

Operating Instructions



*CDP-397  
CDP-297*

# Warning

## Owner's Record

The model and serial numbers are located at the rear. Record these numbers in the space provided below. Refer to these numbers whenever you call upon your Sony dealer regarding this product.

Model No. \_\_\_\_\_ Serial No. \_\_\_\_\_

**Do not prevent fire or shock hazard, do not expose the unit to rain or moisture.**



**CAUTION**  
RISK OF ELECTRIC SHOCK  
DO NOT OPEN



**CAUTION : TO REDUCE THE RISK OF ELECTRIC SHOCK,**

**DO NOT REMOVE COVER (OR BACK).**

**NO USER-SERVICEABLE PARTS INSIDE.**

**REFER SERVICING TO QUALIFIED SERVICE PERSONNEL.**



This symbol is intended to alert the user to the presence of uninsulated "dangerous voltage" within the product's enclosure that may be of sufficient magnitude to constitute a risk of electric shock to persons.



This symbol is intended to alert the user to the presence of important operating and maintenance (servicing) instructions in the literature accompanying the appliance.

## WARNING

This equipment has been tested and found to comply with the limits for a Class B digital device, pursuant to Part 15 of the FCC Rules. These limits are designed to provide reasonable protection against harmful interference in a residential installation. This equipment generates, uses, and can radiate radio frequency energy and, if not installed and used in accordance with the instructions, may cause harmful interference to radio communications. However, there is no guarantee that interference will not occur in a particular installation. If this equipment does cause harmful interference to radio or television reception, which can be determined by turning the equipment off and on, the user is encouraged to try to correct the interference by one or more of the following measures:

- Reorient or relocate the receiving antenna.
- Increase the separation between the equipment and receiver.
- Connect the equipment into an outlet on a circuit different from that to which the receiver is connected.
- Consult the dealer or an experienced radio/TV technician for help.

You are cautioned that any changes or modifications not expressly approved in this manual could void your authority to operate this equipment.

# Table of Contents

<b>Chapter 1 Introduction</b>	
Overview .....	3
Safety precautions .....	4
<b>Chapter 2 Getting Started</b>	
Unpacking .....	4
Choosing a good location .....	4
Checking the supplied accessories .....	4
Inserting the batteries into the remote commander (only for CDP-397) .....	5
Hooking up the system .....	5
Notes on connection .....	5
Identifying the parts .....	6
Front panel .....	6
Remote commander (only for CDP-397) .....	6
<b>Chapter 3 Basic Operations</b>	
Playing a disc .....	7
Inserting a disc .....	7
Playing the entire disc .....	8
Information display .....	8
Locating a particular selection .....	9
Locating a particular point in a selection .....	9
Playing selections in a random order .....	10
Shuffle play .....	10
Delete shuffle play .....	11
Playing in a desired order .....	12
Program play .....	12
Checking and changing the program .....	13
Playing only desired selections .....	14
Delete play .....	14
Playing the beginning of each selection .....	15
Music scan play .....	15
Music scan delete play .....	16
Playing repeatedly .....	17
Repeat play .....	17
Fading in/fading out .....	18
Designating the fading duration .....	18
Ending play fading out .....	18
Restarting play fading in .....	18
<b>Chapter 4 Advanced Operation</b>	
Recording a program (only for CDP-397) .....	19
Programming and recording .....	19
Designating the total playing time .....	21
Making a program with editing functions .....	21
Playing the program .....	22
Locating the portion with the highest volume — Peak search .....	23
Fading out at the desired time — Time fade .....	24
<b>Chapter 5 Additional Information</b>	
Maintenance .....	25
Cleaning your unit .....	25
Cleaning discs .....	25
Specifications .....	25
Troubleshooting guide .....	26

# Overview

## Enjoy listening in various playing modes

You can select playing modes from among the following:

- Continuous play (page 8) — The entire disc is played once.
- Shuffle play (page 10) — Selections are played in a random order.
- Program play (page 12) — Selections are played in your desired order.
- Delete play (page 14) — Desired selections are played in the order on the disc.
- Repeat play (page 17) — Selections or a portion is played repeatedly.

## Playing the beginning of all selections — Music scan

You can play the beginning of each selection consecutively to decide which selection to play. (page 15)

## Editing your own tapes

- You can fade the play in or out when making your own tape recording. — Fading in/Fading out (page 18)
- CUSTOM EDIT function
  - You can confirm the total playing time while choosing the selections to be programmed. — Program edit (page 19)
  - The unit can program selections automatically to fit in a desired duration. — Time edit/Just edit (page 21)
  - You can locate the portion with the highest volume (the peak of the input level) to adjust the recording level — Peak search (page 23)
  - You can stop the play, fading out at the time desired. — Time fade (page 24)

## Note

In the instructions starting from page 8, buttons on the remote commander are indicated in parentheses, unless mentioned otherwise. Remember the remote commander is supplied only for CDP-397.

# Safety Precautions

Before operating the unit, please read the following precautions carefully.

- Operate the unit only on 120 V AC, 60 Hz.
- Stop operation immediately if any liquid or solid object should fall into the cabinet. Unplug the unit and have it checked by qualified personnel.
- Unplug the unit from the wall outlet if you do not use it for a long time. Disconnect the cord by grasping the plug. Never pull the cord itself.
- The unit is not disconnected from the mains as long as it is plugged into the wall outlet, even if the unit itself has been turned off.
- Do not disassemble the cabinet. The laser beam used in this unit is harmful to the eyes when uncovered. Refer servicing to qualified personnel only.

## Notes on handling discs

- To keep the disc clean, handle the disc by its edge. Do not touch the surface.



- Do not stick paper or tape on the disc.



- Do not expose the disc to direct sunlight or heat sources such as hot air ducts, nor leave it in a car parked in direct sunlight as there can be a considerable rise in the temperature.
- After playing, store the disc in its case.

## Caution on adjusting volume

Do not turn up the volume while listening to a portion with very low level inputs or no audio signals. If you do, the speakers may be damaged when a peak level portion is played.

For detailed safety precautions, see the leaflet "IMPORTANT SAFEGUARDS".

If you have any questions or problems concerning your unit, please contact your nearest Sony dealer.

# Unpacking

## Choosing a Good Location

- Place the unit in a location with adequate air circulation to prevent internal heat built up in the unit
- Do not place the unit on a soft surface, such as a rug that might block the ventilation holes on the bottom.
- Do not install the unit:
  - near heat sources such as radiators or air ducts.
  - in a place subject to direct sunlight, excessive dust, mechanical vibration or shock.

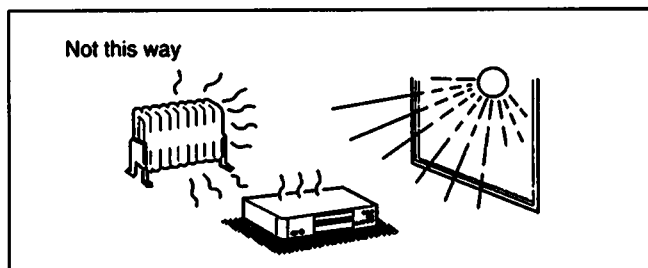

## On moisture condensation

If the unit is brought directly from a cold to a warm location, or is placed in a very damp room, moisture may condense on the lens inside the unit. Should this occur, the unit will not operate. In this case, remove the disc and leave the unit turned on for about an hour until the moisture evaporates.

## Checking the Supplied Accessories

Make sure that all supplied accessories are included with your unit. This manual and the following items must be included with your CDP-397/297.

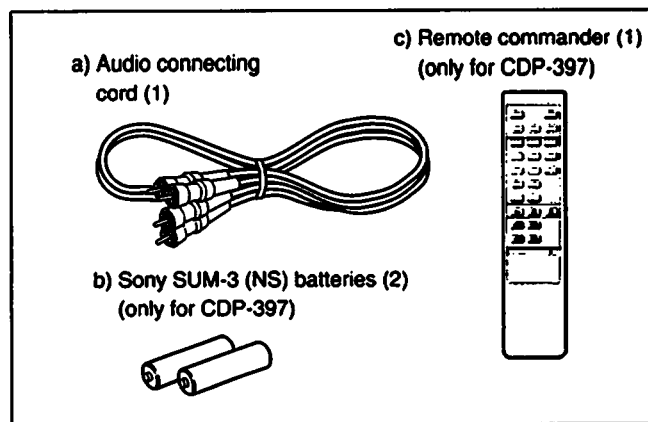

Do not throw away the carton and the packing material. They will come in handy when transporting the unit or shipping it for servicing.

# Hooking Up the System

## Inserting the Batteries into the Remote Commander (only for CDP-397)

You can control the unit with the supplied remote commander.

Insert two size AA (R6) batteries with the correct polarity.

**1** Slide the cover to remove it.

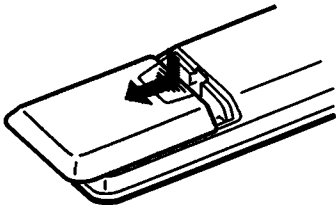

**2** Insert two size AA (R6) batteries correctly so that the ⊕ and ⊖ polarities match the polarity diagrams inside the battery compartment.

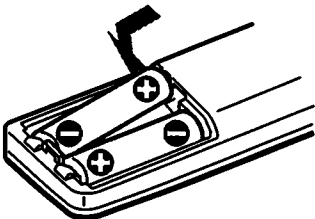

### On battery life

- About half a year of normal operation can be expected when using size AA (R6) batteries.
- When the batteries are run down, the remote commander will not operate the unit. In this case, replace both batteries with new ones.

### Notes on the remote commander and remote control operation

- Keep the commander away from extremely hot or humid places.
- Avoid dropping any foreign objects into the commander casing, particularly when replacing the batteries.
- Avoid exposing the remote sensor to direct sunlight or lighting apparatus. Such exposure can cause a malfunction.
- To avoid damage caused by battery leakage and corrosion, remove the batteries when the commander will not be used for a long time.

### Convention



This indicates a function operated only on the main unit.

Connect the unit to an amplifier as shown below.

## Notes on Connection

Before you begin, remember the following.

- Turn off the power of each unit before making connections. Connect the AC power cord last.
- Be sure to insert the plugs firmly into the jacks. Loose connection may cause hum and noise.
- Leave a little slack in the connecting cord to allow for inadvertent shock or vibration.

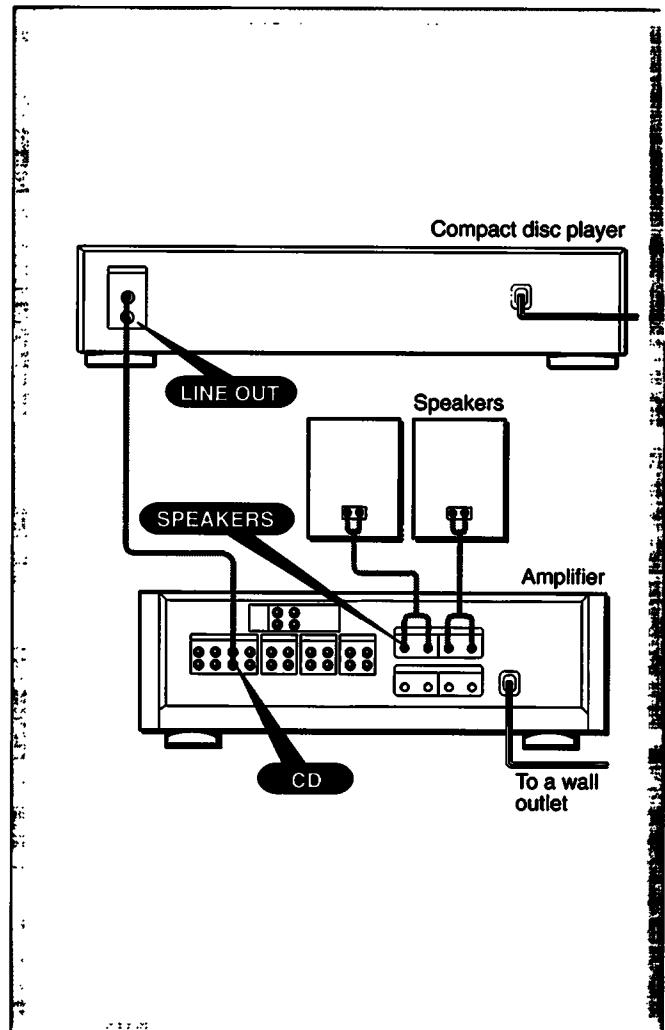

# Identifying the Parts

Refer to the pages indicated in parentheses for details.

## Front Panel

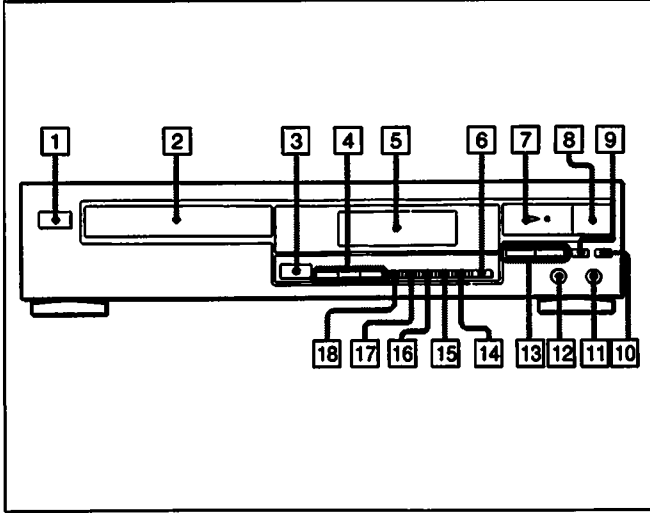

- 1 POWER switch (page 7)
- 2 Disc tray (page 7)
- 3 ▲ OPEN/CLOSE button (page 7)
- 4 Play mode buttons  
CONTINUE button (pages 10, 12, 14)  
SHUFFLE button (pages 10, 11, 12, 14)  
PROGRAM button (pages 12, 19)
- 5 Display window (page 7)
- 6 PEAK SEARCH button (page 23)
- 7 ►|| (play/pause) button (page 8)
- 8 ■ (stop) button (page 8)
- 9 EDIT/TIME FADE button (pages 21, 24)
- 10 MUSIC SCAN button (page 15, 16)
- 11 PHONE LEVEL control
- 12 PHONES jack
- 13 ◀◀ ▶▶ (AMS\*/RMS\*\*) buttons  
(pages 9, 12, 18, 19, 21, 24)
- 14 FADER button (page 18)
- 15 REPEAT button (page 17)
- 16 TIME button (page 8)
- 17 CLEAR (program clear) button (pages 13, 14, 16)
- 18 CHECK (program check) button (page 13)

\* AMS is the abbreviation of Automatic Music Sensor  
\*\*RMS is the abbreviation of Random Music Sensor.

## Remote Commander (only for CDP-397)

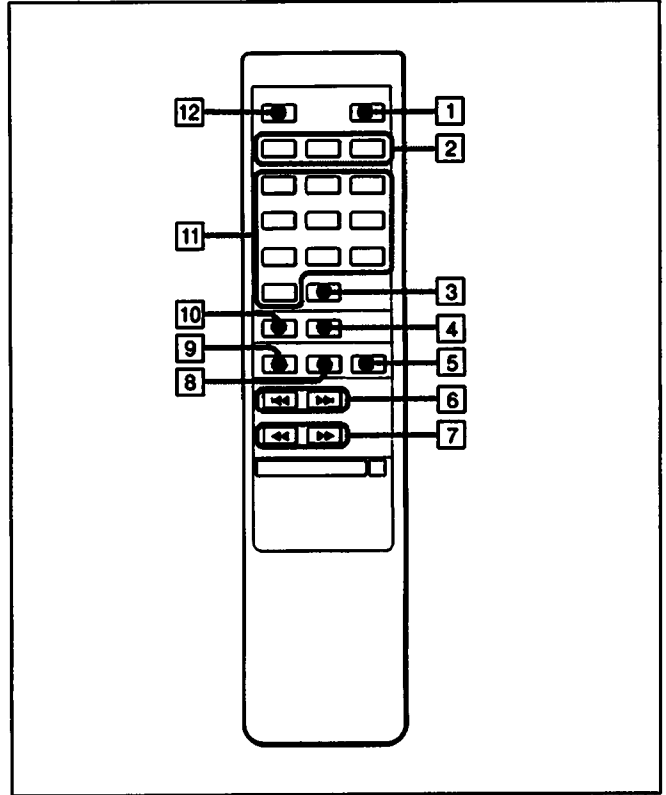

- 1 FADER button (page 18)
- 2 Play mode buttons  
CONTINUE button (pages 10, 12, 14)  
SHUFFLE button (pages 10, 11, 12, 14)  
PROGRAM button (pages 12, 19)
- 3 >10 (over 10) button (page 9)
- 4 REPEAT button (page 17)
- 5 ■ (stop) button (page 8)
- 6 ◀◀ ▶▶ (AMS\*) buttons (pages 9, 12, 19, 21, 24)
- 7 ◀◀ ▶▶ (manual search) buttons (pages 9, 18)
- 8 || (pause) button (page 8)
- 9 ▶ (play) button (page 8)
- 10 TIME button (page 8)
- 11 Numeric buttons (pages 9, 11, 14, 19, 21, 24)
- 12 M. SCAN button (page 15)

# Playing a Disc

Before playing a disc, turn on the amplifier and set the input selector to the CD player position.

## Inserting a Disc

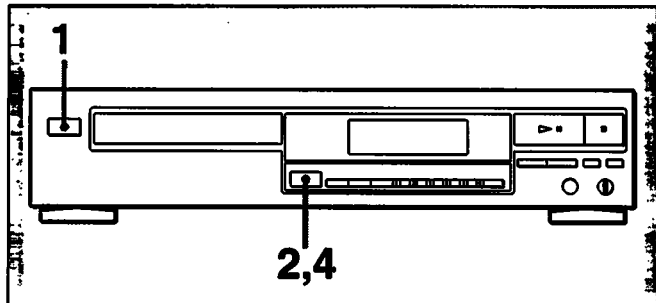

- 1** Press the **POWER** button.  
The display window is illuminated.



- 2** Press the **OPEN/CLOSE** button.  
The disc tray comes out.



- 3** Place a disc on the tray.

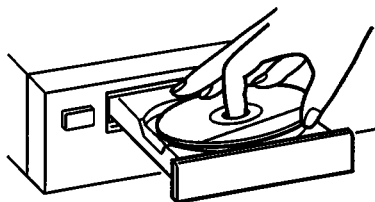

- 4** Close the tray.

The total playing time of the disc and total number of selections are displayed. The music calendar is also illuminated.

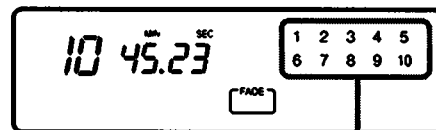

Music Calendar

### To take out the disc

Press the **OPEN/CLOSE** button.

### To play an 8cm (3-inch) CD

Place it on the inner circle of the tray. If the disc is provided with an adaptor, first remove it. Do not put a normal CD (12cm/5-inch) on an 8 cm CD.

### What is this indication?

*no disc*

This indication appears when there is no disc on the disc tray.

# Playing a Disc

## Playing the Entire Disc

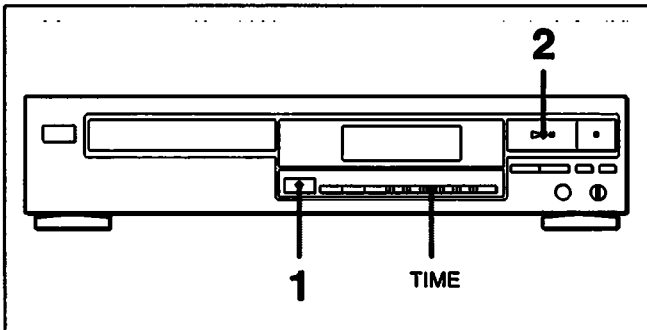

**1** Press the **▲ OPEN/CLOSE** button and place a disc on the tray.

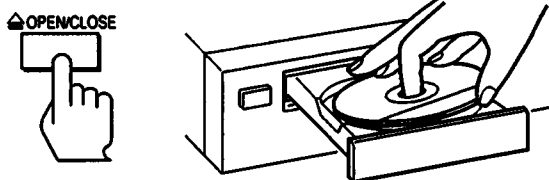

**2** Press the **▶|| (▶)** button.

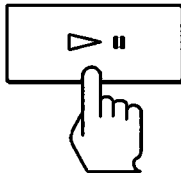

### To stop play

To stop for a moment during play, press the **▶|| (||)** button.

To resume play, press the **▶|| (▶ or ||)** button again.

To stop play, press the **■** button.

To stop play and open the tray, press the **▲ OPEN/CLOSE** button.

### For private listening

Connect a pair of headphones to the **PHONES** jack.

To increase the volume, turn the **PHONE LEVEL** control clockwise.

To decrease it, turn the control counterclockwise.

### Note on timer connection

When the power is turned on and a disc is in the CD player, connect the power cord of the player to timer.

When the preset time has arrived, playback starts automatically.

## Information Display

Each time you press the **TIME** button during play, the display changes to give you the following information.

a) Elapsed playing time

b) Remaining time in a selection

If the current selection number is over 20, "---.---" is displayed.

c) Remaining time of the disc

However, "---.---" is displayed instead of the actual time in the following cases.

- If a disc with more than 20 selections is being played in shuffle play or delete play mode.

- If any one selection the number of which is greater than 20 has been programmed.

- If the remaining time exceeds 100 minutes.

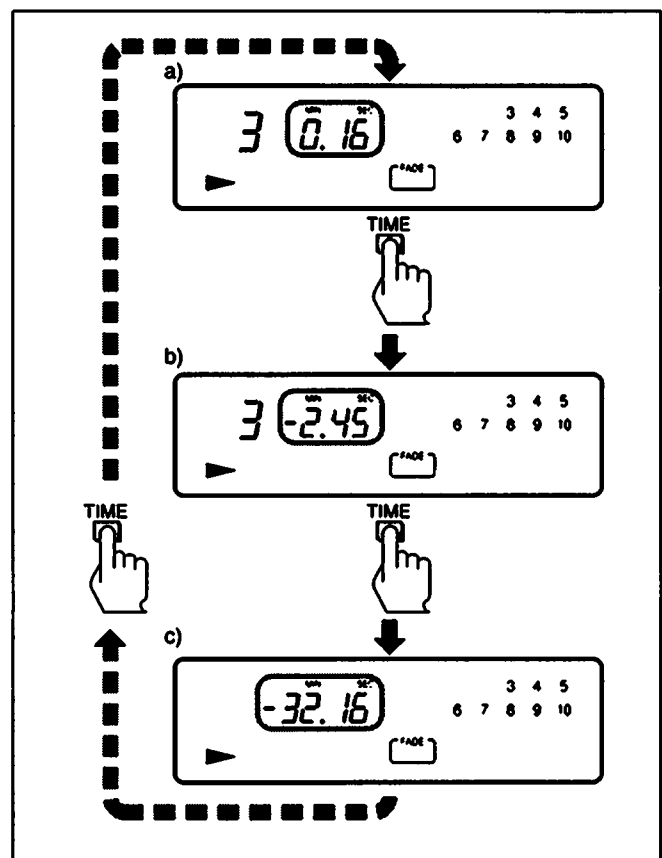

### Note

The time display mode selected with the **TIME** button will not change until the power is turned off.

### To check the total time and total number of selections

Press the **TIME** button in stop mode.

The total number of programmed selections will be displayed if a program is stored



## Locating a Particular Selection

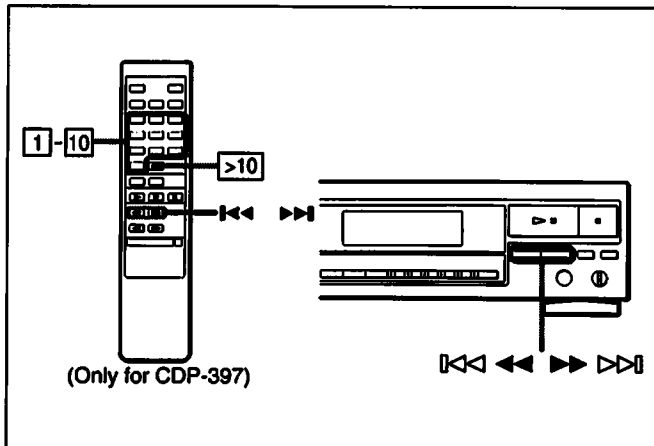

You can locate the beginning of a desired selection in two ways.

### a) To locate sequentially

To locate the beginning of the current or preceding selection

- Press the **I◀◀◀ (I◀◀)** button as many times as required.
- Keep the **I◀◀◀ (I◀◀)** button pressed to skip selections (operable only in stop mode when using the buttons on the main unit).

To locate the beginning of a succeeding selection

- Press the **▶▶▶ (▶▶)** button as many times as required.
- Keep the **▶▶▶ (▶▶)** button pressed to skip selections (operable only in stop mode when using the buttons on the main unit).

When you press the **I◀◀◀ (I◀◀)** button during play  
The unit locates the beginning of the selection.

### b) To locate directly with the remote commander (only for CDP-397)

Press one of the numeric buttons ( **1** to **10** ) to enter the desired selection number.

If a selection number is greater than 10, use the **>10** and **1** to **10** buttons. **10** functions as the figure 0.

e.g. To play from selection No.22

Press **>10** **2** **2**

e.g. To play from selection No.30

Press **>10** **3** **10**

## Locating a Particular Point in a Selection

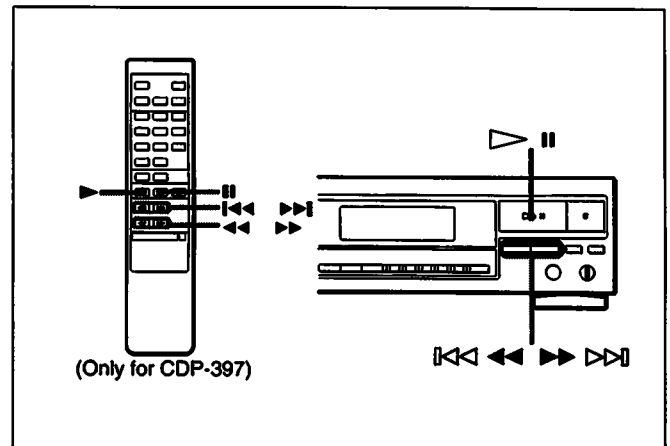

You can also locate a particular point in a disc during play in two ways.

### a) To search quickly while monitoring the sound

#### Forward locating at high speed

The **▶▶▶▶ (▶▶)** button pressed during play and release it at the desired point.

#### Reverse locating at high speed

Keep the **I◀◀◀ (◀◀)** button pressed during play and release it at the desired point.

### b) To search quickly by observing the display

Press the **▶▶▶▶ (▶▶)** button, then keep the **I◀◀◀ (◀◀)** or **▶▶▶▶ (▶▶)** button pressed. The search speed will increase, but there will be no sound. Find the desired point by observing the display.

Press the **▶▶▶▶ (▶▶ or ▶▶)** button again at the desired point.

#### When **rr** is displayed

If you continuously press the **▶▶▶▶ (▶▶)** button over the last selection, "**rr**" appears in the display. Press the **I◀◀◀ (I◀◀ or ◀◀)** button to return to normal indication.

# Playing Selections in a Random Order

You can have the selections played in a random order.  
The unit will play all the selections, or just the selections you prefer.

## Shuffle Play

The unit plays all the selections in a random order.

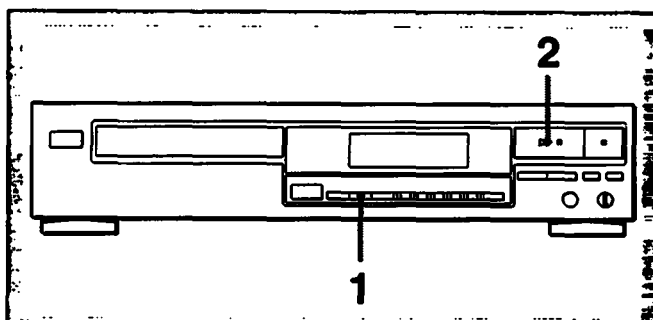

- 1 Press the SHUFFLE button.**  
"SHUFFLE" appears in the display.



- 2 Press the ►|| (►) button.**

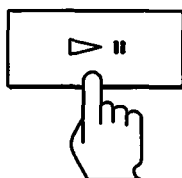

**To start shuffle play immediately from the current selection**

Press the SHUFFLE button during play and shuffle play begins from the current selection.

What is this indication?



This indication appears while the unit is "shuffling" the selections

### To cancel shuffle play

Press the CONTINUE button and the unit enters continuous play mode. "SHUFFLE" disappears from the display.

### To check the remaining time

Press the TIME button once to see the remaining time of the selection being played; twice to see the total remaining time; once more to return the initial display.

## Delete Shuffle Play

When you delete the undesired selections, the unit plays only the selections you prefer in shuffle play mode.

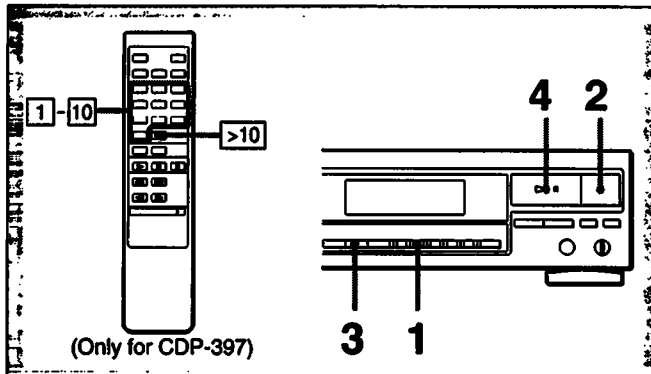

- 1 Press the CLEAR button while your undesired selections are being played.**  
Your undesired selections are deleted and "OFF" appears in the display, and the next selections are played soon.

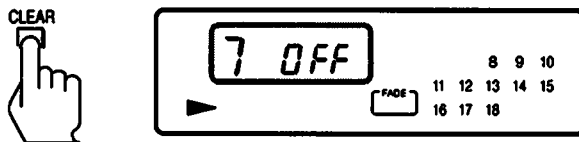

**To skip selections**  
Press the **⏮** (**⏮**) or **⏭** (**⏭**) button.

- 2 Press the ■ button after your undesired selections are deleted.**  
All the selection numbers that you have not deleted appear in the display.

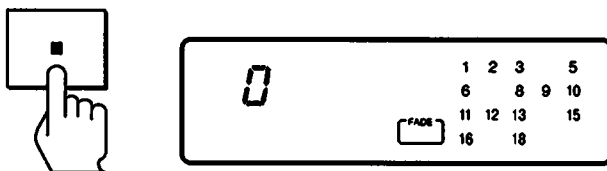

- 3 Press the SHUFFLE button.**  
"SHUFFLE" appears in the display.



- 4 Press the **▶||▶** (**▶**) button.**  
Delete shuffle play starts.

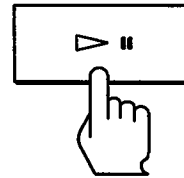

When using the remote commander (only for CDP-397)

- 1 Press the SHUFFLE button.**
- 2 Press the numeric buttons for your undesired selections.**  
Pressed numbers disappear from the display after "OFF" is indicated for a while.

**To restore a deleted selection while "SHUFFLE" is illuminated**

Press the numeric button for that selection. "On" will appear in the display.

**To choose a selection number over 10, see page 9.**

- 3 Press the **▶||▶** (**▶**) button.**  
Delete shuffle play starts.

**To delete a selection during play**

Press the numeric button for that selection.

"OFF" will appear in the display. You can also delete a selection being played by pressing the CLEAR button.

**To restore all the selections you have deleted**  
Press the **■** button in stop mode.

# Playing in a Desired Order

You can make a program by designating up to 24 selections in a desired order. The unit will play the disc according to your program. Concerning the method for recording a program, see page 19.

## Program Play

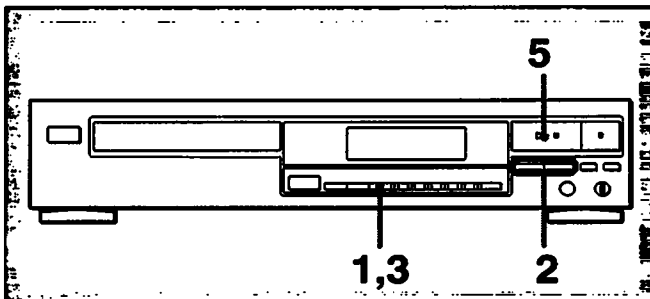

**1** Press the PROGRAM button.  
"PROGRAM" appears in the display.



**2** Press the <<<< (I<<<) or >>>> (I>>>) button to select your desired selections.  
The total playing time is displayed.

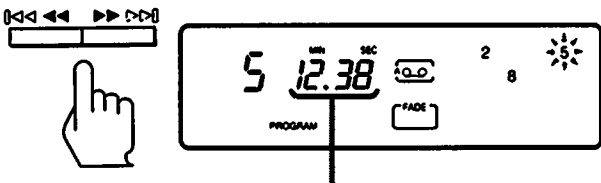

Total playing time

To select a selection number over 10, see page 9 (only for CDP-397).

**3** Press the PROGRAM button.

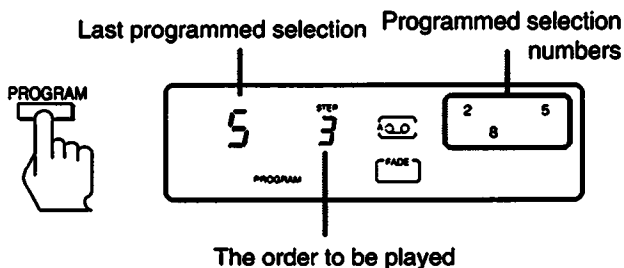

The order to be played

**If you choose wrong selections**  
Each time you press the CLEAR button, the last chosen selection is deleted.

**4.** Repeat Steps 2 and 3 to program other selections.

**5** Press the >>>> (I>>>) button.  
Program play starts.

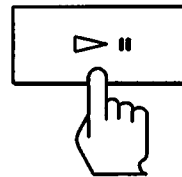

**To select your desired selections directly (only for CDP-397)**

Press the numeric buttons of the desired selections in desired order.  
To select a selection number over 10, see page 9.

**To stop playing**

Press the ■ button.  
When you press the >>>> (I>>>) button, you can play the same program repeatedly.

**To cancel program play**

Press the CONTINUE or SHUFFLE button and the unit enters continuous or shuffle play mode respectively. The program will be erased.

**If you press the PROGRAM button during play**

You can make a program. The selection being played will be the first one in the program.

**If the total playing time is not displayed while programming or if " - - - - " is displayed during play instead of the actual time**

- you have programmed a selection number over 20
- the remaining time exceeds 100 minutes.

## Checking and Changing the Program

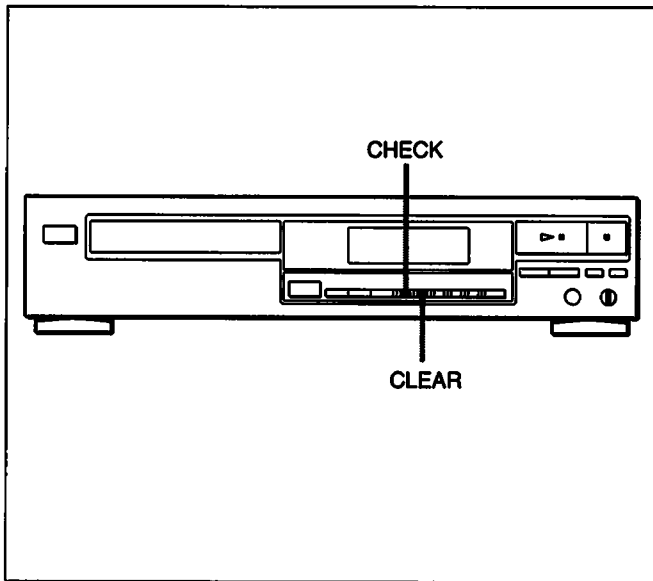

**To add a selection to the end of the program,** repeat the programming procedure from the beginning (or simply press the numeric button on the remote commander only for CDP-397).

**To delete a selection,** press the CHECK button repeatedly until the undesired selection is displayed. Then press the CLEAR button.



**To change the order,** press the ■ button in stop mode to erase the program. Then repeat the programming procedure from the beginning.

### **To check the remaining time**

Press the TIME button once to see the remaining time of the selection being played; twice to see the total remaining time; once more to return to the initial display.

If you have inserted a pause, the display shows the remaining time until the pause.

### **To check your program**

Press the CHECK button. The first selection in the program will be displayed.



Each time you press the CHECK button, the next selection in the program will be displayed. After the last selection, "End" will be indicated and the display will soon return to the initial status.

While checking the program for side A,  appears and for side B,  appears.

### **To change your program**

You can make the following changes before starting play.

**To erase the last selection,** press the CLEAR button. Each time you press the CLEAR button, the last selection in the program will be erased.

**To erase the entire program,** press the ■ button once in stop mode; twice during play.

The program is also erased when you turn off the unit or you press the ▲ OPEN/CLOSE button.

# Playing Only Desired Selections

You can delete undesired selections and play the remaining selections in the continuous play mode.

## Delete Play

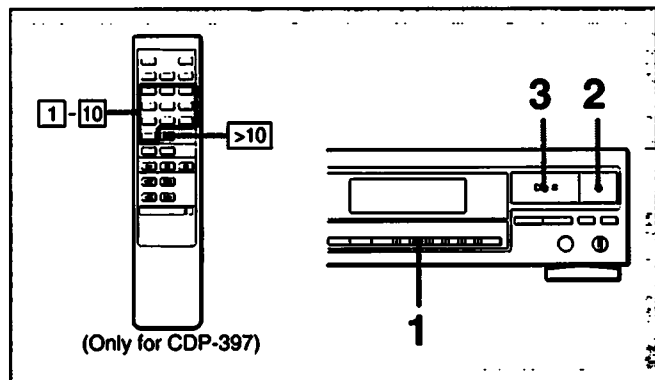

- 1 Press the CLEAR button while your undesired selections are being played.**  
Your undesired selections are deleted and "OFF" appears in the display, and the next selections are played soon.



**To skip selections**  
Press the >>>>I (>>>>I) or I<<<< (I<<<<) button.

- 2 Press the ■ button after your undesired selections are deleted.**  
All the selection numbers that you have not deleted appear in the display.

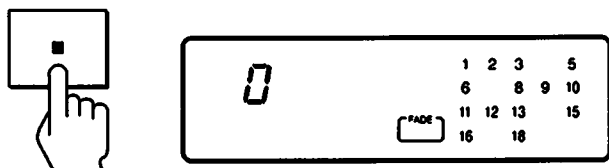

**To choose a selection number over 10 , see page 9 (only for CDP-397).**

- 3 Press the >|| (>||) button.**  
Only the remaining selections are played in the numerical order of the disc.

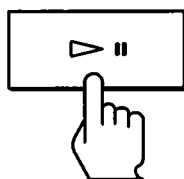

**When using the remote commander (only for CDP-397)**

You can delete selections directly. Delete your undesired selections in shuffle mode by pressing the numeric buttons (see page 11 for details), then press the CONTINUE button. "SHUFFLE" disappears from the display.

**To delete a selection during play**  
Press the CLEAR button while an undesired selection is being played. The next selection is played.

**To restore all the selections you have deleted**  
Press the ■ button in stop mode.

**When delete play ends**  
Selections except deleted ones will be restored.

Press the CONTINUE button,  
"SHUFFLE" disappears from the display

If you press the SHUFFLE button during delete play  
Selections will be played in delete shuffle play mode

# Playing the Beginning of Each Selection

You can play the beginning of each selection consecutively in any play mode. It is useful for checking the contents of a disc or program. You can choose the playing time of each selection from among 10, 20 and 30 seconds.

## Music Scan Play

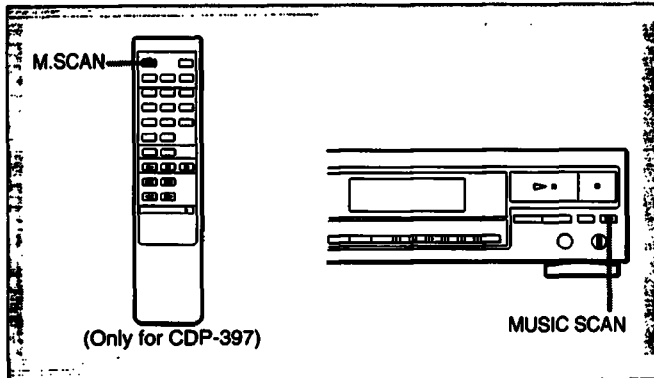

Press the MUSIC SCAN (M. SCAN) button in stop mode.

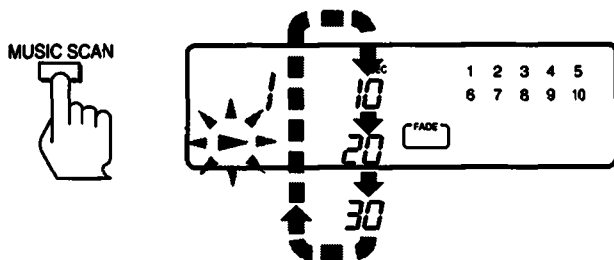

Each time you press the MUSIC SCAN button, the playing time of each selection changes cyclically from 10 to 30 seconds.

The ► indication in the display blinks and the beginning of each selection is played for the designated period.

### To start normal play immediately during scanning

Press the ►|| (►) button. The ► indicator in the display stops blinking.

### To change the designated playing time during scanning

Press the MUSIC SCAN (M.SCAN) button consecutively within 3 seconds until the desired playing time appears in the display.

If you keep the ◀◀◀ (◀◀) or ▶▶▶ (▶▶) button pressed Music scan play will be cancelled.

### Note

Whenever the unit is turned off, scanning time is reset to 10 seconds.

# Playing the Beginning of Each Selection

## Music Scan Delete Play

You can delete undesired selections while listening to the beginning of each selection either in continuous or shuffle play mode.

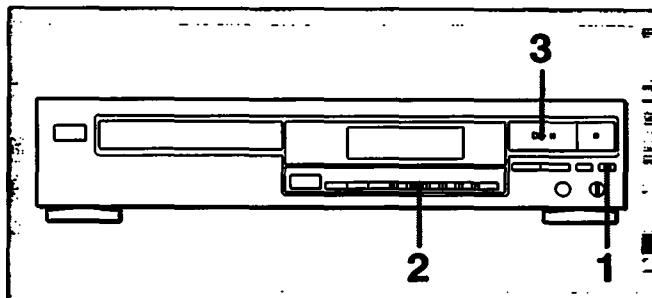

- 1 Press the **MUSIC SCAN (M. SCAN)** button in stop mode.



- 2 Press the **CLEAR** button at the beginning of an undesired selection.

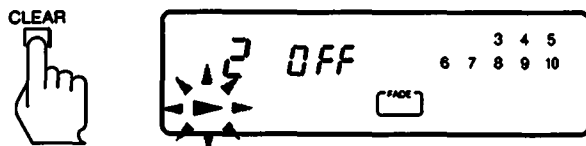

The number for the selection disappears from the display and the next selection is played soon. Repeat the procedure to delete other undesired selections.

**To skip the selection**  
Press **⏮** (⏮) or **⏭** (⏭) button.

- 3 Press the **▶|| (▶)** button to play the remaining selections after all the selections have been scanned.

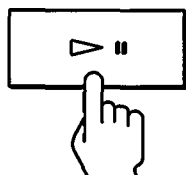

**To restore all the selections you have deleted**  
Press the **■** button in stop mode.

**When using the remote comander**  
(only for CDP-397)

**To restore a selection which you have deleted,**  
press the numeric button for that selection. "On" will appear in the display.



# Playing Repeatedly

You can choose between two different repeat play modes. One repeats all the selections in the current play mode, the other repeats any given selection either in continuous or delete play mode.

## Repeat Play

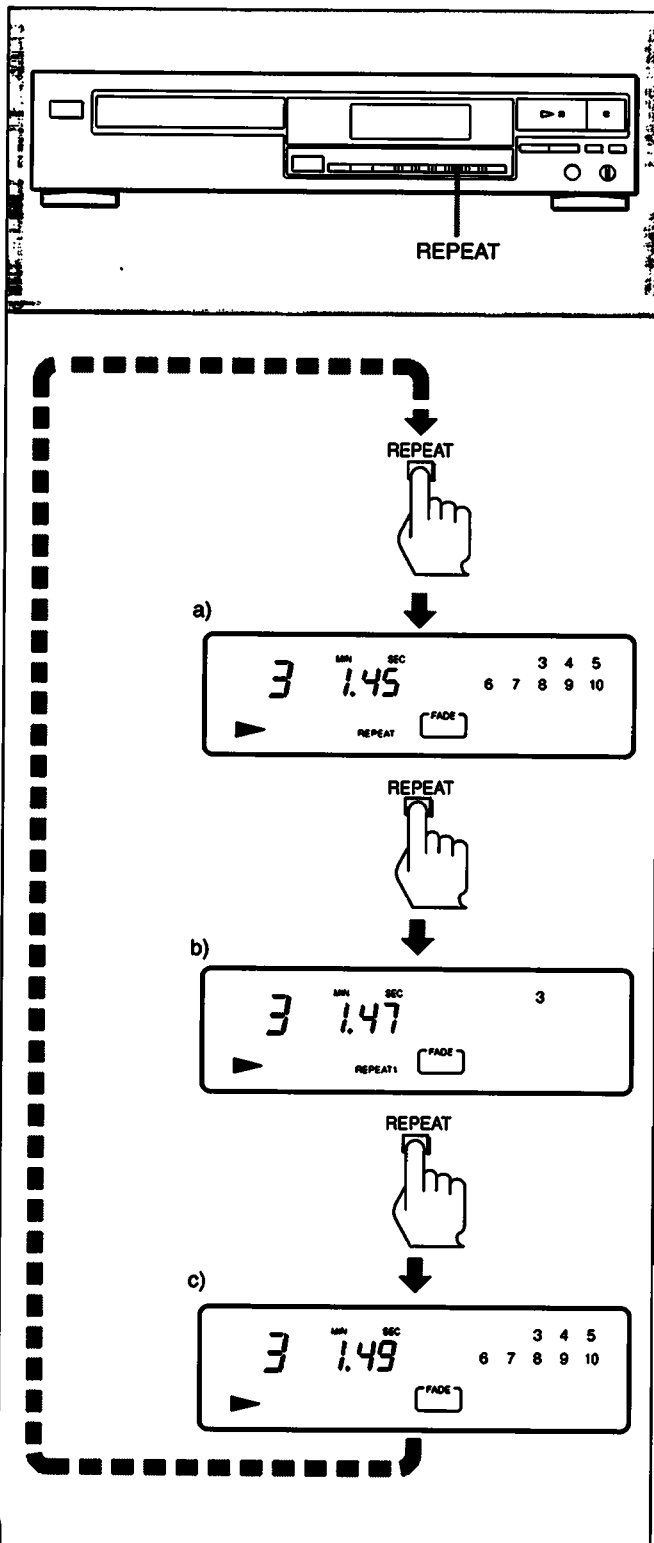

### To repeat all selections a)

Press the REPEAT button once. "REPEAT" appears. The unit will repeat in the current play mode.

Play mode	Selections to be played
Continuous play mode	All the selections
Program play	All the programmed selections in the same order
Shuffle play	All the selections that the unit reshuffles
Delete shuffle play	All the remaining selections that the unit reshuffles
Delete play	All the remaining selections

### To repeat the current playing selection b)

(only during continuous or delete play)  
Press the REPEAT button again. "REPEAT1" appears. (Not operable during shuffle, delete shuffle, or program play.)

### To cancel repeat play c)

Press the REPEAT button again. In continuous or delete play mode, "REPEAT 1" disappears. In any other play mode, "REPEAT" disappears.

# Fading In/Fading Out

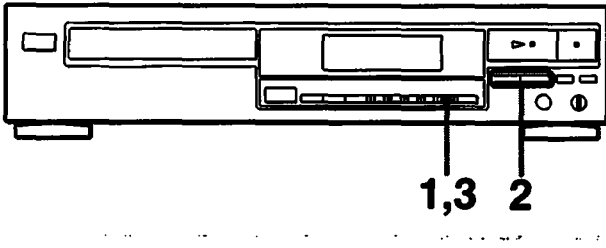

You can have the play fade in or out from 2 to 10 seconds.

## Designating the fading duration



**1** Press the FADER button in stop mode.



**2** Designate the fading duration within the range of 2 to 10 seconds by pressing the  or  button.

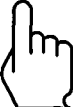

**3** Press the FADER button again.

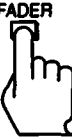

If no designation is made, fading will last for 5 seconds.

## Ending play fading out

Press the FADER button when you want to start fading out. "  " blinks in the display, and play fades out and the unit enters pause mode.

## Restarting play fading in

Press the FADER button in pause mode. "  " blinks in the display.

### Note:

Whenever the unit is turned off, the fading duration will be reset to 5 seconds

# Recording a Program (only for CDP-397)

You can make a program by designating up to 24 selections in desired order. At the same time, you can adjust the total playing time of the program, so that you can make the program fit the length of a tape when recording.

## Programming and Recording

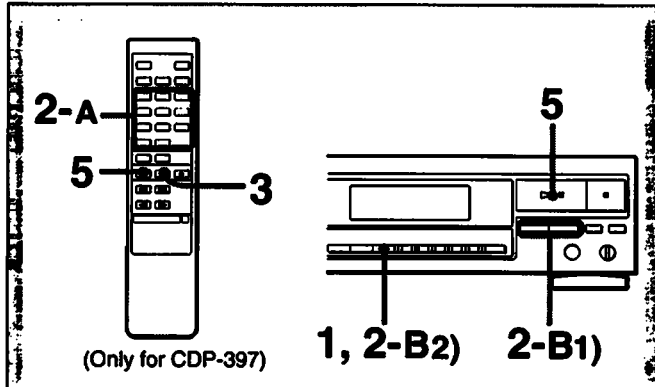

- 1** Press the **PROGRAM** button.  
"PROGRAM" appears in the display.



- 2-A**  
Press the numeric buttons of the desired selections in desired order (only on the remote commander).

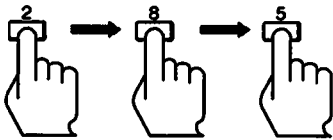

Last programmed selection

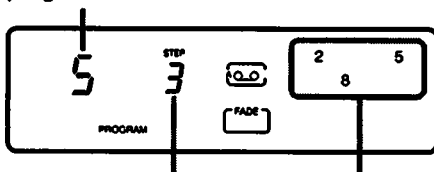

The order to be played      Programmed selection numbers

After one second, the total playing time is displayed.

To select a selection number over 10, see page 9.

**If you choose wrong selections**  
Each time you press the CLEAR button, the last chosen selection is deleted.

## 2-B

- 1) Press the **◀◀◀◀ (◀◀) or ▶▶▶▶ (▶▶)** button to change a selection and check the time. – Program edit

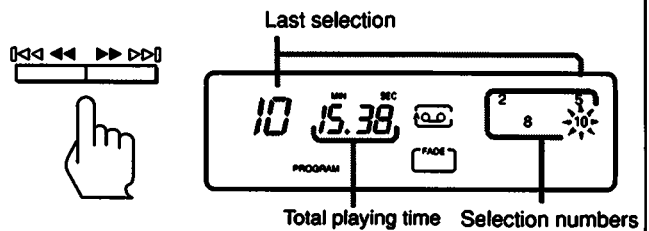

Total playing time of selections is displayed  
If satisfactory, go to the next step. If not, choose another selection.

- 2) Press the **PROGRAM** button to store the selection.  
Step number appears in the display for a while.

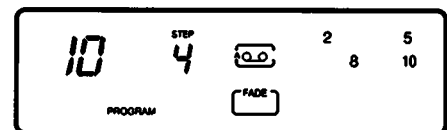

- 3) Repeat steps 1) and 2)

- 3** Press the **||** button on the remote commander to make a program for side B.  
"P" is displayed in the display and the total playing time is reset to 0. A pause is also counted as a selection.

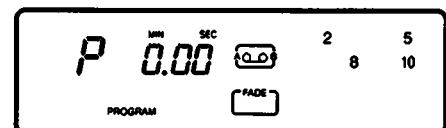
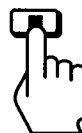

# Recording a Program (only for CDP-397)

(Only for CDP-397)

**4** Program selections for side B by repeating step 2-A or 2-B.

**5** Start recording on the cassette deck and press the ►|| (►) button.  
Be sure to start recording on the cassette deck first to transport the leader tape before pressing the ►|| (►) button on this unit.

**To make a program only for one side of a tape**  
Skip steps 3 and 4 in the prior procedure.

**To check the remaining time**  
Press the TIME button once to see the remaining time of the selection being played; twice to see the total remaining time: once more to return to the initial display.  
If you have inserted a pause, the display shows the remaining time until the pause.

**What is the tape indicator?**  
During program play, the tape indicator shows you which side of the program is being played.

: Program A is being played.

: Program A has been played and the unit is in pause mode, or program B is being played.

**To play the selections for side B**  
When the selections for side A are played, the unit enters pause mode. Reverse the tape, then press the ►|| (► or ||) button.

**To check your program**  
See page 13.

**To change your program**  
See page 13.

# Designating the Total Playing Time



You can designate a playing time and the unit will make 2 different programs of selections each fitting within that period.

These programs can contain up to a total of 24 selections.

Use this function, by designating the length of your tape, for editing both sides of a tape.

There are two types of editing: Time edit and just edit.

**Time edit** : sets the playing time of the each program within the designated time automatically, by choosing selections in numerical order which changes as little as possible

**Just edit** : sets the playing time of each program exactly (if impossible, approximately) with the designated time, by choosing selections without respect to numerical order.

You can also program desired selections by priority. In this case, you can designate desired selections beforehand and the remaining selections will be programmed to fit in the remaining time.

## Making a Program with Editing Functions

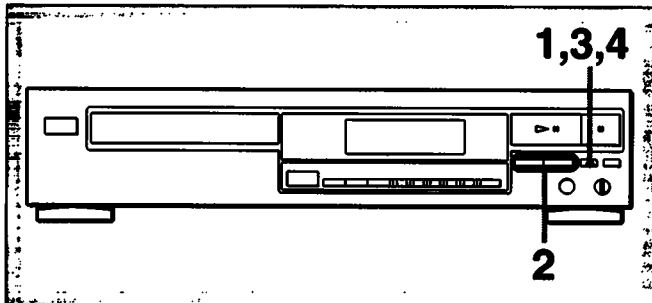

### 1 Press the EDIT/TIME FADE button.

EDIT/TIME FADE

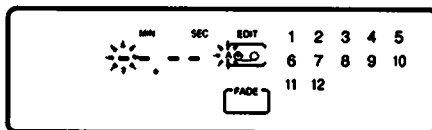

To choose time edit, press the EDIT/TIME FADE button once.

"EDIT" appears in the display.

To choose just edit, press the EDIT/TIME FADE button twice.

"EDIT" appears in the display and "JUST" is illuminated for a while.

### 2 Press the <<<< or >>>> to set the desired play duration.

Each time you press the <<<< or >>>> button, the display changes to give you the following durations:

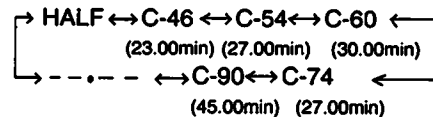
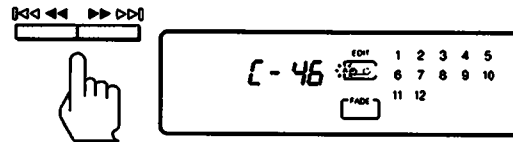

#### Note

- HALF cannot be set on a disc with more than 20 selections.

When you select HALF, the playing time of each program is set to a half of the total playing time of the disc.

However, programming for time edit and just edit are performed in different ways.

**Time edit** : divides all the selections of the disc into two programs without changing their order.

**Just edit** : programs selections by changing their order so that the length of each program becomes half the total playing time of the disc. However the program for side A will be a little longer than that of side B since the unit distributes all the selections.

#### When using the remote commander (only for CDP-397)

To set the time for one side of the tape as you want, press the numeric buttons.

Press **[0]** for "0".

You need not press buttons for the seconds, unless required.

# Designating the Total Playing Time

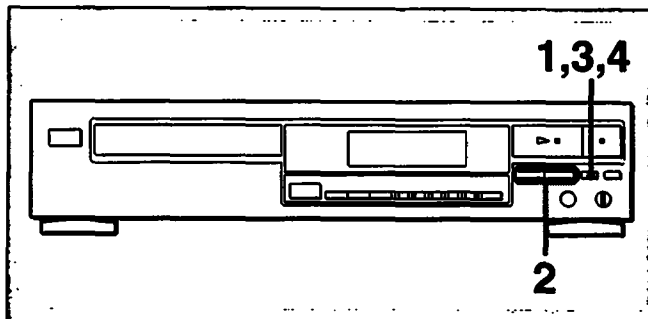

**3** Press the **EDIT/TIME FADE** button.  
The selections for side A are determined automatically.

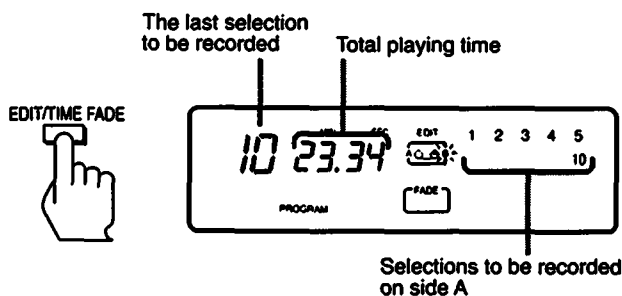

**4** Press the **EDIT/TIME FADE** button once more while "B" in the tape indicator is blinking.  
Another program for the other side is completed.

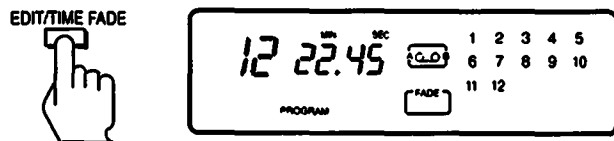

**If the unit takes time to carry out the just edit**  
There are many selections in the disc. In this case, press the **STOP** button. Programming procedure will be stopped at that time, but you can still have the program selected, the length of which is not your designated time but very close to it.

## Playing the Program

Press the **▶|| (▶)** button.  
The selections for side A will be played and then the unit will pause. Reverse the tape, then press the **▶|| (▶ or ||)** button again. The selections for side B will be played.

**To cancel the edit**  
Press the **CONTINUE** or **SHUFFLE** button and the unit enters continuous or shuffle play mode respectively. The program will be erased.

**To check the program**  
See page 13.

**When using the remote commander (only for CDP-397)**  
To designate a different time for each side, execute steps 1 to 3 on pages 19-20, then press **||**. Then execute steps 2 to 3 for the other side.

**If your disc has more than 20 selections**  
Selections over number 20 cannot be programmed with the time and the just edit function. Use the programming procedure on page 12.

# Locating the Portion with the Highest Volume — Peak Search



You can locate the portion with the highest input level of a disc to adjust the recording level.

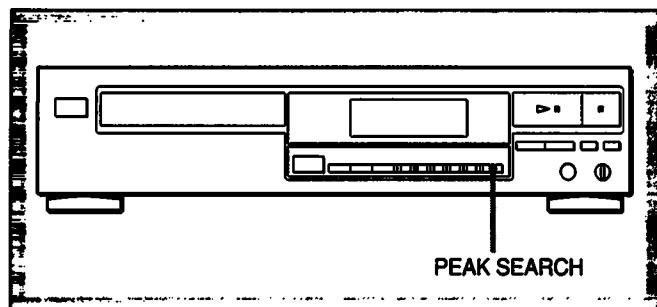

Before starting play, press the PEAK SEARCH button. "PEAK" blinks in the display as the peak search begins functioning.

Upon completing the search, the unit starts repeating the portion with the peak volume so that you can adjust the recording level.

## To cancel the peak search

- Press the ■ button. "PEAK" disappears from the display.
- Press the ►|| (II) button once to put the unit into pause mode at the beginning of the first selection.
- Press the ►|| button twice (or the ► button once) to start play from the first selection.

## On peak search

The unit scans input levels of the whole disc and determines the peak (maximum input level) among them. The peak determined with this function is sometimes slightly different from the real one. In addition, portions determined as a peak vary each time this function is carried out on the same disc. The difference between the determined and the real peak is however, negligible and will not prevent you from adjusting the recording level.

# Fading Out at the Desired Time — Time Fade



You can end the play fading out by designating the play duration. Once the time fade is set, it functions twice for editing both sides of a tape. You can change discs without cancelling this function and use it in any play mode.

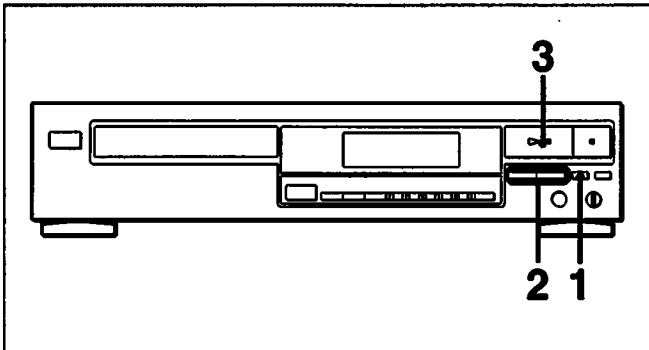

**1** Press the **EDIT/TIME FADE** button three times in stop mode, (or press it once in pause mode). "TIME FADE" and "A" in the tape indicator displayed in the display.



**2** Press the **◀◀◀** or **▶▶▶** to set the desired play duration.

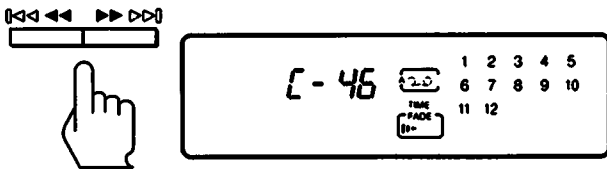

Each time you press the **◀◀◀** or **▶▶▶** button, the play duration for one side of the tape is displayed as follows.

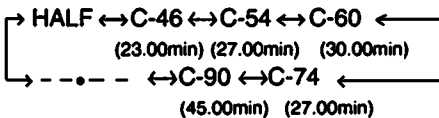

**When using the remote commander (only for CDP-397)**

To set the time for one side of the tape as you want, press the numeric buttons.

Press **10** for "0".

You need not press buttons for the seconds, unless required.

**3** Press the **▶|| (▶)** button to start playing.

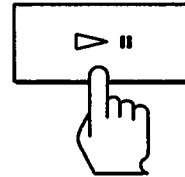

Before the unit enters pause mode at the set time with "B" illuminated in the tape indicator, play starts fading out for a specified duration (see page 18).

**To start play for the other side of the tape**

Press the **▶|| (▶ or ||)** button.

The unit enters pause mode at the set time by fading out for a specified duration.

When this play ends, time fade is cancelled.

**To cancel time fade**

Press the **EDIT/TIME FADE** button again.

Time fade is also cancelled when the **◀◀◀ (◀◀) or ▶▶▶ (▶▶)** button is kept pressed.

**To display the time remaining until the set time**

Press the **TIME** button twice.

**When play ends within the designated period**

Time fade function is kept active. Change discs and start play. When the total playing time of the discs reaches the designated period, the unit pauses by fading out.



# Maintenance

To keep the unit in good condition, clean the unit and discs periodically.

## Cleaning Your Unit

Clean the cabinet, panel and controls with a soft cloth lightly moistened with a mild detergent solution. Do not use any type of abrasive pad, scouring powder or solvent such as alcohol or benzene.

## Cleaning Discs

When a disc becomes dirty, clean it with a cleaning cloth. Wipe the disc from the center outwards.

Do not use solvents such as benzene, thinner, commercially available cleaners or anti-static spray intended for analog discs.

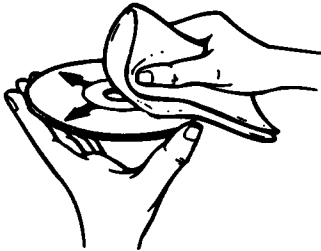

# Specifications

## Compact disc player

Laser	Semiconductor laser ( $\lambda=780$ nm) Emission duration: continuous
Laser output	Max. $44.6 \mu\text{W}^*$ * This output is the value measured at a distance of about 200 mm from the objective lens surface on the Optical Pick-up Block.
Frequency response	2 Hz to 20 kHz $\pm$ 0.5 dB
Signal-to-noise ratio	More than 100 dB
Dynamic range	More than 98 dB
Harmonic distortion	Less than 0.0045 %
Channel separation	More than 95 dB

## Outputs

LINE OUT (phono jacks)	Output level 2 V (at 50 kilohms) Load impedance over 10 kilohms
PHONES (stereo phone jack)	Output level max. 10 mW Load impedance 32 ohms

## General

Power requirements	120 V AC, 60 Hz
Power consumption	10 W
Dimensions (approx., including projections)	430 x 100 x 295 mm (w/h/d) (17 x 4 x 11 <sup>5</sup> / <sub>8</sub> inches)
Weight (approx.)	3.5 kg (7 lbs 12 oz)

## Remote commander (only for CDP-397)

Remote control system	Infrared control
Power requirements	3 VDC with two size AA (R6) batteries
Dimensions (approx., including projections)	40 x 20 x 175 mm (w/h/d) (1 <sup>5</sup> / <sub>8</sub> x 1 <sup>3</sup> / <sub>16</sub> x 7 inches)
Weight (approx.)	95 g (4 oz)

## Supplied accessories

Audio cord	(1) (2 phono plugs - 2 phono plugs)
Remote commander (only for CDP-397)	(1)
Sony SUM-3 (NS) batteries (only for CDP-397)	(2)

Design and specifications are subject to change without notice.

# Troubleshooting Guide

Before going through the check list below, first refer back to the connections and operating procedures.

Should any problem persist after you have made these checks, consult your nearest Sony service facility.

Symptom	Cause	Remedy
The disc tray does not close.	The disc is not placed correctly.	Place the disc correctly on the disc tray.
Play does not start.	Dirty disc.	Clean the disc.
	The disc is inserted upside down.	Insert the disc with the printed side up.
	II is engaged.	Press the ►II (►) button again to release it.
	Moisture condensation.	Leave the unit turned on for approximately one hour.
Sound is not heard.	Loose connection.	Insert the plug firmly.
	Connection is incorrect.	Check the connection referring to "Hooking Up the System".
	The PHONE LEVEL control is set to the minimum.	Turn the control clockwise.
Play does not begin from the first selection.	The unit is in the program or shuffle mode.	Press the CONTINUE button.
The remote commander does not operate the unit. (only for CDP-397)	The batteries are run down.	Replace both batteries.
	The remote commander is not pointed at the remote sensor.	Point the remote commander at the sensor.
	There is an obstacle between the remote commander and the unit.	Remove the obstacle.
	The remote commander is too far from the unit.	Move closer.