

# FM STEREO/FM-AM RECEIVER

*Quemets Electronics*  
*May 27, 1972*

## STR-6065

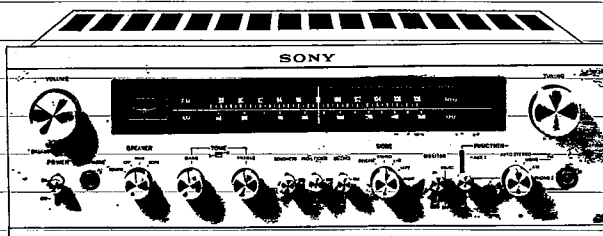

**OWNER'S INSTRUCTION MANUAL**

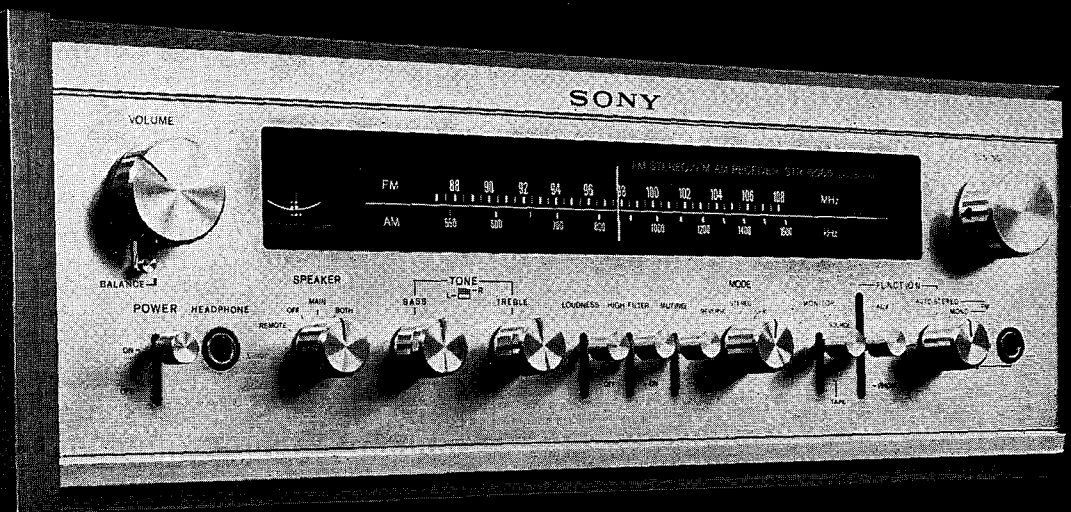

Welcome to the world of finest stereo reproduction. The STR-6065 consists of excellent fm and a-m tuners, a clear preamplifier and a powerful output amplifier in one complete package. Off-the-air fm stereo and a-m programs, records, tapes, or any other program sources can be channelled through the STR-6065. Speaker terminals for main and remote speaker systems, and the additional center-channel output allow for the future expansion of your stereo system.

In the fm tuner section the FET front end raises the sensitivity to its theoretical limit while retaining the ability to handle strong local stations without overload and spurious response. Solid state filters in the i-f section replace conventional tuned i-f transformers for exceptional selectivity and long-term stability. Station on nearby channels do not break through into the program you're listening to. The receiver never needs realignment.

In the a-m section, the STR-6065 also provides high sensitivity with superior signal-to-noise ratio, and its linearity and dynamic range assure low distortion. This remarkable improvement of a-m sound is the result of the FET input circuit and solid state i-f filters.

Precision tuning is easy with the long, linear scale and accurate tuning meter.

An effective muting circuit silences all interstation noise as you tune from station to station. This protects the speakers and further simplifies tuning.

The amplifier section has all the power needed to provide any speaker system with plenty of reserve for difficult passages. It reproduces the entire audio range without permitting the slightest trace of distortion to intrude upon the performance.

The connection and the operation of the STR-6065 is quite simple, yet provides considerable versatility. Please take the time to read completely through this manual, so that you can become familiar with the STR-6065's features and capabilities. Keep this manual handy for future reference.

## TABLE OF CONTENTS

WARRANTY.....	1
PREPARING FOR USE .....	2
Unpacking.....	2
System Connections.....	2
Antennas	
Speakers	
Input connections	
Headphones	
GROUND connection	
Power connection	
How to Use the Center Channel Output.....	7
Custom Mounting .....	8
TAC-5E cabinet	
Panel mounting	
OPERATING INSTRUCTIONS .....	8
Function and Location of Controls and Connectors .....	8
How to Use Your STR-6065 for FM or AM Reception.....	11
How to Use Your STR-6065 with a Record Player .....	11
How to Use Your STR-6065 with a Tape Recorder .....	11
Balancing the Stereo System .....	12
Stereo balance	
Speaker phasing check	
CARE OF YOUR EQUIPMENT .....	12
Cleaning .....	12
Trouble Checks .....	12
TECHNICAL DATA.....	13
Technical Specifications .....	13
Block Diagram .....	14
REPACKING FOR SHIPMENT .....	16

### WARRANTY

An application for the free 3-year factory service warranty is included with the STR-6065. Fill in the application and mail it within 10 days of the date of purchase.

## PREPARING FOR USE

### UNPACKING

All SONY equipment comes to you carefully packed in cartons designed to withstand the rigors of shipment. Do not throw the carton or associated packing material away; they will come in handy if you ever have to transport or ship the STR-6065.

Inspect your STR-6065 immediately for signs of damage incurred in transit. If damage has occurred, consult your local SONY dealer for further instructions. Once again, save all packing material; it will substantiate your damage claim.

### SYSTEM CONNECTIONS

No doubt you have already decided on a location for your STR-6065. However, before going ahead with the installation, make sure that your choice of location agrees with the following list of DO's and DON'T's.

- DO** allow at least 1 inch clearance around the STR-6065 for ventilation.
- DO** allow sufficient room behind the STR-6065 so you can make connections to the rear panel without disrupting your entire setup.
- DON'T** remove the chassis cover. Refer servicing to qualified personnel.
- DON'T** place the STR-6065 in direct sunlight, or near radiators, hot-air ducts, or any other source of heat. Similarly, don't place it in any area subject to freezing temperatures or excessive moisture.
- DON'T** place the STR-6065 on any soft surface which may block the bottom ventilation holes.
- DON'T** connect the STR-6065 to power sources other than those for which it is designed. The proper power source is 117 volts, 60 Hz (cycles) ac. Do not operate the receiver where the line voltage is over 128 volts.
- DON'T** make connections with the POWER switch turned ON.

After you have found a suitable location for your STR-6065, you can begin making the basic connections described in the following paragraphs. Refer to the overall-system connection diagram while making these connections.

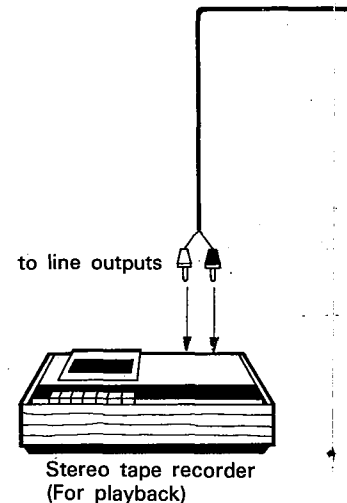
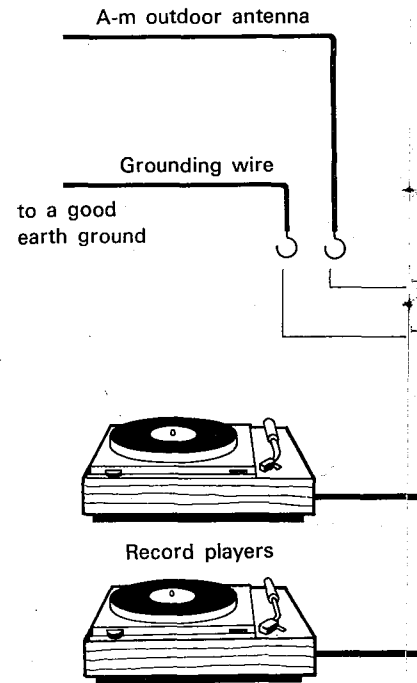

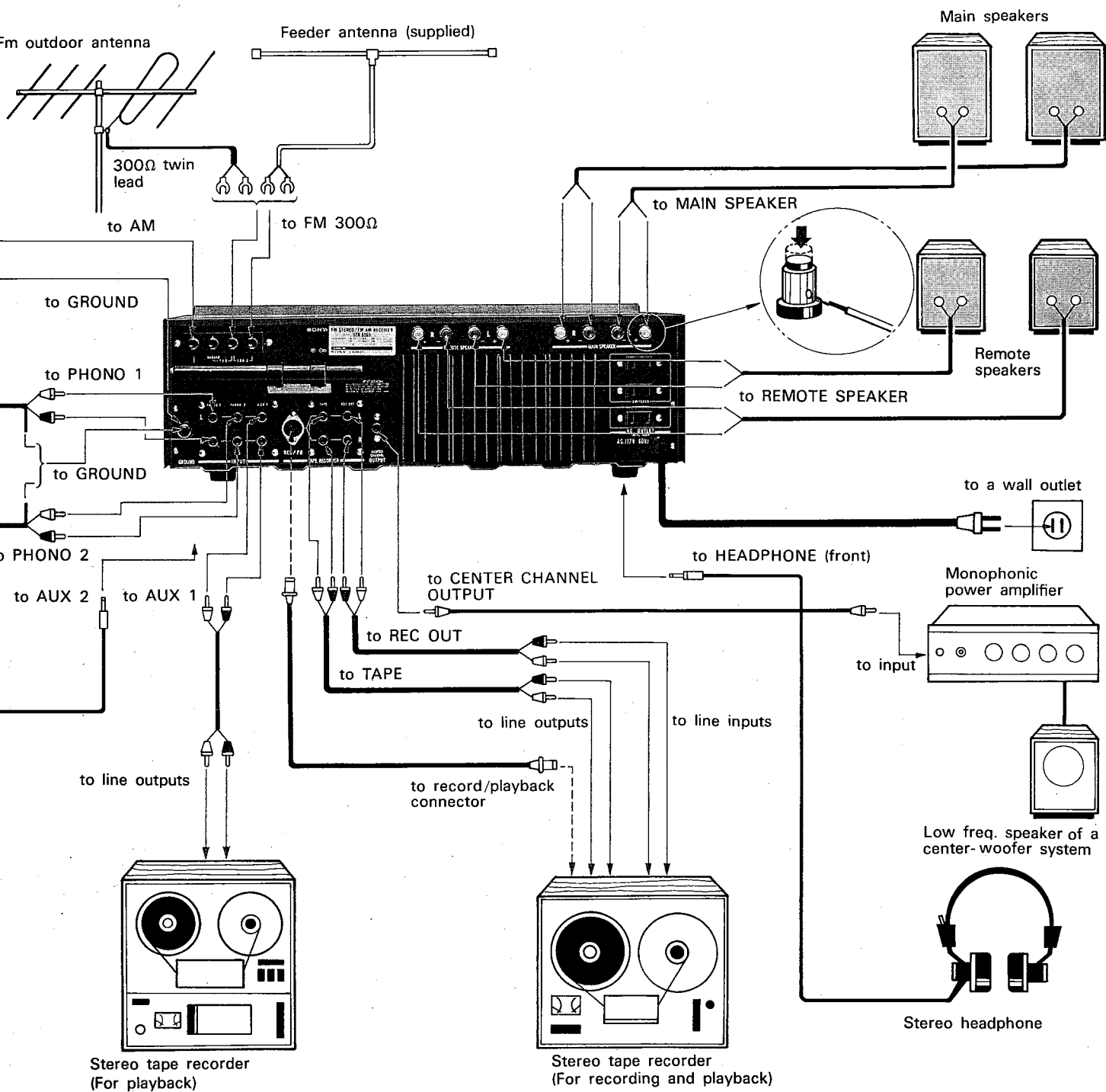

## Antennas

The sensitivity of the STR-6065 is so great that in most areas it will work well with simple antennas such as the ribbon dipole antenna. However, for the very best fm reception possible, particularly at problem locations, a more elaborate antenna may be necessary.

The factors determining the minimum antenna requirements for your location include the following:

1. How strong are the fm signals in your neighborhood?
2. Are all the fm stations in the same direction, or are they scattered all over?
3. Is multipath reception a problem?

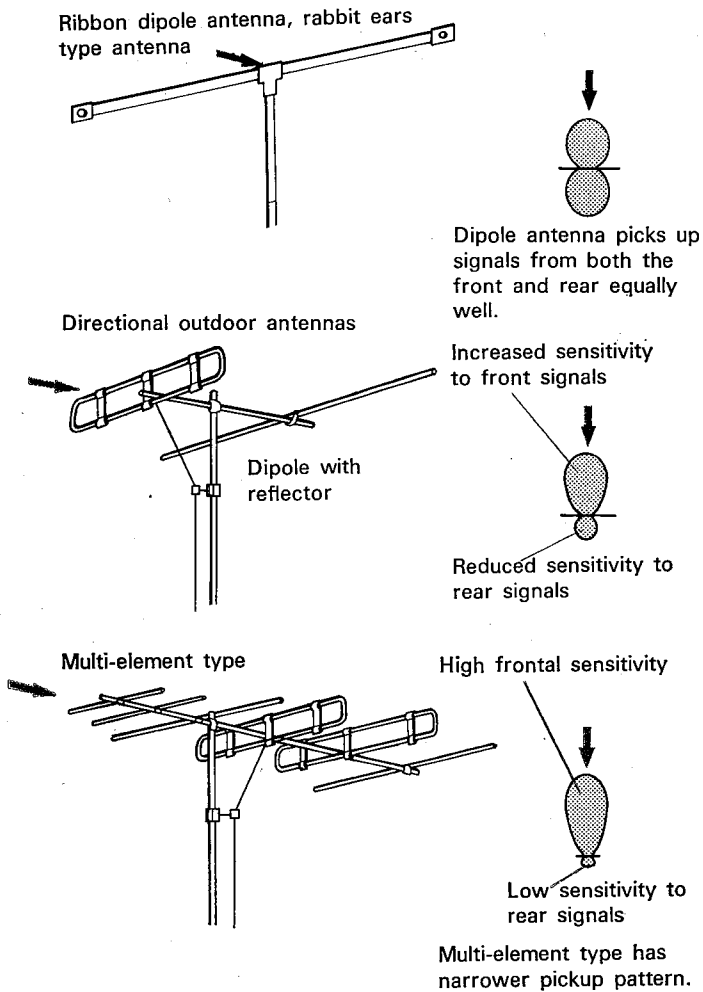

As far as signal strength is concerned, many city dwellers do extremely well using just a ribbon-type fm dipole or the familiar "rabbit ears." The rabbit-ear antenna is the more preferable of the two since it can easily be rotated and otherwise adjusted for best reception. However, in the far suburbs, a high-gain highly-directive outdoor fm antenna is necessary to secure the best signal-to-noise ratio on stereo broadcasts.

Omnidirectional antennas are quite handy if the local fm stations lie in different directions and you don't want to use a rotator. However, if "fm ghosts" (multipath reception) cause the problems described in the next paragraph, you must use a highly-directive antenna and rotator, or several highly-directive fixed antennas.

**Multipath Reception** Good fm reception depends not only on the sensitivity of the receiver but on the quality of the received signal. The most important factor affecting signal quality is "multipath" reception. Multipath reception is the arrival of a signal at an antenna from several points, the result of signal reflections from tall buildings or bridges, just to cite a few examples. These signals arrive at the antenna at different times, depending upon the lengths of the paths they travel. The addition of these signals at the receiver can produce audible distortion and loss of channel separation. Multipath reception is a condition that depends solely upon the terrain of the surrounding locality.

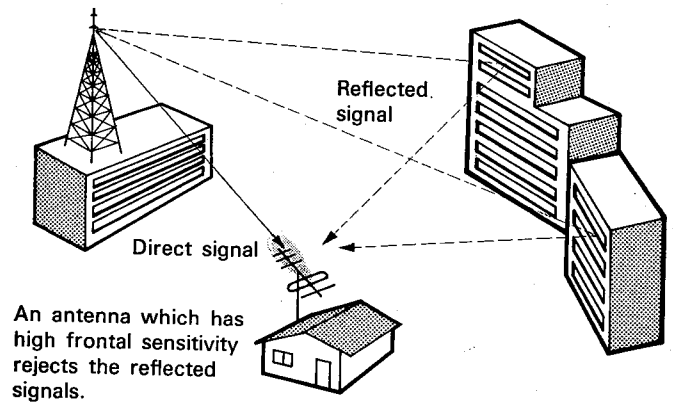

**Connecting the FM Antenna Lead** The STR-6065 accepts either 300-ohm transmission line (twin lead) or 75-ohm coaxial cable. The 300-ohm twin lead may be either the standard or shielded type. Standard 300-ohm twin lead is inexpensive and will be perfectly adequate for most installations. However, in cases where local noise or multipath pickup on the transmission line causes interference, a shielded transmission line must be used. Coaxial cable and a matching transformer can be used, but 300-ohm shielded twin lead is preferable because most fm antennas are designed to directly match a 300-ohm impedance line.

To connect standard 300-ohm twin lead to the STR-6065, loosen the ANTENNA terminals marked FM 300Ω. Strip the plastic insulation from the two-conductor lead-in wire and wrap each conductor around a terminal. Tighten the terminals.

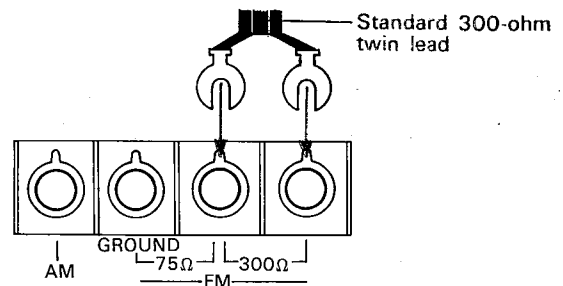

To connect shielded 300-ohm twin lead to the STR-6065, connect the two conductors as described before, then connect the shield drain wire to the GROUND terminal on the antenna terminal plate.

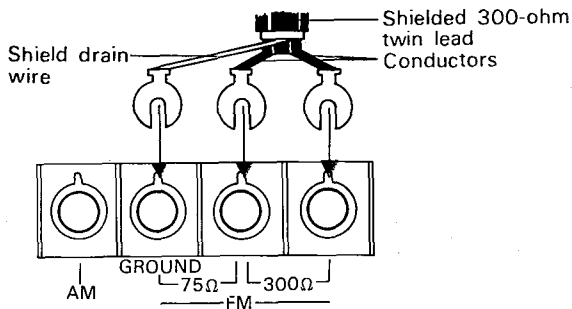

To connect 75-ohm coaxial cable to the STR-6065, strip the insulation from the cable and separate the center conductor from the outer braid. Connect the center conductor to the center terminal of the FM ANTENNA, and the braid to the GROUND terminal on the antenna terminal plate.

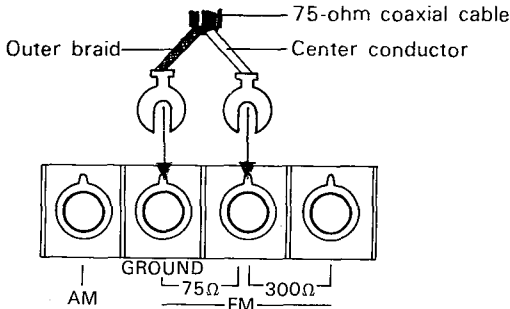

**Antenna Orientation** The signal strength of fm stations are indicated on the Tuning Meter. First, tune in the desired station by adjusting the TUNING knob for a center-channel indication, then adjust the antenna direction and height for clearest sound. The signal strength is indicated by the amount of deflection of the meter pointed from the center position when the receiver is detuned from the station by turning the TUNING knob. The stronger the signal, the greater the deflection.

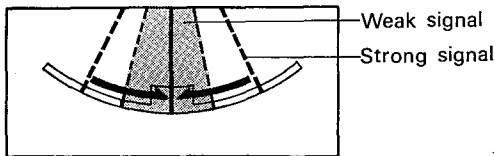

- If distortion is audible, adjust the direction and/or height of the antenna until the distortion is eliminated. Often, a slight turn will be sufficient.
- In some cases multipath reception on two or more stations may require the antenna to be pointed in several different directions. An effective and relatively inexpensive solution to this problem is the use of a remote-controlled antenna rotator.
- Keep the antenna lead-in wire as short as possible and avoid long horizontal runs to minimize signal pickup on the line. The use of shielded cable is recommended in multipath areas.
- If an outdoor antenna cannot be erected, use a good indoor antenna ("rabbit ears" are satisfactory). Adjust the antenna for minimum distortion by listening to the quality of the sound.

**A-m Reception** Pull down the built-in bar antenna located at the rear of the set. In most cases, this ferrite-bar antenna will provide optimum a-m reception. In difficult reception areas an outdoor antenna will be helpful. Connect a length of wire, at least 16 feet long, to the AM ANTENNA terminal.

The signal strength of a-m stations is indicated on the Tuning Meter; the stronger the signal, the greater the deflection toward the right.

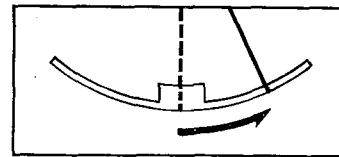
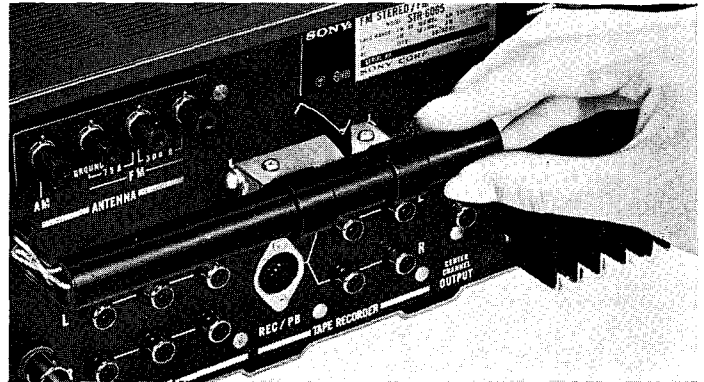

For a-m reception

## Speakers

The STR-6065 can drive two speaker systems, main and remote, simultaneously or independently. Both systems are turned on or off with the SPEAKER selector on the front panel. The speakers connected to these terminals should have an impedance of 4-16 ohms if one set of speakers is used; and 8-16 ohms if two sets are used.

**Location** In many home-entertainment stereo systems, the choice of speaker location is often limited by the existing furniture arrangement. However, if rearrangement is possible, or you wish to furnish the area specifically for stereo listening, here are a few suggestions for optimizing your listening pleasure.

Set up your speakers in a large room having a rug on the floor. If the room has heavy drapery, so much the better. Rugs, drapery, and upholstered furniture minimize the multiple reflections of high-frequency sound that occur in a bare room and which degrade the stereo effect.

The usual speaker location is on the floor against a wall. If you must position the speakers off the ground, do not put them higher than eye-level. Because of psychological conditioning, sound coming from the vicinity of the ceiling gives an unnatural feeling. Corner locations, however, are ideal for emphasizing the bass notes.

The distance between the right and left-channel speaker system in a stereo system is important to the stereo effect. Closely-spaced speakers produce minimum stereo effect. Widely-separated speakers produce maximum stereo effect, although if the separation is too great, the unnatural "hole-in-the-middle" effect

appears. The proper distance between speakers is directly related to the distance from the speakers to the listening areas. In most cases, fine results are obtained if the speakers are separated by an amount slightly more than the distance from the listening area to each speaker. In any case, experiment with different speaker and listening locations until you find the setup that pleases you most.

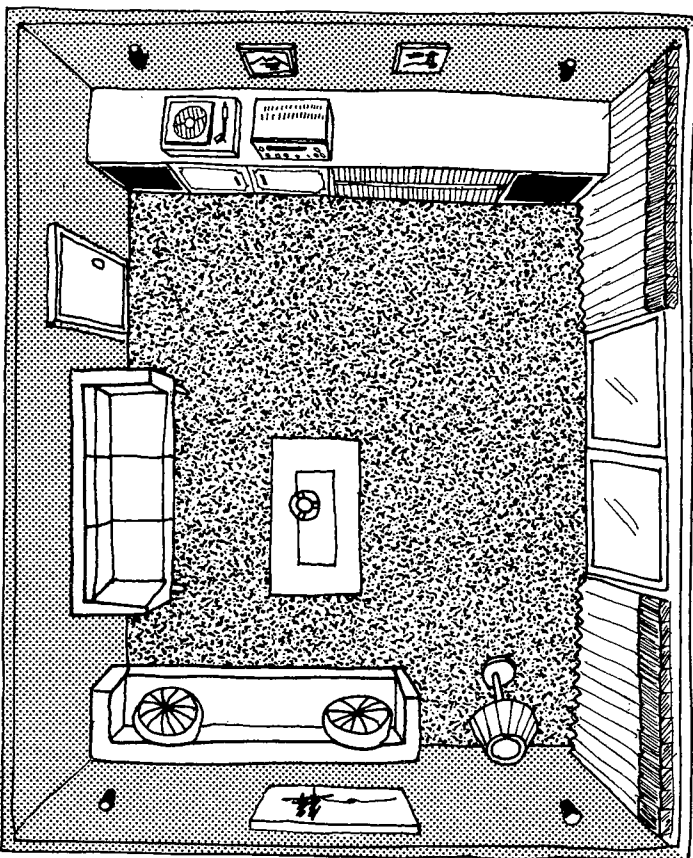

**Cable Type** The type of wire used to connect the speakers to the receiver is not critical in most home stereo systems. Ordinary dual conductor lamp cord is often used for this purpose. Common 18 gauge lamp cord is fine for distances of under 35 feet. However, 14 to 16 gauge wire may be needed for long runs to low-impedance speakers to prevent excessive power losses in the wiring. If you use lamp cord or any other stranded wire, make sure that none of the strands separates from its group and shorts across the speaker or receiver terminals.

**Connection** Connect your speaker system to the MAIN SPEAKER terminals. Connect the right and left speakers to the RIGHT and LEFT speaker terminals respectively. To properly phase the speakers, make the connections so that the positive (+) terminal of the speaker connects to the positive (+) terminal of the STR-6065, and the remaining lead of the cord connects the negative (-) terminals on the speaker and the receiver. This is easy to do if one of the wires in a lamp cord pair is coded. Most lamp cord is coded by means of a ridge molded along one conductor, or a colored thread included with the stranded wires of one conductor. If you are also using remote speakers, connect them to the REMOTE SPEAKER terminals as described above.

## Input connections

For input connections, use low-capacitance shielded cable. Keep the cables as short as possible.

When reconnection is required, turn the VOLUME control counterclockwise.

To use the supplied pin plug, see the illustrations below.

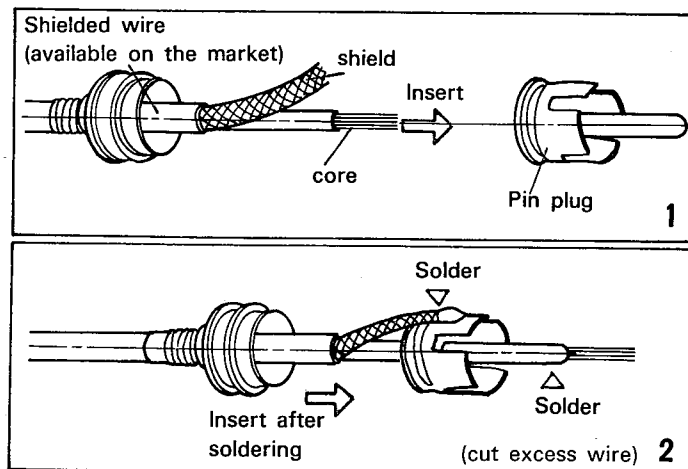

**Record Players** Connect a record player equipped with a magnetic cartridge to the PHONO 1 or PHONO 2 input.

Hum heard during phono operation is usually the result of poor or incorrect grounds between the tone arm and the amplifier. If hum is heard, connect a ground wire between the turntable base and the GROUND terminal on the STR-6065. Try reversing the ac line cord. Check your turntable. If the tone arm is mounted on a wooden surface, it may be necessary to make a ground connection between the base of the tone arm and the STR-6065.

**Tape Recorders** Connect the "line (AUX) inputs" of the tape recorder to the REC OUT jacks on the rear panel of the STR-6065. Connect the "playback" outputs of the recorder to the TAPE (or AUX 1 or 2) inputs of the STR-6065.

If your tape recorder or tape deck uses the same type REC/PB connector as that on the STR-6065, the record/playback connections can be made with a single REC/PB connector cable. In this case, do not connect any input source to the TAPE inputs.

**Use of the AUX 1, AUX 2 Input Connectors** These inputs have been provided for connecting various program sources such as a tape recorder, additional tuner, record player equipped with a ceramic or crystal cartridge, etc.

**AUX 1** (on the rear panel): Convenient to connect input sources for permanent use.

**AUX 2** (binaural input on the front panel): Convenient to connect an input source for temporary use. For this connection, the SONY RK-81 Connecting Cord is recommended.

• For connection through the AUX 2 jack or HEADPHONE jack, make the connecting cord by using the supplied binaural plug, a shielded cable and plugs matched to your equipment (both are available on the market).



Solder the parts marked (▷) securely as illustrated.

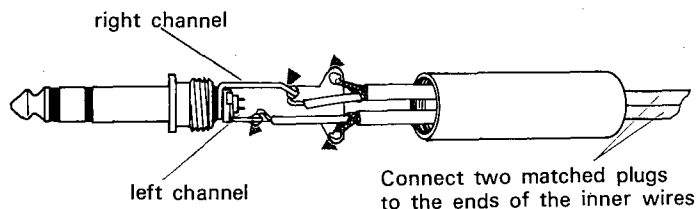

The optional accessory RK-81 Connecting Cord (one end equipped with a binaural plug and the other end with two pin plugs) is recommended for your convenience.

### Headphones

Connect headphones of greater than 8 ohms impedance, equipped with a standard phone plug, to the HEADPHONE jack on the front panel. The headphone output is not affected by the position of the SPEAKER selector on the front panel.

This jack can also be used as a temporary output connector for tape recording. In this case, the output level can be adjusted by the use of the controls on the STR-6065. For this connection, the SONY RK-81 Connecting Cord is recommended.

### GROUND Connection

Connect the ground wire from the record player to the GROUND terminal of the STR-6065. If hum occurs, connect the GROUND terminal to a convenient earth ground, such as the mounting screw of an ac outlet cover plate. A more direct earth ground (preferably a cold-water pipe) is recommended for lightning protection when an external antenna is used.

### Power Connection

Before making any form of power connection, make sure the POWER switch is set to OFF. Then plug the STR-6065's line cord into a convenient electrical outlet providing 117 volts, 60 Hz (cycles) ac. Female outlets on the rear panel provide switched and unswitched sources of up to 300 watts ac power for any of your other system components.

## HOW TO USE THE CENTER CHANNEL OUTPUT

Stereo sound systems are sometimes characterized by an apparent lack of lows. The stereo effect relies upon mid- and high-frequencies because human hearing is quite directional in this range. However, low-frequency sounds, below 200 Hz, produce no directional sensation at all. Therefore, you can reinforce lows with a monophonic channel that carries mixed low-frequency signals. The use of the CENTER CHANNEL OUTPUT preserves the stereo effect because musical sounds are composed of fundamental frequencies and harmonic multiples of those fundamentals. When a low-frequency note is reproduced, the intensity of the fundamental note is provided by the center-channel speaker, but the harmonics are produced in the left and right speakers. Thus, low-frequency volume is augmented, but the apparent directional response is retained.

In systems using CENTER CHANNEL OUTPUT, the left and right speakers should be placed with the usual care required for good stereo effect. However, the center-channel speaker, since its output is nondirectional, can be placed in any convenient location. The illustration below shows the basic arrangement of a center-woofer system. Note that the low pass filter is employed between the receiver and the monophonic power amplifier. The filter eliminates high-frequency signals in the feed to the center-channel woofer. The high pass filters reduce low-frequency signals in the feed to the full-range speakers.

This system delivers more effective sound reproduction with less overall distortion, because harmonic and IM distortion can be avoided in the full-range speakers, even if these speakers are rather small.

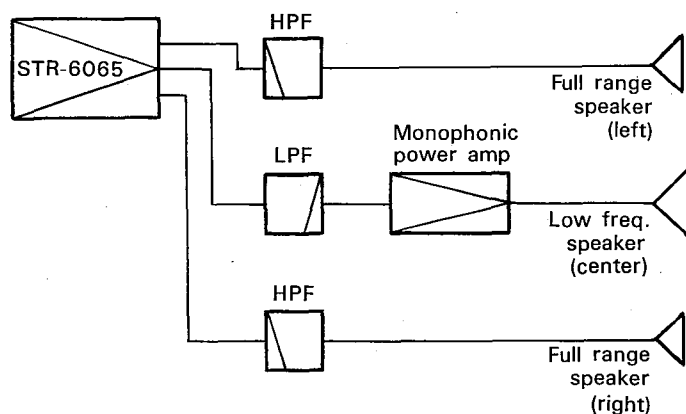

## CUSTOM MOUNTING

### TAC-5E Cabinet

An attractive oiled walnut case, the TAC-5E, is available as an optional accessory.

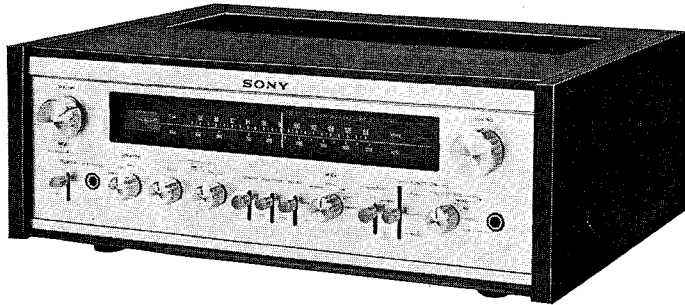

### Panel Mounting

If the STR-6065 is to be mounted in a custom-built panel, the opening in the panel should conform to the dimensions given in the following illustration.

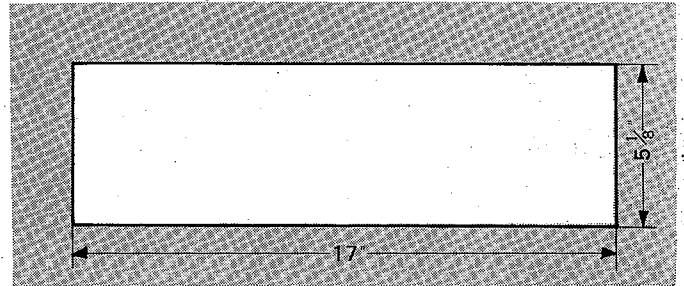

Although the STR-6065 dissipates little heat, make sure that the cabinet is adequately ventilated, and that the ventilation holes on the STR-6065 are not blocked. Avoid installation in locations subjected to excessive dust or moisture.

## OPERATING INSTRUCTIONS

### FUNCTION AND LOCATION OF CONTROLS AND CONNECTORS

Before attempting to operate your STR-6065, take a few minutes to learn the function and location of the controls, connectors, and other parts mentioned in the operating instructions. The locations are shown in the illustration, and the functions are described on pages 9 and 10.

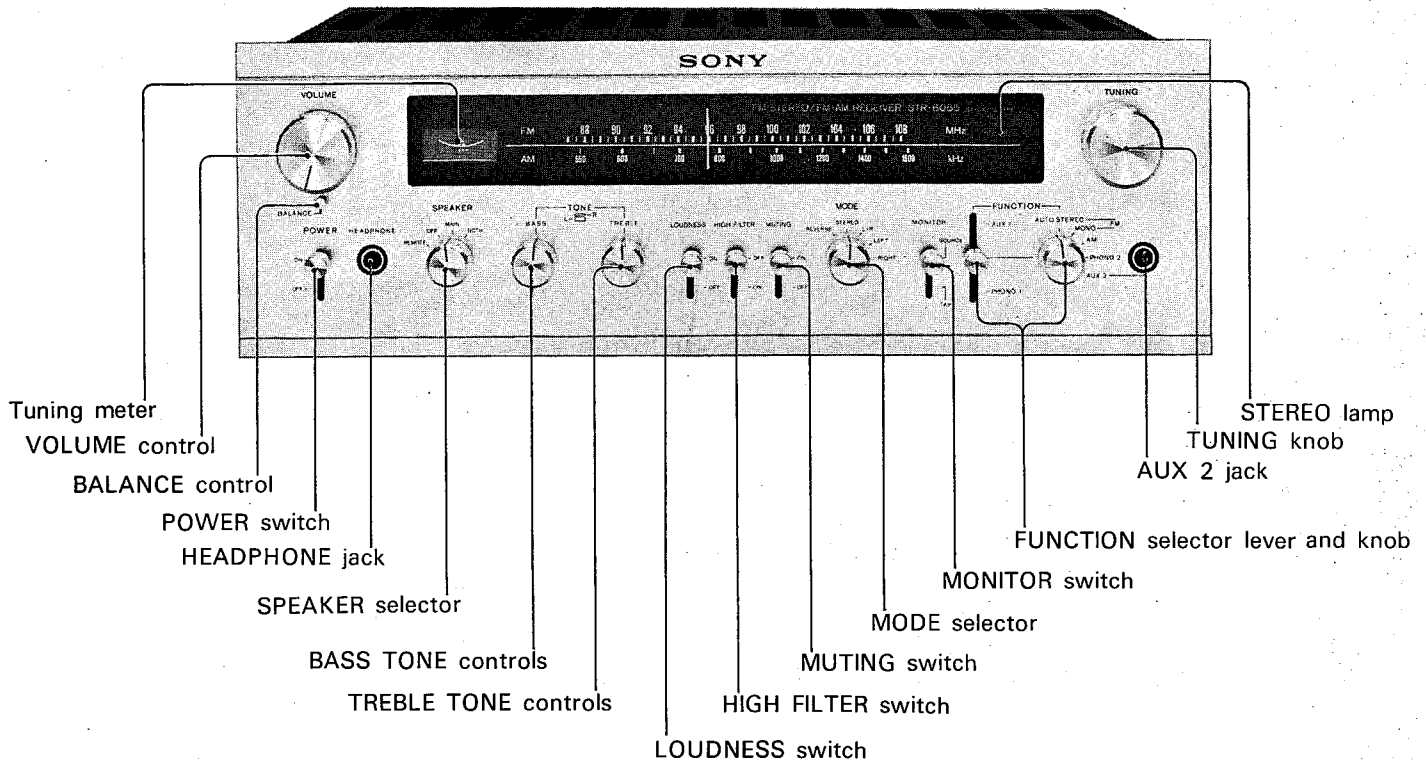

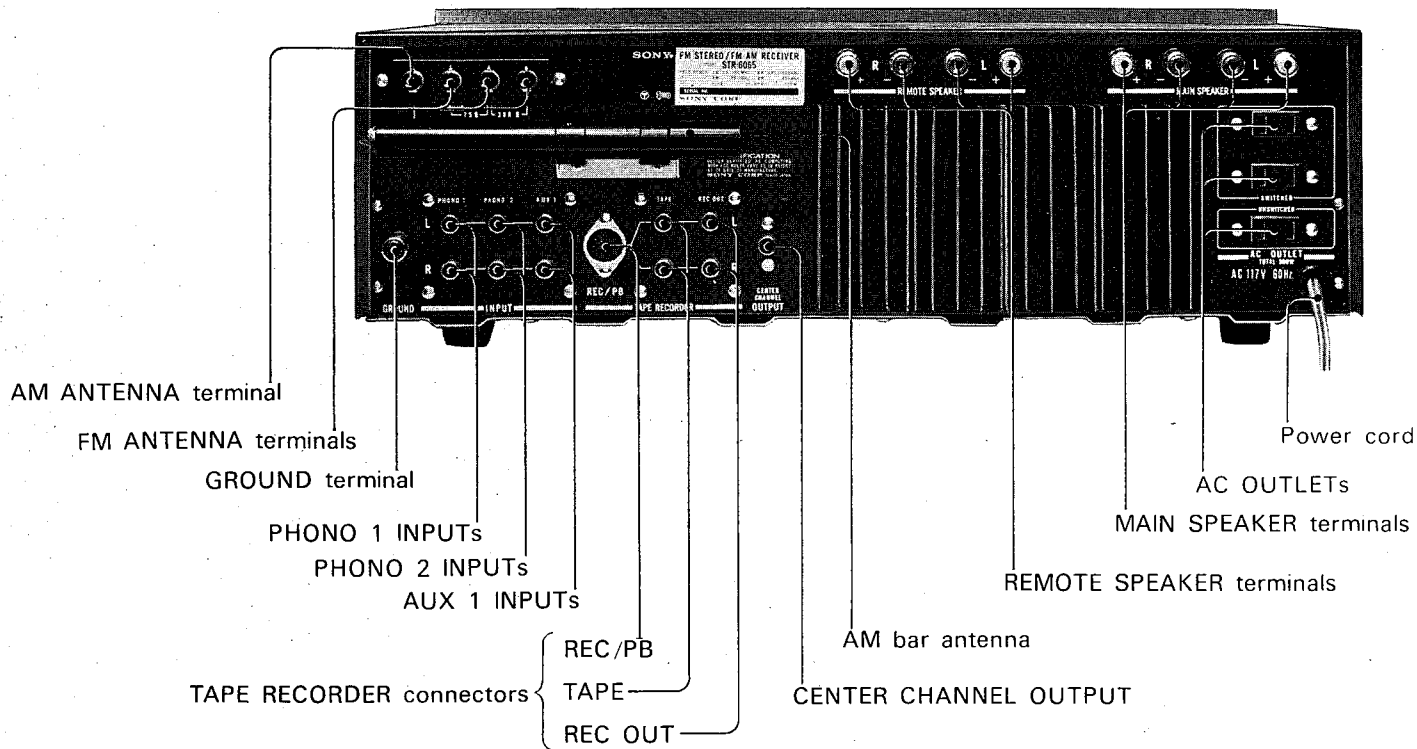

**POWER switch**

Set to ON to apply the power to the receiver. The dial will then light with a soft green glow.

**VOLUME control**

This knob regulates the overall sound volume level.

**BALANCE control**

This lever regulates the sound volume level of either left or right channels to produce the optimum stereo effect.

**SPEAKER selector**

- REMOTE ...For using the remote speakers only.
- OFF .....To switch the speakers off. For private listening, insert any low- or high-impedance stereo headphone into the HEADPHONE jack and set the selector to this position.
- MAIN .....For using the main speakers only.
- BOTH .....For using both main and remote speakers simultaneously.

**BASS and TREBLE TONE controls**

Control the prominence of BASS or TREBLE notes. Turn clockwise to increase bass (or treble) notes, counterclockwise to decrease response. The center position provides a flat response. The friction clutch knobs permit controlling the left and right channels simultaneously or independently. The outer knobs control the right channels, and the inner knobs control the left channels.

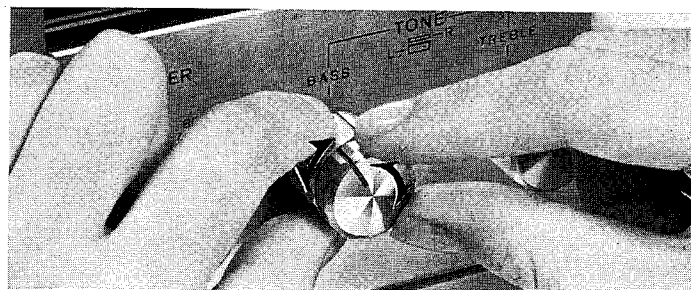

**LOUDNESS switch**

When this switch is set to ON, an equalization network is switched into the circuit to compensate for the change in the tonal response of human hearing at low sound levels. Your ear is most sensitive to those frequencies between 1,500 Hz and 6,000 Hz and at low level may not perceive frequencies above or below that range. The LOUDNESS switch will boost the low and high frequency response to provide an apparently flat output. It is automatically disconnected when the receiver is operated at high volume levels.

**HIGH FILTER switch**



Set this switch to ON to insert this filter. This switch reduces high-frequency noise such as the surface noise of discs or tapes when reproducing old or poor quality recordings, or high-frequency distortion in discs or tapes.

**MUTING switch**

This switch is usually set to ON. In this position, fm interstation noise is eliminated while tuning from station to station. However, very weak stations may also be muted along with the noise. Therefore, weak stations must be tuned with the MUTING switch set to OFF. In this case, keep the volume down when detuning to avoid the sudden change in noise level.

**MODE selector**

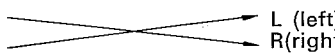
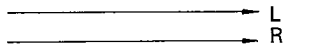
This knob determines the mode of the reproduced program at the SPEAKER terminals, REC OUT and HEADPHONE jack. The CENTER CHANNEL OUTPUT supplies monaural (L+R) signal when the selector is set to REVERSE, STEREO, or L+R. LEFT and RIGHT position supply either input signal.

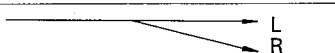
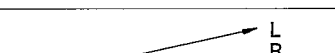
MODE selector setting	Input	Output	Use
REVERSE	L (left) R(right)	 L (left) R(right)	Reverse right and left stereo sound.
STEREO	L R	 L R	Normal stereo sound
L+R	L R	 L R	For balancing right and left channel sound level. For recording with a monaural tape recorder.
LEFT	L R	 L R	To amplify a monaural input source.
RIGHT	L R	 L R	

**MONITOR switch**

Taped programs connected to the TAPE inputs or to the REC/PB connector can be played back by setting this switch to TAPE. For all other program sources, set the switch to SOURCE and set the FUNCTION selector lever and knob to the proper positions.

This switch can also be used as a source/tape comparator when using a 3-head tape recorder (recorder having a third head and a playback preamplifier). The recording signal is monitored when the switch is set at SOURCE and the recorded signal is monitored when the switch is set at TAPE. In this case, the recorder should be connected to the TAPE and REC OUT connectors of the STR-6065.

**FUNCTION selector lever**

- AUX 1 .....Selects the input source connected to the AUX 1 jacks on the rear panel.
- Center position .....Enables you to listen to the program determined by the FUNCTION selector knob.
- PHONO 1 .....Selects the phonograph connected to the PHONO 1 jacks.

**FUNCTION selector knob**

- FM AUTO STEREO ...To listen to fm stereo programs.  
In this position the set will automatically switch to stereophonic reception when a multiplex fm stereo program is tuned in. When the program is changed to a monophonic signal, the STR-6065 will automatically switch to monophonic reception.
- FM MONO .....Provides monophonic reception of fm stereo and monophonic programs. Use this position if an fm stereo program is weak or noisy.
- AM .....Enables you to listen to a-m broadcast programs.
- PHONO 2 .....Selects the phonograph connected to the PHONO 2 jacks.
- AUX 2 .....Selects the program source connected to the AUX 2 binaural jack on the front panel.

**TUNING knob**

Turn this knob to tune in the desired station. Use the Tuning Meter to facilitate tuning.

**Tuning meter**

- For fm : While receiving fm programs, this meter acts as a zero-center indicator for the selected station. The relative strength on the selected signal is shown by the amount of meter deflection. The stronger the signal, the wider the pointer will swing.
- For a-m: While receiving a-m programs, the meter swings toward the right. The rightmost reading indicates the best tuning. The relative strength of the received signal is shown by the amount of meter deflection.

**STEREO lamp**

The red stereo lamp will light when an fm stereo program is tuned in. Also, the lamp will usually light on excessive noise.

## HOW TO USE YOUR STR-6065 FOR FM OR AM RECEPTION

Flip the POWER switch to ON. Set the SPEAKER selector to the proper position. Set the MODE selector to STEREO, set the MONITOR switch to SOURCE, and set the FUNCTION lever to the center position.

To receive an fm program, set the FUNCTION knob to AUTO STEREO and set the MUTING switch to ON. Tune in the desired station by turning the TUNING knob. The pointer of the Tuning Meter will be centered when a station is correctly tuned in. When the program is stereophonic, the STEREO lamp will light.

To receive an a-m program, set the FUNCTION knob to AM, and tune in the desired station. The pointer of the meter will swing rightmost when a station is correctly tuned in.

Adjust the sound level and tone quality by turning the VOLUME, BASS and TREBLE TONE controls. If necessary, set the HIGH FILTER switch to ON to eliminate high frequency noise (hiss). When listening at low sound levels, if desired, set the LOUDNESS switch to ON.

Note: The MUTING switch has no effect on a-m reception.

## HOW TO USE YOUR STR-6065 WITH A RECORD PLAYER

Connect a record player to the PHONO inputs of the STR-6065. Turn on the STR-6065. Set the SPEAKER selector to the proper position, set the MODE selector to STEREO, set the MONITOR switch to SOURCE, and set the FUNCTION lever to PHONO. Turn on the record player, then lower the pick-up cartridge onto the record. Adjust the sound volume and tone quality to your listening preference.

## HOW TO USE YOUR STR-6065 WITH A TAPE RECORDER

There are several ways to connect a tape recorder or a tape deck to the STR-6065. Ordinarily, the tape recorder is connected to the REC OUT and TAPE input connectors, or to the REC/PB connector.









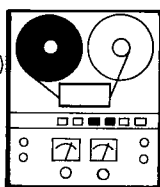

For tape playback, turn on the STR-6065 and the recorder. Set the SPEAKER selector to the proper position and set the MODE selector to STEREO. Set the MONITOR switch to TAPE. put the recorder in the playback mode. Adjust the sound volume and tone quality to your listening preference.

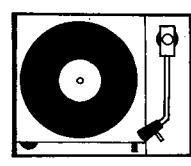
If the recorder output is connected to the AUX 1 (or 2) input jacks, set the MONITOR switch to SOURCE, and set the FUNCTION selector lever and/or knob to AUX 1 (or 2).

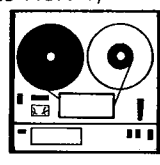
For recording, set the FUNCTION selector lever and/or knob to the desired program source, and put the recorder into the record mode. The MONITOR switch should be set at SOURCE.

When using a 3-head tape recorder, the recording signal can be monitored in the SOURCE position and the recorded signal can be monitored in the TAPE position. Then, instantaneous tape/source monitoring is possible by setting the MONITOR switch alternately to TAPE and SOURCE.

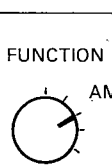
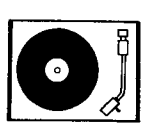
If the connected tape recorder is the monaural type, and the program source is stereophonic, set the MODE selector to L+R.

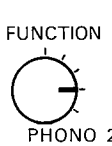
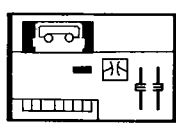
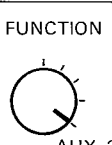
POSITION OF PROGRAM SOURCES CONTROLS	MONITOR SWITCH	FUNCTION SELECTOR LEVER	FUNCTION SELECTOR KNOB
Tape recorder (connected to TAPE or REC/PB) 			
Records (connected to PHONO 1) 			
Auxiliary sound source (connected to AUX 1) 			
Fm program			
A-m program			
Records (connected to PHONO 2) 			
Auxiliary sound source (connected to AUX 2) 			

## BALANCING THE STEREO SYSTEM

As soon as you are familiar with the operation of your STR-6065, make the following checks and adjustment in your stereo system to secure the best possible stereo listening.

### Stereo Balance

The feeling of direction and depth that stereophonic sound produces is greatly degraded if the levels of both channels are not balanced. Set the MODE selector to L+R, and adjust the BALANCE control lever for equal output from right and left speakers. Balance variations with different program sources are due to differences in the recording levels.

Stereo balance is also influenced by the acoustics of the room. Carpets, furniture placement, and room size and shape have a definite effect upon sound quality and balance.

### Speaker Phasing Check

Make sure your speakers are properly phased by performing this simple test. Move the right- and left-channel speakers so that they are about one foot apart and facing each other. Adjust the system controls for balanced L+R operation (by setting the MODE selector to L+R and the BALANCE control to center). Listen to a recorded passage containing prominent bass notes. Then, reverse the connection to one of the speakers and listen to the same bass passage again. If it now sounds like there is less bass, the speakers were correctly phased and the original connection should be restored. However, if the bass appears to have increased, the speakers were originally phased incorrectly and the new connection should be used.

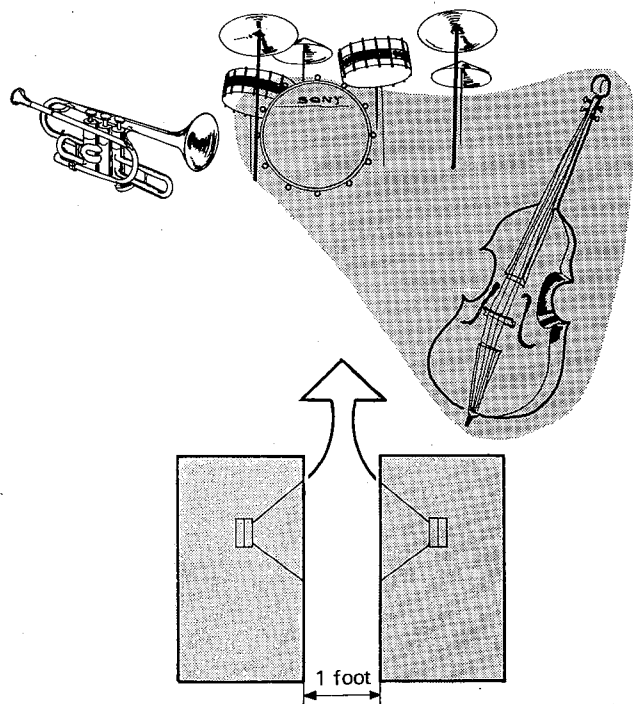

## CARE OF YOUR EQUIPMENT

### CLEANING

Finger prints, the kid's chocolate candy, and similar household annoyances can mar the beauty of your STR-6065. These can be cleaned up by wiping the panel, knobs or dial glass with a soft clean cloth moistened with water. Do not use any type of scouring powder, abrasive pad, or solvent.

### TROUBLE CHECKS

If trouble with the STR-6065 arises, make the following simple checks to determine if the trouble is really in the STR-6065 or external to it. Quite often hi-fi equipment fails to work properly because of incorrectly made system connections. If the trouble persists after you have made these checks, consult your SONY dealer for further instructions.

---

#### No audio and the dial lamp does not light.

Check the power cord connection.

---

#### No audio but the dial lamp lights.

Check the speaker connections.

Set the SPEAKER selector to REMOTE, MAIN, or BOTH. Set the MONITOR switch to SOURCE (except for tape playback).

Set the FUNCTION selector lever and knob properly.

Turn the VOLUME control clockwise.

---

#### No audio from one channel, or unbalanced output

Check the connections to each speaker.

Adjust the BALANCE control lever.

---

#### Severe hum or noise

Use shielded connection cables.

Avoid long horizontal runs.

Keep connection cables away from transformers or generators, and at least 10 feet from TV sets and fluorescent lights.

Reverse the ac plug in the receptacle.

Ground the amplifier.

---

#### Poor reception

Tune accurately and adjust the antenna (See page 4).

---

#### Stereo broadcast is noisy and distorted.

Adjust the antenna for maximum signal strength (See page 4).

Set the HIGH FILTER switch to ON and the FUNCTION selector knob to FM MONO.

---

#### STEREO lamp blinks on and off.

Adjust the antenna to eliminate weak or multipath reception.

---

#### STEREO lamp does not light when receiving stereo programs.

Set the FUNCTION selector knob to FM AUTO STEREO.

---

## TECHNICAL DATA

### TECHNICAL SPECIFICATIONS

#### Fm Tuner Section

Tuning range: 87.5 MHz-108 MHz  
 Antenna terminals: 300 ohm balanced  
 75 ohm unbalanced  
 Intermediate frequency: 10.7 MHz  
 Sensitivity: 2.2 $\mu$ V, IHF  
 1.8 $\mu$ V, S/N=30 dB  
 1.4 $\mu$ V, S/N=20 dB  
 Image rejection: 70 dB  
 I-f rejection: 90dB  
 Spurious rejection: 100 dB  
 A-m suppression: 65 dB  
 Capture ratio: 1.5 dB  
 Selectivity: 80 dB  
 S/N ratio: 70 dB

Frequency response: 20 Hz - 15 kHz  $\pm 0.5$  dB  
 $-1$   
 Harmonic distortion: Mono 0.2% at 400 Hz, 100% modulation  
 Stereo 0.5% at 400 Hz, 100% modulation  
 Stereo separation: 38 dB at 400 Hz  
 19 kHz, 38 kHz  
 suppression: 60 dB  
 SCA suppression: 55 dB  
 Muting level: Less than 5 $\mu$ V

#### A-m Tuner Section

Tuning range: 530 kHz - 1,605 kHz  
 Antenna: Built-in bar antenna and external antenna terminal  
 Intermediate frequency: 455 kHz  
 Sensitivity: 48 dB/m, built-in antenna  
 20 $\mu$ V, external antenna  
 Image rejection: 60 dB at 1,000 kHz  
 I-f rejection: 46 dB at 1,000 kHz  
 S/N ratio: 50 dB  
 Harmonic distortion: 0.8%

#### Amplifier Section

Dynamic power output: 220 watts/8 ohms  
 (IHF constant power supply method) 255 watts/4 ohms  
 Continuous RMS power output: At 1 kHz  
 (less than 0.2% THD) 70+70 watts/8 ohms  
 80+80 watts/4 ohms  
 Both channels driven simultaneously  
 At 20 Hz - 20 kHz  
 50+50 watts/8 ohms  
 Both channels driven simultaneously  
 Power bandwidth: 15 Hz - 30 kHz  
 (IHF)  
 Harmonic distortion: Less than 0.2% at rated output  
 Less than 0.1% at 1 watt output  
 IM distortion: Less than 0.2% at all power level

Frequency response: PHONO 1-2  
 RIAA equalization curve  $\pm 0.5$  dB  
 AUX 1-2 }  
 TAPE } 12 Hz - 70 kHz  $\pm 0$  dB  
 REC/PB (input) }  $-3$  dB

Inputs:	Sensitivity	Impedance
PHONO 1-2	1.4 mV	47k ohms
AUX 1-2	140 mV	100k ohms
TAPE	140 mV	100k ohms
REC/PB (input)	140 mV	100k ohms

Measured with rated output.

Outputs:	Output voltage	Impedance
REC OUT	250 mV	15k ohms
REC/PB (output)	30 mV	82k ohms
CENTER CHANNEL OUT	5V	1k ohm
HEADPHONE	Accepts low or high impedance	headphone.
SPEAKER	The most suitable speakers are	4-16 ohm speakers.

S/N ratio:	Weighting network	Input level
PHONO 1-2	B	1.4 mV
AUX 1-2 } TAPE } REC/PB (input) }	A	140 mV

Damping factor: 60/8 ohms  
 Tone controls: BASS (dual concentric knobs)  
 100 Hz  $\pm 10$  dB  
 TREBLE (dual concentric knobs)  
 10 kHz  $\pm 10$  dB

High filter: 6 dB/oct. above 5 kHz  
 Loudness switch: 50 Hz+10 dB, 10 kHz+4 dB  
 (Att. -30 dB)

#### General

System: Superheterodyne fm/a-m, switching MPX  
 Quasi-complementary symmetry circuit (SEPP OTL), Direct output coupling  
 Semiconductors: 3 FET+35 transistors for reception  
 2 FET+24 transistors for auxiliary circuits  
 65 diodes  
 Power requirements: Ac 117 volts, 50 Hz/60 Hz  
 Power consumption: 120 watts  
 Ac outlets: 2 switched, 1 unswitched  
 Total 300 watts  
 Dimensions: 17 $\frac{5}{16}$ (w)  $\times$  5 $\frac{13}{16}$ (h)  $\times$  13 $\frac{5}{16}$ (d) inches  
 Weight: 29 lbs 12 ozs (net)  
 38 lbs 9 ozs (in shipping carton)  
 Supplied accessories: Feeder antenna (1)  
 Pin plugs (4)  
 Binaural plug (1)  
 Polishing cloth (1)

Design and specifications subject to change without notice.

# BLOCK DIAGRAM

## TUNER BLOCK

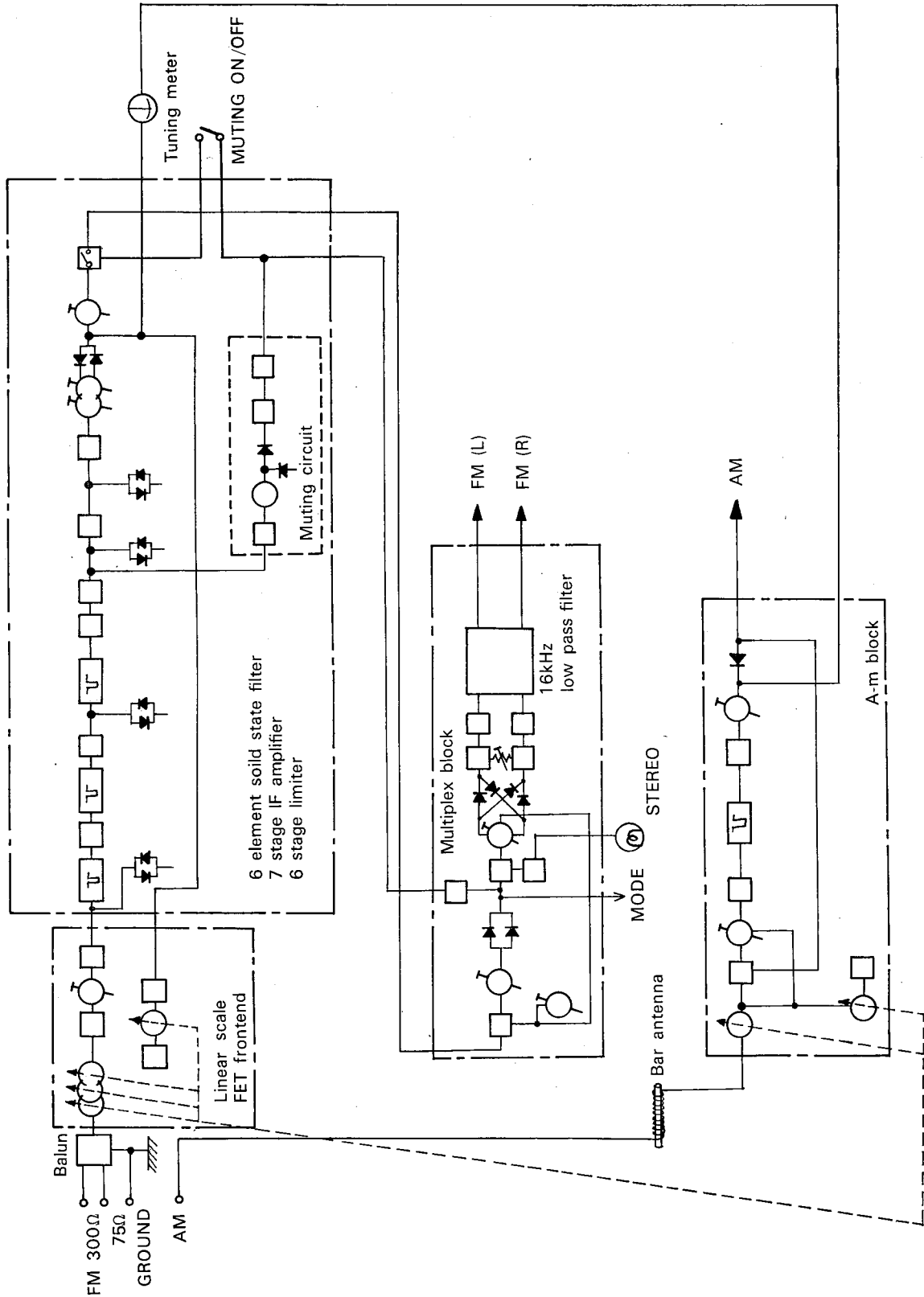



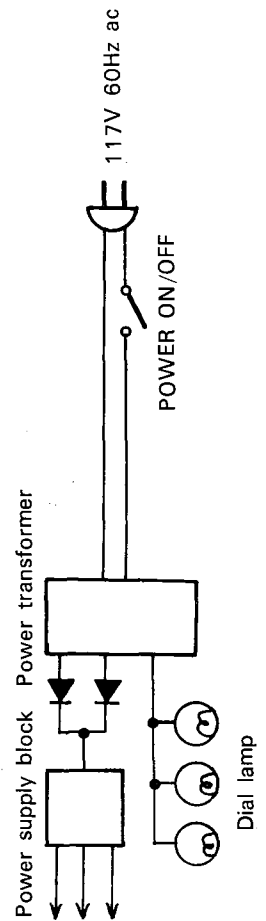
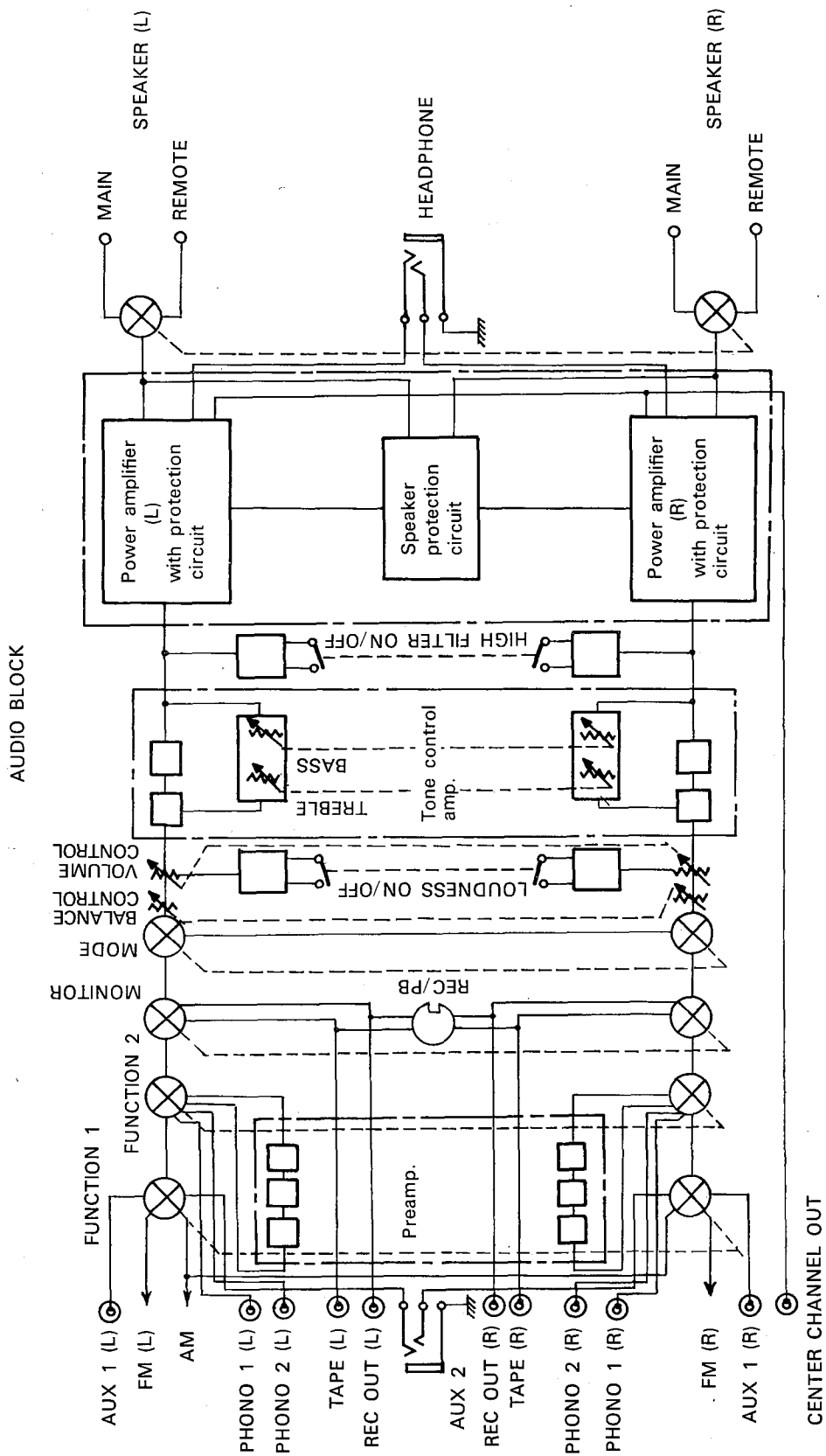

## REPACKING FOR SHIPMENT

The STR-6065's original shipping carton and packing material (which we asked you to save) is the ideal container for shipping the unit for repair work, or simply to another location. However, to achieve the maximum protection, the STR-6065 must be repacked in this material precisely as before. The proper repacking procedure is as shown in the illustration.

