

# TA-N55ES/N330ES

## SERVICE MANUAL



TA-N330ES

*E Model*  
TA-N330ES  
*US Model*  
*Canadian Model*  
*AEP Model*  
*UK Model*  
TA-N55ES

### SPECIFICATIONS

#### AUDIO POWER SPECIFICATIONS

##### POWER OUTPUT AND TOTAL HARMONIC DISTORTION:

With 4 ohm loads, both channels driven, from 20 - 20,000 Hz; rated 150 watts per channel minimum RMS power, with no more than 0.01 % total harmonic distortion from 250 milliwatts to rated output.

With 8 ohm loads, both channels driven, from 20 - 20,000 Hz; rated 110 watts per channel minimum RMS power, with no more than 0.05 % total harmonic distortion from 250 milliwatts to rated output.

#### Other specifications

Item	Condition	Model except for North Europe	Model for North Europe
Continuous RMS power output(both channels driven simultaneously)	4 ohms 20 Hz - 20 kHz, THD 0.01 %	150 W + 150 W (DIN: 160 W + 160 W)	—
	6 ohms 20 Hz - 20 kHz, THD 0.03 %	125 W +125 W (DIN: 135 W + 135 W)	100 W + 100 W (DIN: 120 W + 120 W)
	8 ohms 20 Hz - 20 kHz, THD 0.05 %	110 W+ 110 W (DIN: 120 W + 120 W)	80 W + 80 W (DIN: 110 W + 110 W)
	8 ohms monaural, THD 0.05 %	300 W (DIN: 350 W)	—
	12 ohms monaural, THD 0.05 %	—	200 W (DIN: 235 W)

— continued on next page —

STEREO POWER AMPLIFIER  
**SONY**<sup>®</sup>

Dynamic power	1 ohm stereo (monaural)	450 W (—)	450 W (—)
	2 ohms stereo (monaural)	400 W (750 W)	325 W (625 W)
	4 ohms stereo (monaural)	290 W (680 W)	220 W (450 W)
	8 ohms stereo (monaural)	150 W (500 W)	125 W (370 W)
Power bandwidth (IHF)	4 ohms, THD 0.05 %	5 Hz - 50 kHz at 75W	—
	8 ohms, THD 0.05 %	5 Hz - 50 kHz at 55 W	
Dynamic headroom ('78 IHF)	4 ohms	2.8 dB	—
	8 ohms	1.8 dB	
Total harmonic distortion	4 ohms, at 10 watt output	0.008 %	—
	6 ohms, at 10 watt output	0.006 %	
	8 ohms, at 10 watt output	0.004 %	
Intermodulation (IM) distortion 60 Hz:7 kHz = 4:1	4 ohms, at rated output	0.008%	—
	6 ohms, at rated output	0.006%	
	8 ohms, at rated output	0.004%	
Damping factor	8 ohms, 1 kHz	100	
Slew rate	—	120 V/μsec, 250 V/μsec (inside)	
Residual noise	network A	Less than 90 μV	
Frequency response	INPUT	5 Hz - 200 kHz +0 -3 dB	5 Hz - 100 kHz +0 -3 dB
Input sensitivity	INPUT	180 mV, 20 kohms	
S/N (network) '78 IHF	INPUT	120 dB (A)	

## General

**System** Super legato linear, purecomplementary SEPP power amplifier, powerful power supply

### Power requirements

Model for U.S.A. and Canada:

120 V AC, 60 Hz

Model for continental Europe:

220 V AC, 50/60 Hz

Model for United Kingdom:

240 V AC, 50 Hz

Model for other countries:

120, 220 or 240 V AC, adjustable, 50/60 Hz

### Power consumption

Model for U.S.A.: 280 watts

Model for Canada: 580 VA

Model for United Kingdom: 760 watts

Model for North Europe: 190 watts

Model for Europe and other countries: 310 watts

### Dimensions

Model for United Kingdom:

Approx. 430 x 150 x 365 mm (w/h/d)

(16 7/8 x 5 7/8 x 14 3/8 inches)

Other models:

Approx. 467 x 150 x 365 mm (w/h/d)

(18 3/8 x 5 7/8 x 14 3/8 inches)

### Weight

Model for United Kingdom:

Approx. 11.2 kg (24 lb. 12 oz.), net

Other models:

Approx. 12.2 kg (26 lb. 14 oz.), net

### Supplied accessories

Screws (8) (except for U.K. model)

Design and specifications subject to change without notice.

## MODEL IDENTIFICATION

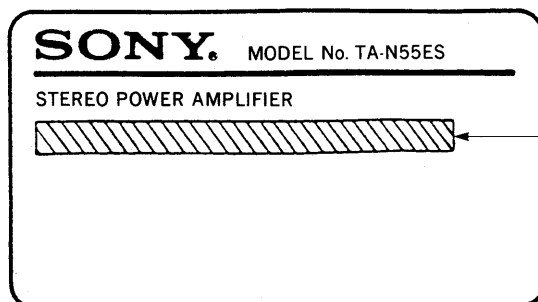

— Specification Label —



US model: AC 120V 60Hz 280W  
 Canadian model: AC 120V 60Hz 580VA  
 AEP, WG (West Germany) model: AC 220V~50/60Hz  
 UK model: AC 240V~50/60Hz

## SERVICING NOTES

### SAFETY-RELATED COMPONENT WARNING!!

COMPONENTS IDENTIFIED BY MARK  OR DOTTED LINE WITH MARK  ON THE SCHEMATIC DIAGRAMS AND IN THE PARTS LIST ARE CRITICAL TO SAFE OPERATION. REPLACE THESE COMPONENTS WITH SONY PARTS WHOSE PART NUMBERS APPEAR AS SHOWN IN THIS MANUAL OR IN SUPPLEMENTS PUBLISHED BY SONY.

### ATTENTION AU COMPOSANT AYANT RAPPORT À LA SÉCURITÉ!

LES COMPOSANTS IDENTIFIÉS PAR UNE MARQUE  SUR LES DIAGRAMMES SCHÉMATIQUES ET LA LISTE DES PIÈCES SONT CRITIQUES POUR LA SÉCURITÉ DE FONCTIONNEMENT. NE REMPLACER CES COMPOSANTS QUE PAR DES PIÈCES SONY DONT LES NUMÉROS SONT DONNÉS DANS CE MANUEL OU DANS LES SUPPLÉMENTS PUBLIÉS PAR SONY.

### SAFETY CHECK-OUT

After correcting the original service problem, perform the following safety check before releasing the set to the customer:

Check the antenna terminals, metal trim, "metallized" knobs, screws, and all other exposed metal parts for AC leakage. Check leakage as described below.

### LEAKAGE TEST

The AC leakage from any exposed metal part to earth ground and from all exposed metal parts to any exposed metal part having a return to chassis, must not exceed 0.5mA (500 microamperes). Leakage current can be measured by any one of three methods.

1. A commercial leakage tester, such as the Simpson 229 or RCA WT-540A. Follow the manufacturers' instructions to use these instruments.
2. A battery-operated AC milliammeter. The Data Precision 245 digital multimeter is suitable for this job.
3. Measuring the voltage drop across a resistor by means of a VOM or battery-operated AC voltmeter. The "limit" indication is 0.75V, so analog meters must have an accurate low-voltage scale. The Simpson 250 and Sanwa SH-63Trd are examples of a passive VOM that is suitable. Nearly all battery operated digital multimeters that have a 2V AC range are suitable. (See Fig. A)

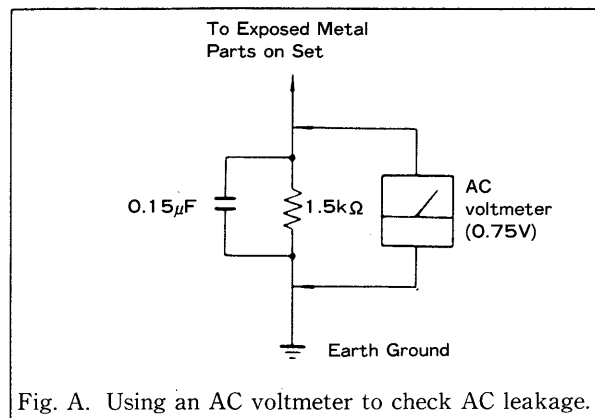
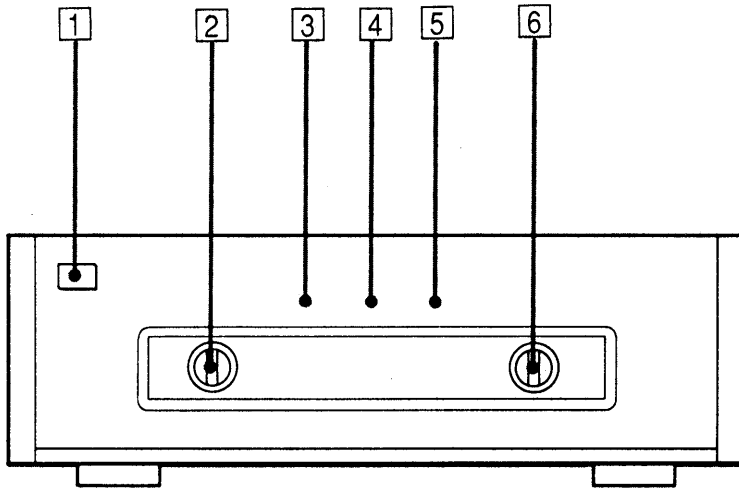

Fig. A. Using an AC voltmeter to check AC leakage.

## SECTION 1 GENERAL



**1 POWER switch**

**2 SPEAKERS selector**

Selects speaker system A, B or both (A+B).  
For headphone monitoring on the connected preamplifier, set the selector to OFF.

**3 PROTECTION indicator**

Lights up for approximately 4 seconds immediately after turning on the unit. This indicates that the built-in muting circuit is activated.

In normal operating conditions, this does not light. If it lights up (speaker sound is not heard) while operating, an abnormality has occurred. In this case, disconnect the AC power cord and check the connected components and speaker systems.

**4 STEREO indicator**

Lights up when OPERATION is set to STEREO.

**5 MONO indicator**

Lights up when OPERATION is set to MONO.

**6 ATTENUATOR**

Control input signal sound level from the preamplifier.  
Normally, set it to the click-in center position.

## SECTION 2 ELECTRICAL ADJUSTMENTS

### PRECAUTIONS

1. Adjust the idling after tuning the unit on for about 10-15 minutes, giving it time to warm up.
2. Always make sure to adjust the idling when repairing the power amp section or when replacing any parts.

### [IDLING ADJUSTMENT]

Procedure :

Set the ATTENUATOR control as low as possible and adjust RT301 (L-CH) and RT351 (R-CH) so that the voltmeter reads 7mV at TP301 (L-CH) and TP351 (R-CH).

**Adjustment Location :** power board

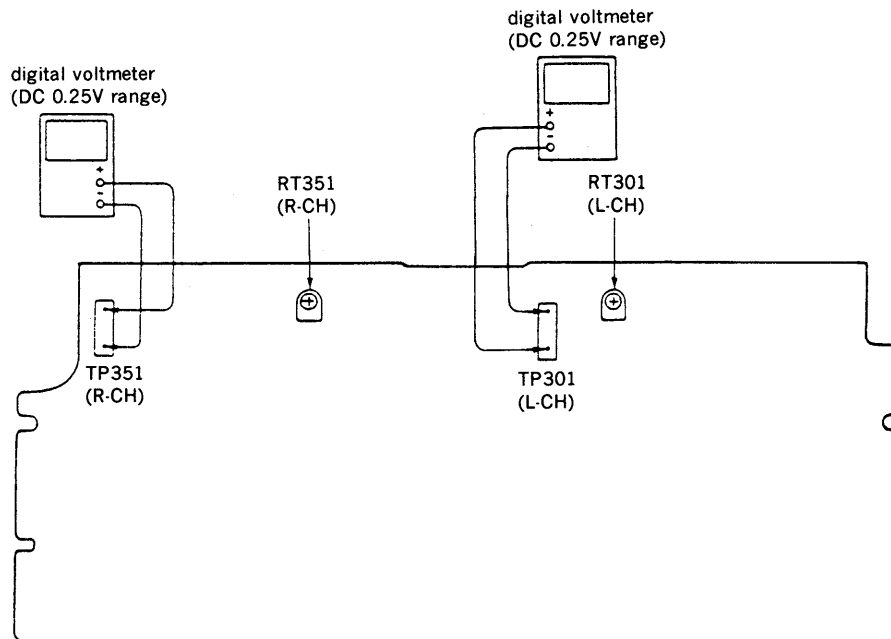

SECTION 3  
DIAGRAMS

3-2. PRINTED WIRING BOARDS

3-1. CIRCUIT BOARDS LOCATION

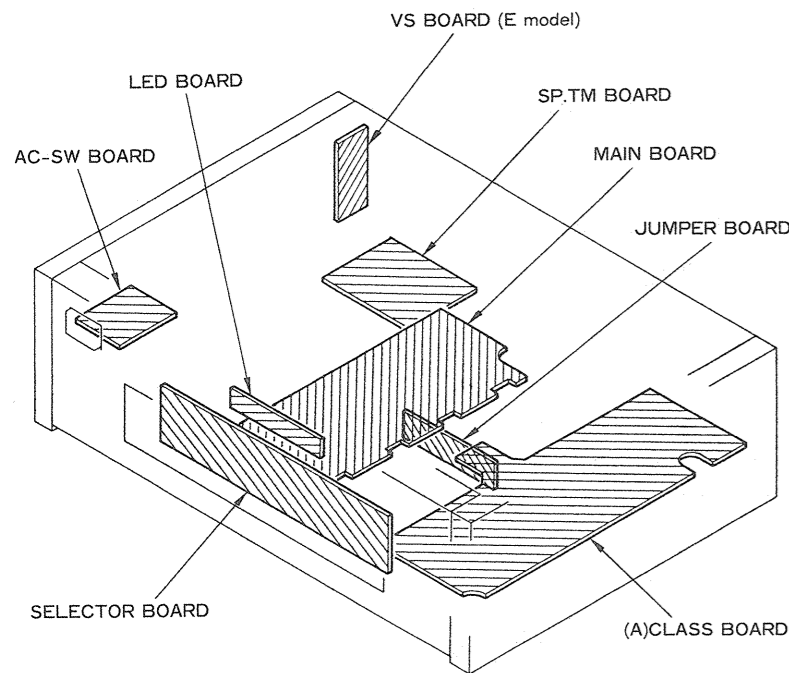

● Semiconductor Locations

Ref. No.	Location
D201	I-10
D202	I-10
D203	J-10
D204	J-8
D205	J-7
D206	C-11
D207	C-10
D301	E-18
D302	F-19
D303	G-19
D304	G-18
D305	C-18
D306	C-18
D307	G-18
D308	G-19
D309	G-18
D310	G-18
D311	H-18
D312	J-16
D313	J-16
D314	I-15
D362	C-16
D363	C-16
D364	D-15
IC101	D-2
IC102	F-2
IC103	F-3
IC301	H-3
IC302	I-18
Q201	I-10
Q202	H-10
Q203	H-9
Q204	H-8
Q301	I-15
Q302	I-16
Q303	I-16
Q304	J-15
Q305	H-15
Q306	J-16
Q351	D-15
Q352	D-16
Q353	E-16
Q354	C-15
Q355	E-15
Q356	C-16

Note:  
 ○ : parts extracted from the component side.  
 ● : parts mounted on the conductor side.

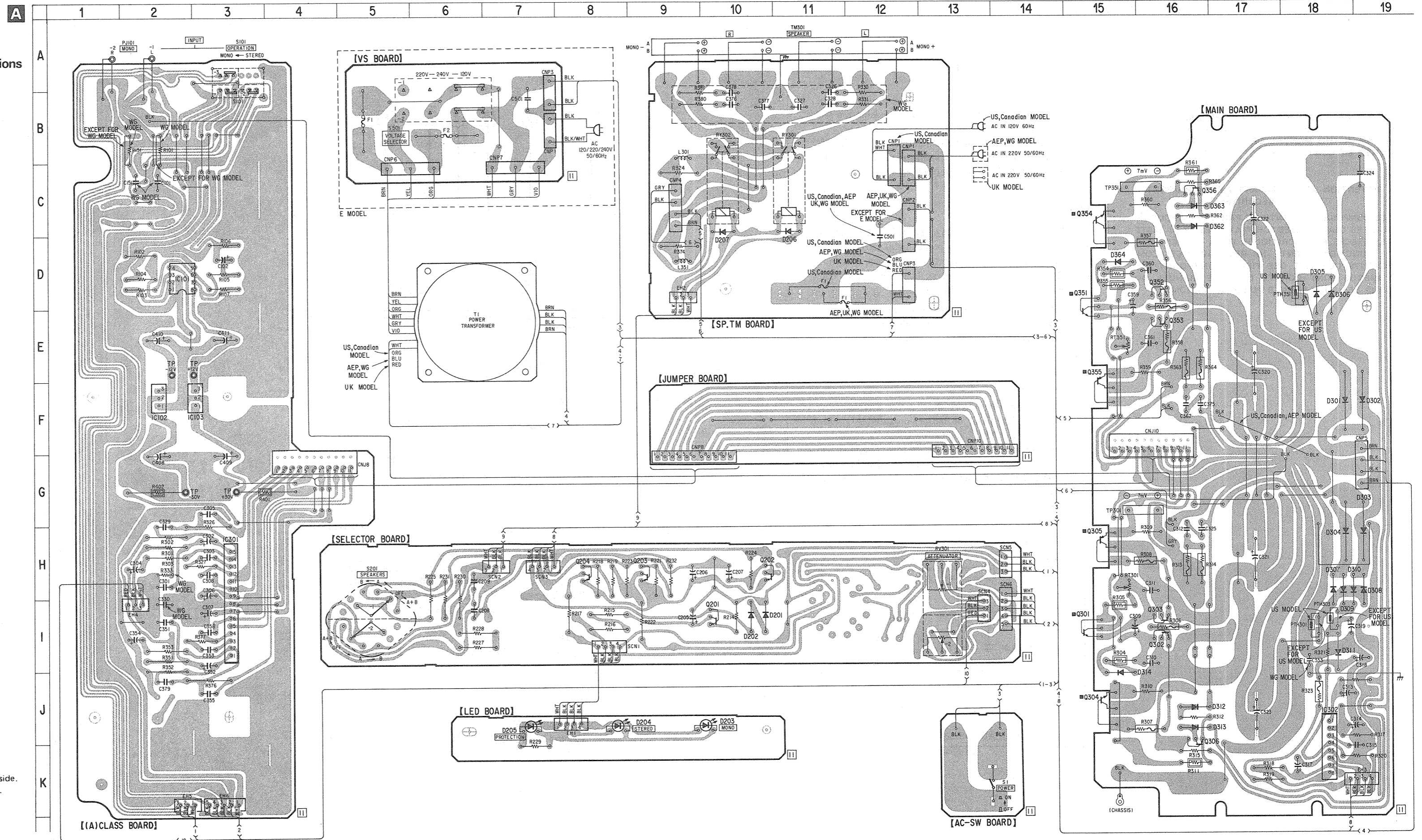









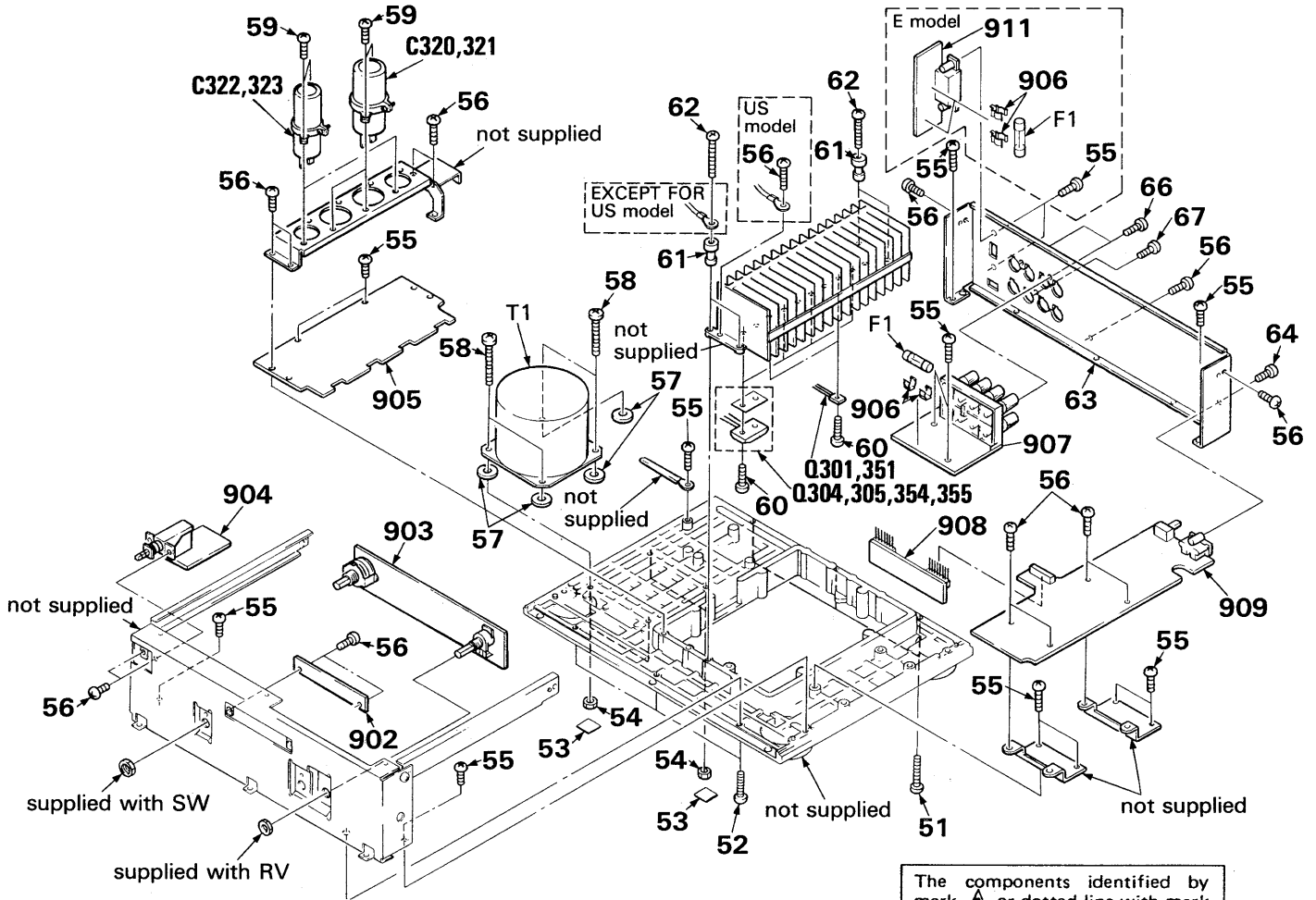







## 4-2. SHASSIS SECTION



No.	Part No.	Description	Ramerks	No.	Part No.	Description	Ramerks
51	7-685-876-09	SCREW +BVTT 3X16 (S)		902	*1-631-657-11	PC BOARD, LED	
52	7-685-873-09	SCREW +BVTT 3X10 (S)		903	*1-631-654-11	PC BOARD, SELECTOR	
53	*4-929-266-01	CUSHION		904	*1-631-870-11	PC BOARD, AC-SW	
54	7-684-024-04	N 4, TYPE 2					
55	7-685-647-79	SCREW +BVTP 3X10 TYPE2 SLIT		905	*A-4333-769-A	(US).....MOUNTED PCB, MAIN (B)	
					*A-4333-770-A	(Canadian)...MOUNTED PCB, MAIN (B)	
56	7-682-547-09	SCREW +BVTT 3X6 (S)			*A-4333-771-A	(WG).....MOUNTED PCB, MAIN (B)	
57	4-885-984-21	WASHER			*A-4333-772-A	(UK).....MOUNTED PCB, MAIN (B)	
58	7-682-566-09	SCREW +B 4X20			*A-4333-773-A	(E).....MOUNTED PCB, MAIN (B)	
59	7-685-872-09	SCREW +BVTT 3X8 (S)			*A-4333-783-A	(AEP).....MOUNTED PCB, MAIN (B)	
60	7-685-648-79	SCREW +BVTP 3X12 TYPE2 IT-3		906	1-533-183-11	(E,AEP,WG,UK)...HOLDER, FUSE	
61	4-933-025-11	(US)...COLLAR			1-533-185-11	(US,Canadian)...HOLDER, FUSE	
62	7-685-152-19	(US)...SCREW +P 3X25 TYPE2 SLIT		907	*1-631-658-11	PC BOARD, SP.TM	
	7-685-650-79	(EXCEPT FOR US)...SCREW +BVTP 3X16 TYPE2 SLIT		908	*1-631-656-11	PC BOARD, JUMPER	
63	*4-933-015-01	(US,Canadian,AE1,WG,UK)...PANEL, BACK		909	*1-631-655-11	PC BOARD, (A) CLASS	
	*4-933-015-11	(AE2).....PANEL, BACK		911	*1-631-652-11	(E)...PC BOARD, VS	
	*4-933-015-21	(E).....PANEL, BACK					
64	7-621-849-00	SCREW, TAPPING		C320	1-125-460-11	CAP, ELECT 12000MF	
66	7-685-647-79	SCREW +BVTP 3X10 TYPE2 SLIT		C321	1-125-460-11	CAP, ELECT 12000MF	
67	7-621-849-00	(WG)..... SCREW, TAPPING		C322	1-125-558-11	CAP, ELECT 5600MF	
	7-685-647-79	(EXCEPT FOR WG)...SCREW +BVTP 3X10 TYPE2 SLIT		C323	1-125-558-11	CAP, ELECT 5600MF	
901	 .1-557-577-11	(US,Canadian)...CORD, POWER		F1	 .1-532-350-00	(E,AEP,WG,UK)...FUSE, TIME-LAG T4	
	 .1-574-804-11	(UK).....CORD, POWER		F1	 .1-532-510-00	(US,Canadian)...FUSE, GLASS TUBE 8A	
	 .1-574-805-11	(AEP,WG).....CORD, POWER		T1	 .1-449-787-11	(AE1,WG).....TRANSFORMER, POWER	
				T1	 .1-449-788-11	(E).....TRANSFORMER, POWER	
				T1	 .1-449-789-11	(UK).....TRANSFORMER, POWER	
				T1	 .1-449-790-11	(US,Canadian)...TRANSFORMER, POWER	
				T1	 .1-449-792-11	(AE2).....TRANSFORMER, POWER	

# SECTION 5 ELECTRICAL PARTS LIST

**NOTE:**

- Due to standardization, replacements in the parts list may be different from the parts specified in the diagrams or the components used on the set.
- Items marked "\*" are not stocked since they are seldom required for routine service. Some delay should be anticipated when ordering these items.
- If there are two or more same circuits in a set such as a stereophonic machine, only typical circuit parts may be indicated and capacitors and resistors in other same circuits may be omitted.

**CAPACITORS:**

MF:  $\mu$ F, PF:  $\mu$  $\mu$ F.

**RESISTORS**

- All resistors are in ohms.
- F: nonflammable

**COILS**

- MMH: mH, UH:  $\mu$ H

**SEMICONDUCTORS**

In each case, U:  $\mu$ , for example:  
 UA....:  $\mu$ A...., UPA....:  $\mu$ PA....,  
 UPC....:  $\mu$ PC, UPD....:  $\mu$ PD....

The components identified by mark  $\Delta$  or dotted line with mark  $\Delta$  are critical for safety. Replace only with part number specified.

Les composants identifiés par une marque  $\Delta$  sont critiques pour la sécurité. Ne les remplacer que par une pièce portant le numéro spécifié.

WG: West Germany

Ref.No	Part No.	Description			
901	$\Delta$ 1-557-577-11	(US, Canadian)....CORD, POWER			
901	$\Delta$ 1-574-804-11	(UK)....CORD, POWER			
901	$\Delta$ 1-574-805-11	(AEP, WG)....CORD, POWER			
902	* 1-631-657-11	PC BOARD, LED			
903	* 1-631-654-11	PC BOARD, SELECTOR			
904	* 1-631-870-11	PC BOARD, AC-SW			
905	* A-4333-769-A	(US)....MOUNTED PCB, MAIN (B)			
905	* A-4333-770-A	(Canadian)....MOUNTED, PCB, MAIN (B)			
905	* A-4333-771-A	(WG)....MOUNTED PCB, MAIN (B)			
905	* A-4333-772-A	(UK)....MOUNTED PCB, MAIN (B)			
905	* A-4333-773-A	(E)....MOUNTED PCB, MAIN(B).			
905	* A-4333-783-A	(AEP)....MOUNTED PCB, MAIN (B)			
906	* 1-533-183-11	(AEP, UK, WG)....HOLDER, FUSE			
906	* 1-533-185-11	(US, Canadian)....HOLDER, FUSE			
907	* 1-631-658-11	PC BOARD, SP.TM			
908	* 1-631-656-11	PC BOARD, JUMPER			
909	* 1-631-655-11	PC BOARD, (A) CLASS			
910	$\Delta$ 1-526-565-00	(E)....AC PLUG ADAPTOR			
911	* 1-631-652-11	(E)....PC BOARD, VS			
<b>CAPACITOR</b>					
C101	1-104-276-11	(WG).... POLYSTYRENE	68PF	10%	50V
C102	1-124-915-11	ELECT	10MF	20%	63V
C151	1-104-276-11	(WG).... POLYSTYRENE	68PF	10%	50V
C205	1-123-369-00	ELECT	4.7MF	20%	63V
C206	1-123-380-00	ELECT	1MF	20%	63V
C207	1-124-918-11	ELECT	47MF	20%	63V
C208	1-130-475-00	MYLAR	0.0022MF	5%	50V
C209	1-130-475-00	MYLAR	0.0022MF	5%	50V
C301	1-104-276-11	POLYSTYRENE	68PF	10%	50V
C302	1-124-915-11	ELECT	10MF	20%	63V
C303	1-104-276-11	POLYSTYRENE	68PF	10%	50V
C304	1-124-130-00	ELECT	100MF	20%	63V
C305	1-107-276-11	MICA	3PF	0.5PF	500V
C306	1-123-369-00	ELECT	4.7MF	20%	63V
C307	1-123-369-00	ELECT	4.7MF	20%	63V
C308	1-107-206-00	MICA	15PF	5%	500V
C309	1-124-929-11	ELECT	22MF	20%	63V
C310	1-107-159-00	MICA	33PF	5%	500V
C311	1-107-159-00	MICA	33PF	5%	500V
C312	1-136-161-00	FILM	0.047MF	5%	50V
C313	1-123-369-00	ELECT	4.7MF	20%	63V
C314	1-123-333-00	ELECT	100MF	20%	25V
C315	1-130-487-00	MYLAR	0.022MF	5%	50V
C317	1-123-330-00	ELECT	22MF	20%	16V
C318	1-124-919-11	ELECT	220MF	20%	63V
C319	1-124-499-11	ELECT	1MF	20%	100V
C320	1-125-460-11	ELECT	12000MF	20%	63V
C321	1-125-460-11	ELECT	12000MF	20%	63V
C322	1-125-558-11	ELECT	5600MF	20%	63V
C323	1-125-558-11	ELECT	5600MF	20%	63V
C324	1-136-880-11	(WG)....FILM	2.2MF	10%	160V
C324	1-136-601-11	(EXCEPT FOR WG).... FILM	0.01MF	10%	630V

Ref.No	Part No.	Description			
C325	1-136-161-00	FILM	0.047MF	5%	50V
C326	1-130-471-00	(WG)....FILM	0.001MF	5%	50V
C327	1-109-621-00	(WG)....MICA	220PF	5%	500V
C328	1-130-471-00	(WG)....FILM	0.001MF	5%	50V
C329	1-104-278-91	POLYSTYRENE	100PF	5%	50V
C330	1-161-370-00	(WG).... CERAMIC	0.01MF	30%	25V
C333	1-130-471-00	(WG)....MYLAR	0.001MF	5%	50V
C351	1-104-276-11	POLYSTYRENE	68PF	10%	50V
C352	1-124-915-11	ELECT	10MF	20%	63V
C353	1-104-276-11	POLYSTYRENE	68PF	10%	50V
C354	1-124-130-00	ELECT	100MF	20%	63V
C355	1-107-276-11	MICA	3PF	0.5PF	500V
C358	1-107-206-00	MICA	15PF	5%	500V
C359	1-124-929-11	ELECT	22MF	20%	63V
C360	1-107-159-00	MICA	33PF	5%	500V
C361	1-107-159-00	MICA	33PF	5%	500V
C362	1-136-161-00	FILM	0.047MF	5%	50V
C375	1-136-161-00	FILM	0.047MF	5%	50V
C376	1-130-471-00	(WG)....FILM	0.001MF	5%	50V
C377	1-109-621-00	(WG)....MICA	220PF	5%	500V
C378	1-130-471-00	(WG)....FILM	0.001MF	5%	50V
C379	1-104-278-91	POLYSTYRENE	100PF	5%	50V
C408	1-124-918-11	(US)....ELECT	47MF	20%	63V
C408	1-123-377-00	(EXCEPT FOR US).... ELECT	470MF	20%	63V
C409	1-124-918-11	(US)....ELECT	47MF	20%	63V
C409	1-123-377-00	(EXCEPT FOR US).... ELECT	470MF	20%	63V
C410	1-124-918-11	(US)....ELECT	47MF	20%	63V
C410	1-123-377-00	(EXCEPT FOR US).... ELECT	470MF	20%	63V
C411	1-124-918-11	(US)....ELECT	47MF	20%	63V
C411	1-123-377-00	(EXCEPT FOR US).... ELECT	470MF	20%	63V
C501	$\Delta$ 1-161-741-00	CERAMIC	0.001MF	10%	400V
CNJ8	* 1-563-381-11	SOCKET, CONNECTOR 11P			
CNJ10	* 1-563-381-11	SOCKET, CONNECTOR 11P			
CNP1	* 1-564-321-00	(E, AEP, UK, WG)....PIN, CONNECTOR 2P			
CNP2	* 1-565-792-11	PIN, CONNECTOR 2P			
CNP3	* 1-564-321-00	PIN, CONNECTOR 2P			
CNP4	* 1-564-241-00	PIN, CONNECTOR 4P			
CNP5	* 1-564-241-00	PIN, CONNECTOR 4P			
CNP6	* 1-564-687-11	(E)....PIN CONNECTOR 3P			
CNP7					
CNP8	1-568-203-11	PIN, CONNECTOR (PC BOARD) 11P			
CNP10	1-568-203-11	PIN, CONNECTOR (PC BOARD) 11P			
D201	8-719-912-20	DIODE 1SS120			
D202	8-719-912-20	DIODE 1SS120			
D203	8-719-303-00	DIODE SEL2510C			
D204	8-719-303-00	DIODE SEL2510C			
D205	8-719-301-39	DIODE SEL2210S			
D206	8-719-912-20	DIODE 1SS120			
D207	8-719-912-20	DIODE 1SS120			

Ref.No	Part No.	Description
D301	8-719-230-02	DIODE 30DF2
D302	8-719-230-02	DIODE 30DF2
D303	8-719-230-02	DIODE 30DF2
D304	8-719-230-02	DIODE 30DF2
D305	8-719-200-77	DIODE 10E2N
D306	8-719-200-77	DIODE 10E2N
D307	8-719-200-77	DIODE 10E2N
D308	8-719-200-77	DIODE 10E2N
D309	8-719-200-77	DIODE 10E2N
D310	8-719-200-77	DIODE 10E2N
D311	8-719-200-77	DIODE 10E2N
D312	8-719-912-20	DIODE 1SS120
D313	8-719-912-20	DIODE 1SS120
D314	8-719-912-20	DIODE 1SS120
D362	8-719-912-20	DIODE 1SS120
D363	8-719-912-20	DIODE 1SS120
D364	8-719-912-20	DIODE 1SS120
EH1	*1-564-507-11	PLUG, CONNECTOR 4P
EH2	*1-564-506-11	PLUG, CONNECTOR 3P
EH3	*1-564-507-11	PLUG, CONNECTOR 4P
EH4	*1-564-506-11	PLUG, CONNECTOR 3P
EH5	*1-564-506-11	PLUG, CONNECTOR 3P
EH6	*1-564-508-11	PLUG, CONNECTOR 5P
F1	△ 1-532-350-00	(E, AEP, UK, WG)....FUSE, TIME-LAG T4A
F1	△ 1-532-510-00	(US, Canadian)....FUSE, GLASS TUBE 8A
F2	△ 1-532-350-00	(E)....FUSE, TIME-LAG T4A
IC101	8-759-602-83	IC M5238P
IC102	8-759-604-39	IC M5F78M12
IC103	8-759-604-45	IC M5F79M12
IC301	8-749-920-70	IC STK3102-3
IC302	8-759-111-68	IC UPC1237HA
L301	*1-420-872-00	COIL, AIR CORE
L351	*1-420-872-00	COIL, AIR CORE
PJ101	1-568-250-11	(US, Canadian, AEP, UK, WG)....JACK, PIN 2P(INPUT MONO)
PJ101	1-568-250-21	(E)....JACK, PIN 2P(INPUT MONO)
PTH301	1-202-850-00	(US)....THERMISTOR (POSITIVE)
PTH303	1-202-850-00	(US)....THERMISTOR (POSITIVE)
PTH351	1-202-850-00	(US)....THERMISTOR (POSITIVE)
Q201	8-729-140-96	TRANSISTOR 2SD774-34
Q202	8-729-194-57	TRANSISTOR 2SC945-P
Q203	8-729-119-76	TRANSISTOR 2SA1175-HFE
Q204	8-729-119-76	TRANSISTOR 2SA1175-HFE
Q301	8-729-203-45	TRANSISTOR 2SC3423-O
Q302	8-729-127-53	TRANSISTOR 2SC2275-P
Q303	8-729-190-53	TRANSISTOR 2SA985A-P
Q304	8-729-320-03	TRANSISTOR 2SC2921M-O
Q305	8-729-320-01	TRANSISTOR 2SA1215M-O
Q306	8-729-204-91	TRANSISTOR 2SA1049
Q351	8-729-203-45	TRANSISTOR 2SC3423-O
Q352	8-729-127-53	TRANSISTOR 2SC2275-P
Q353	8-729-190-53	TRANSISTOR 2SA985A-P
Q354	8-729-320-03	TRANSISTOR 2SC2921M-O
Q355	8-729-320-01	TRANSISTOR 2SA1215M-O
Q356	8-729-204-91	TRANSISTOR 2SA1049
<b>RESISTOR</b>		
R101	1-247-713-11	(WG)....CARBON 1K 5% 1/4W
R102	1-247-713-11	CARBON 1K 5% 1/4W
R103	1-247-725-11	CARBON 10K 5% 1/4W
R104	1-249-583-11	CARBON 20K 5% 1/4W
R105	1-247-704-11	CARBON 220 5% 1/4W
R106	1-249-469-11	CARBON 100K 5% 1/4W
R107	1-247-725-11	CARBON 10K 5% 1/4W
R151	1-247-713-11	(WG)....CARBON 1K 5% 1/4W
R214	1-247-693-11	CARBON 27 5% 1/4W
R215	1-247-229-00	CARBON 360 5% 1/2W

Ref.No	Part No.	Description
R216	1-247-229-00	CARBON 360 5% 1/2W
R217	1-247-237-00	CARBON 750 5% 1/2W
R218	1-249-462-11	CARBON 22K 5% 1/4W
R219	1-249-465-11	CARBON 47K 5% 1/4W
R221	1-247-717-11	CARBON 2.2K 5% 1/4W
R222	1-247-237-00	CARBON 750 5% 1/2W
R223	1-249-465-11	CARBON 47K 5% 1/4W
R224	1-247-721-11	CARBON 4.7K 5% 1/4W
R225	1-247-744-11	CARBON 270 5% 1/2W
R227	1-247-747-11	CARBON 470 5% 1/2W
R228	1-247-747-11	CARBON 470 5% 1/2W
R229	1-247-703-11	CARBON 180 5% 1/4W
R230	1-247-747-11	CARBON 470 5% 1/2W
R231	1-247-747-11	CARBON 470 5% 1/2W
R232	1-247-725-11	CARBON 10K 5% 1/4W
R301	1-247-713-11	CARBON 1K 5% 1/4W
R302	1-249-599-11	CARBON 91K 5% 1/4W
R303	1-249-797-11	CARBON 620 1% 1/2W
R304	△ 1-247-713-11	CARBON 1K 5% 1/4W
R305	△ 1-247-707-11	CARBON 390 5% 1/4W
R306	△ 1-219-030-11	FUSIBLE 220 5% 1/2W
R307	△ 1-217-989-11	FUSIBLE 4.7 5% 1/2W
R308	△ 1-217-989-11	FUSIBLE 4.7 5% 1/2W
R309	1-217-611-00	METAL PLATE 0.1 1W
R310	1-217-611-00	METAL PLATE 0.1 1W
R311	△ 1-247-717-11	CARBON 2.2K 5% 1/4W
R312	1-249-460-11	CARBON 15K 5% 1/4W
R313	△ 1-219-002-11	FUSIBLE 15 5% 1/2W
R314	△ 1-219-002-11	FUSIBLE 15 5% 1/2W
R315	1-247-891-00	CARBON 330K 5% 1/4W
R316	1-247-725-11	CARBON 10K 5% 1/4W
R317	1-247-887-00	CARBON 220K 5% 1/4W
R318	1-247-885-00	CARBON 180K 5% 1/4W
R319	1-249-461-11	CARBON 18K 5% 1/4W
R320	1-247-721-11	CARBON 4.7K 5% 1/4W
R321	1-249-462-11	CARBON 22K 5% 1/4W
R323	△ 1-212-849-00	FUSIBLE 4.7 5% 1/4W
R324	1-247-727-11	CARBON 10 5% 1/2W
R326	1-249-850-11	CARBON 100K 1% 1/2W
R327	1-247-708-11	CARBON 470 5% 1/4W
R330	1-247-727-11	(WG)....CARBON 10 5% 1/2W
R331	1-247-727-11	(WG)....CARBON 10 5% 1/2W
R333	1-247-688-11	(WG)....CARBON 10 5% 1/4W
R351	1-247-713-11	CARBON 1K 5% 1/4W
R352	1-249-599-11	CARBON 91K 5% 1/4W
R353	1-249-797-11	CARBON 620 1% 1/2W
R354	△ 1-247-713-11	CARBON 1K 5% 1/4W
R355	△ 1-247-707-11	CARBON 390 5% 1/4W
R356	△ 1-219-030-11	FUSIBLE 220 5% 1/2W
R357	△ 1-217-989-11	FUSIBLE 4.7 5% 1/2W
R358	△ 1-217-989-11	FUSIBLE 4.7 5% 1/2W
R359	1-217-611-00	METAL PLATE 0.1 1W
R360	1-217-611-00	METAL PLATE 0.1 1W
R361	△ 1-247-717-11	CARBON 2.2K 5% 1/4W
R362	1-249-460-11	CARBON 15K 5% 1/4W
R363	△ 1-219-002-11	FUSIBLE 15 5% 1/2W
R364	△ 1-219-002-11	FUSIBLE 15 5% 1/2W
R365	1-247-887-00	CARBON 220K 5% 1/4W
R374	1-247-727-11	CARBON 10 5% 1/2W
R376	1-249-850-11	CARBON 100K 1% 1/2W
R377	1-247-708-11	CARBON 470 5% 1/4W
R380	1-247-727-11	(WG)....CARBON 10 5% 1/2W

**Note:**  
The components identified by mark △ or dotted line with mark △ are critical for safety. Replace only with part number specified.

**Note:**  
Les composants identifiés par une marque △ sont critiques pour la sécurité. Ne les remplacer que par une pièce portant le numéro spécifié.

<u>Ref.No</u>	<u>Part No.</u>	<u>Description</u>				
R381	1-247-727-11	(WG)... CARBON 10	5%	1/2W		
R401	△ 1-215-920-11	METAL OXIDE	3.3K	5%	3W	F
R402	△ 1-215-920-11	METAL OXIDE	3.3K	5%	3W	F
RT301	1-237-455-11	RES. ADJ. CARBON	500			
RT351	1-237-455-11	RES. ADJ. CARBON	500			
RV301	1-238-656-11	RES. VAR. CARBON 20K/20K (ATTENUATOR)				
RY301	1-515-676-11	RELAY				
RY302	1-515-676-11	RELAY				
S1	△ 1-554-538-00	SWITCH, PUSH (AC POWER)(1 KEY)				
S101	1-572-010-11	SWITCH, SLIDE (INPUT OPERATION)				
S201	1-572-008-11	SWITCH, ROTARY (SPEAKERS)				
S501	1-572-009-11	(E)...SELECTOR, VOLTAGE				
T1	△ 1-449-787-11	(AEP, WG)... TRANSFORMER, POWER				
T1	△ 1-449-789-11	(UK)... TRANSFORMER, POWER				
T1	△ 1-449-790-11	(US, Canadian)... TRANSFORMER, POWER				
T1	△ 1-449-788-11	(E)... TRANSFORMER, POWER				
TM301	1-537-246-11	(US, Canadian, E, AE1, UK) ... TERMINAL BOARD (SPEAKER)				
TM301	1-537-246-31	(WG)... TERMINAL BOARD (SPEAKER)				
TM301	1-537-246-21	(AE2)... TERMINAL BOARD (SPEAKER)				

**ACCESSORIES AND PACKING MATERIALS**  
\*\*\*\*\*

*2-135-414-01	SHEET, PROTECTION
3-703-450-11	(US)... INSTRUCTION
3-750-794-11	(US, Canadian, E, AE1, UK) ...MANUAL, INSTRUCTION
3-750-794-42	(AE2, WG)...MANUAL, INSTRUCTION
4-847-802-00	SCREW
*4-933-001-01	CUSHION
*4-933-003-01	(E)...INDIVIDUAL CARTON
*4-933-004-01	(EXCEPT FOR E)...INDIVIDUAL CARTON

<p><b>Note:</b> The components identified by mark △ or dotted line with mark △ are critical for safety. Replace only with part number specified.</p>	<p><b>Note:</b> Les composants identifiés par une marque △ sont critiques pour la sécurité. Ne les remplacer que par une pièce portant le numéro spécifié.</p>
--	--