

TC-K81

US Model
 Canadian Model
 AEP Model
 UK Model
 E Model

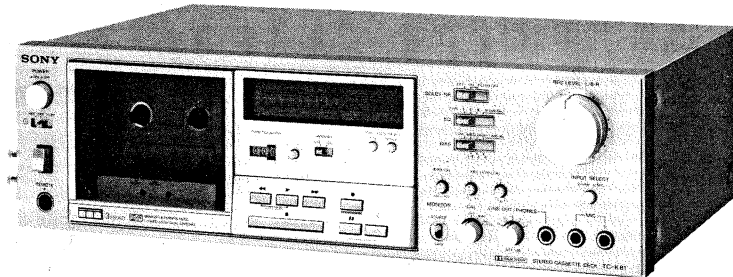

Photo: AEP, UK, US, E model

'Dolby' and the double-D symbol are the trade marks of Dolby Laboratories. Noise reduction system manufactured under license from Dolby Laboratories.

STEREO CASSETTE DECK

SPECIFICATIONS

GENERAL

Power Requirements: AEP model
 220V ac ~, 50/60 Hz
 (240V ac ~ adjustable by authorized Sony personnel)
 UK model
 240V ac ~, 50/60 Hz
 (220V ac ~ adjustable by authorized Sony personnel)
 US, Canadian model
 120V ac, 60 Hz
 E model
 110, 120, 220 or 240V ac ~,
 50/60 Hz

Power Consumption: 28W (AEP, UK, E model)
 26W (US, Canadian model)

Dimensions: Approx. 430(w) x 130(h) x 290(d) mm
 17(w) x 5¹/₈(h) x 11¹/₂(d) inches
 (AEP, UK, US, E model)
 Approx. 460(w) x 130(h) x 290(d) mm
 18¹/₈(w) x 5¹/₈(h) x 11¹/₂(d) inches
 (Canadian model)
 including projecting parts and controls

Weight: Approx. 6.3kg, 13 lb 14 oz (AEP, UK, US, E model)
 Approx. 7kg, 15 lb 7 oz (Canadian model)

— Continued on page 2 —

SAFETY RELATED COMPONENT WARNING!!

COMPONENTS IDENTIFIED BY SHADING AND MARK  ON THE SCHEMATIC DIAGRAMS, EXPLODED VIEWS AND IN THE PARTS LIST ARE CRITICAL TO SAFE OPERATION. REPLACE THESE COMPONENTS WITH SONY PARTS WHOSE PART NUMBERS APPEAR AS SHOWN IN THIS MANUAL OR IN SUPPLEMENTS PUBLISHED BY SONY.

ATTENTION AU COMPOSANT AYANT RAPPORT À LA SÉCURITÉ!

LES COMPOSANTS IDENTIFIÉS PAR UNE TRAME ET UNE MARQUE  SUR LES DIAGRAMMES SCHEMATIQUES, LES VUES EXPLOSÉES ET LA LISTE DES PIÈCES SONT CRITIQUES POUR LA SÉCURITÉ DE FONCTIONNEMENT. NE REMPLACER CES COMPOSANTS QUE PAR DES PIÈCES SONY DONT LES NUMÉROS SONT DONNÉS DANS CE MANUEL OU DANS LES SUPPLÉMENTS PUBLIÉS PAR SONY.

Tape Transport Mechanism Type	TCM-100V2	
	Specification	Test Equipment
Forward Torque	28–43 g·cm (0.39–0.59 oz·inch)	Sony torque meter CO-102C
Back Tension Torque	2.5–4.5 g·cm (0.04–0.06 oz·inch)	Sony torque meter CO-102C
Pinch Roller Pressure	<ul style="list-style-type: none"> • Take-up Side 280–380 g (10–13 oz) • Supply Side 180–280 g (7–10 oz) 	Spring scale or tension gauge

SONY

SERVICE MANUAL

TAPE RECORDER SECTION

Recording System: 4-track 2-channel stereo

Fast-forward and Rewind Time: Approx. 80 sec. (with C-60)

Frequency Response: DOLBY NR OFF
 AEP, UK, E model

- With TYPE IV cassette (Sony METALLIC)
 - 20–20,000 Hz
 - 30–18,000 Hz (± 3 dB)
 - 30–13,000 Hz (± 3 dB, 0 VU recording)
 - 30–18,000 Hz (DIN)
- With TYPE III cassette (Sony Fe-Cr)
 - 20–20,000 Hz
 - 30–18,000 Hz (± 3 dB)
 - 30–18,000 Hz (DIN)
- With TYPE II cassette (Sony CD- α)
 - 20–19,000 Hz
 - 30–17,000 Hz (± 3 dB)
 - 30–17,000 Hz (DIN)
- With TYPE I cassette (Sony BHF)
 - 20–17,000 Hz
 - 30–15,000 Hz (± 3 dB)
 - 30–15,000 Hz (DIN)

US, Canadian model

- With TYPE IV cassette (Sony METALLIC)
 - 20–20,000 Hz
 - 30–18,000 Hz (± 3 dB)
 - 30–13,000 Hz (± 3 dB, 0 VU recording)
- With TYPE III cassette (Sony Fe-Cr)
 - 20–20,000 Hz
 - 30–18,000 Hz (± 3 dB)
- With TYPE II cassette (Sony EHF)
 - 20–19,000 Hz
 - 30–17,000 Hz (± 3 dB)
- With TYPE I cassette (Sony HFX)
 - 20–17,000 Hz
 - 30–15,000 Hz (± 3 dB)

Wow and Flutter: 0.04% WRMS (NAB) } (AEP, UK, E model)
 $\pm 0.12\%$ (DIN)

0.04% WRMS (US, Canadian model)

S/N Ratio: DOLBY NR OFF
 AEP, UK, E model

- With TYPE III cassette (Sony Fe-Cr)
 - 60 dB at peak level (NAB)
 - 59 dB (DIN, 1975, rev.)
- With TYPE II cassette (Sony CD- α)
 - 58 dB at peak level (NAB)

US, Canadian model

- With TYPE III cassette (Sony Fe-Cr)
 - 60 dB at peak level
- With TYPE II cassette (Sony EHF)
 - 58 dB at peak level

DOLBY NR ON
 Improved by 5 dB at 1 kHz, 10 dB above 5 kHz

Total Harmonic Distortion: 0.8% (with Sony Fe-Cr cassette)

Bias Frequency: 105 kHz

Inputs: Microphone inputs (phone jacks) . . . 2
 sensitivity 0.25 mV (-70 dB)
 for a low-impedance microphone

Line inputs (phono jacks) 2
 sensitivity 77.5 mV (-20 dB)
 input impedance 50 k Ω

Outputs: Variable line outputs (phono jacks) . 2
 maximum output level 0.435 V (-5 dB)
 at load impedance 50 k Ω
 with LINE OUT level control at "0"
 variable range of output level
 -5 to -29 dB (5 steps)
 suitable load impedance more than
 10k Ω

Fixed line outputs (phono jacks) . . . 2
 output level 0.435 V (-5 dB)
 at load impedance 50 k Ω
 Suitable load impedance
 more than 10 k Ω

Headphone output 1
 variable range of output level
 -20 to -44 dB (5 steps)
 at load impedance 8 Ω

0 dB = 0.775 V

LED PEAK PROGRAM METERS

Response Range: -40 dB to $+8$ dB

Frequency Response: 20 Hz $-20,000$ Hz ± 1.5 dB

Response Time: 1 millisecond

Decay Time
(from 0 dB to -20 dB): 750 milliseconds

Overshoot: None

Indicator Elements: 16 elements for each channel

SERVICING NOTE

When the top cover is removed, the internal photo transistor may pick up stray light and shut the set off.

MODEL IDENTIFICATION

— Specification Label —

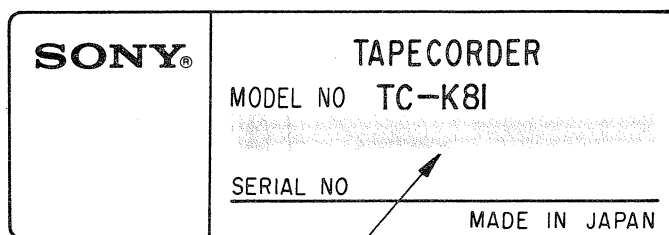

US, Canadian Model: AC 120V 60Hz 26W
AEP model: AC 220V~ 50/60Hz 28W
UK model: AC 240V~ 50/60Hz 28W
E model: AC 110, 120, 220, 240V~ 50/60Hz 28W

— Power Cord —

E model: euro-plug 1-534-817-XX

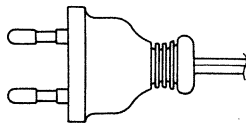

E model: parallel-blade plug 1-551-473-31

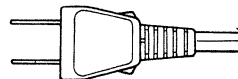

Handling Precautions for MOS ICs

Generally, the insulation resistance of the oxide layer in MOS IC structures is very high, and the oxide layer is very thin. Because of this, it is possible that the static voltages usually present on clothes and the human body will be enough to generate a potential difference across the insulator, high enough to cause a breakdown of the insulating layer.

The following precautions should be taken while handling these ICs.

(Particular care should be taken under conditions of low humidity.)

Precautions in Replacing MOS ICs

1. Store new ICs by inserting them into a urethane-polyester cushion (which is somewhat conductive), or wrapping it in aluminum foil, so that all the pins are at the same potential. (The ICs should be stored in that manner until mounted on the circuit board.)

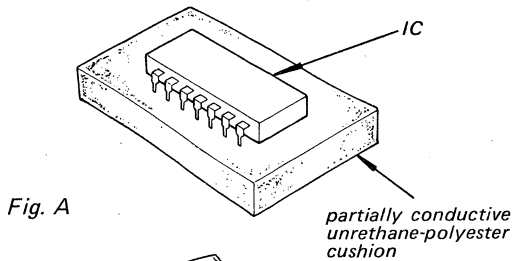

Fig. A

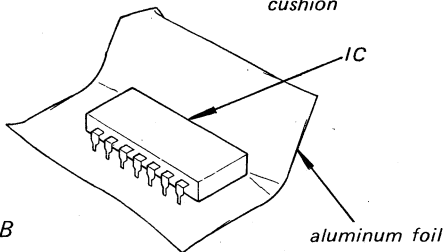

Fig. B

2. Check the soldering iron for possible power-line leakage current. Make sure that there is no leakage path by connecting an ohmmeter to the tip of the soldering iron and the plug as shown in Fig. C. If there is a leakage path, use some other soldering iron.

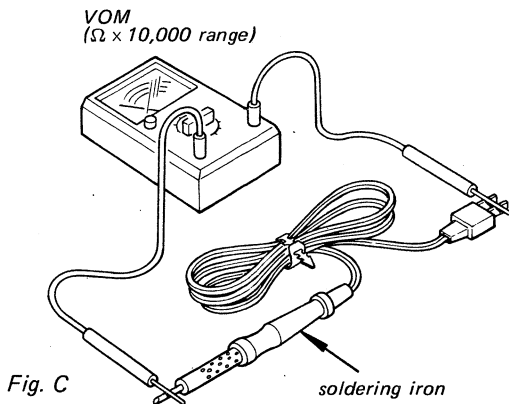

Fig. C

3. Equalize any potential difference between the clothes, the tools in use, the work bench, the set being worked on, and the packaged IC by touching them all in succession with the hands or a conductive wire or tool.
4. The following are effective methods for handling ICs that remove the potential difference across the oxide layer.
 - Use a paper clip modified by soldering in a wire braid insert.

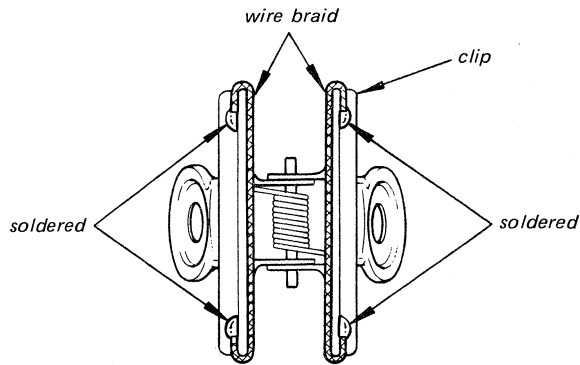

Fig. D

Make sure that there is no solder on the inside.

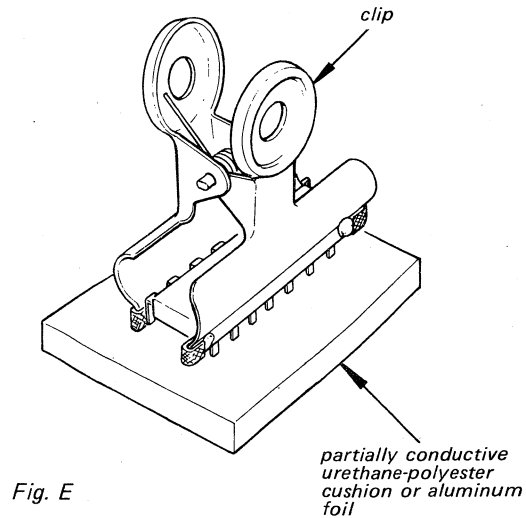

Fig. E

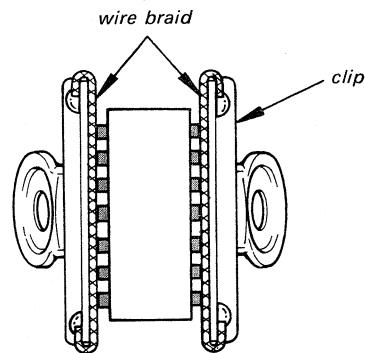

Fig. F

Make sure that all the pins are in contact with the wire braid (all the pins will then be at the same potential.).

- Take a short length of fine bare wire and wind it around the IC so that it shorts all the pins of the IC, while it is still in the urethane-polyester cushion or aluminum foil. This ensures that all the pins are at the same potential.

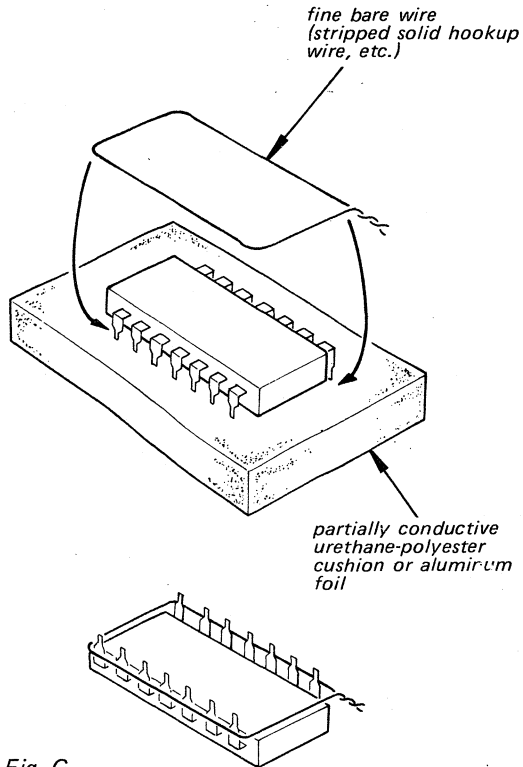

Fig. G

- When it is necessary to handle the IC with the fingers, do not touch any pin, and hold the IC at the ends of its plastic-package case as shown in Fig. H.

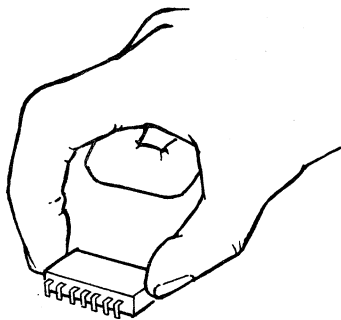

Fig. H

5. Method of Mounting

Insert the IC while holding it with the modified clip, and solder all the pins with the clip still shorting the pins. (Similarly, solder all the pins while the bare shorting wire is still wound around them.). Remove the clip or the bare shorting wire only after all the pins have been soldered.

Precaution while Checking C-MOS ICs

The C-MOS ICs (Complementary MOS) are MOS ICs that have their output sections made up of N-channel and P-channel push-pull stages to increase their speed of operation. If the output terminal of these ICs comes into contact with B+ or B- voltage, then the FET which is ON at that time will either become shorted or open.

This is valid for all the output sections that are connected together by the interconnections. Even the circuits that are physically separated (and not on the same board) can be destroyed simultaneously.

Example:

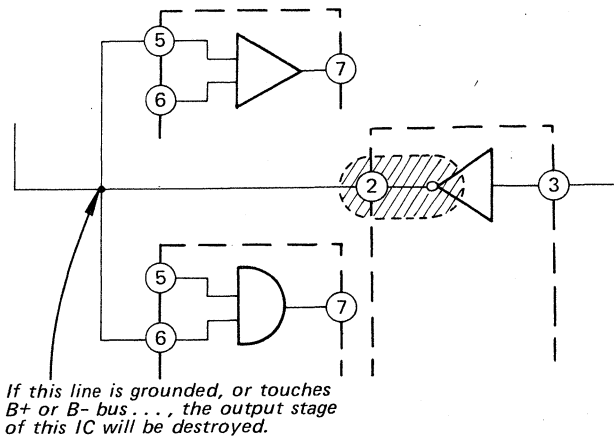
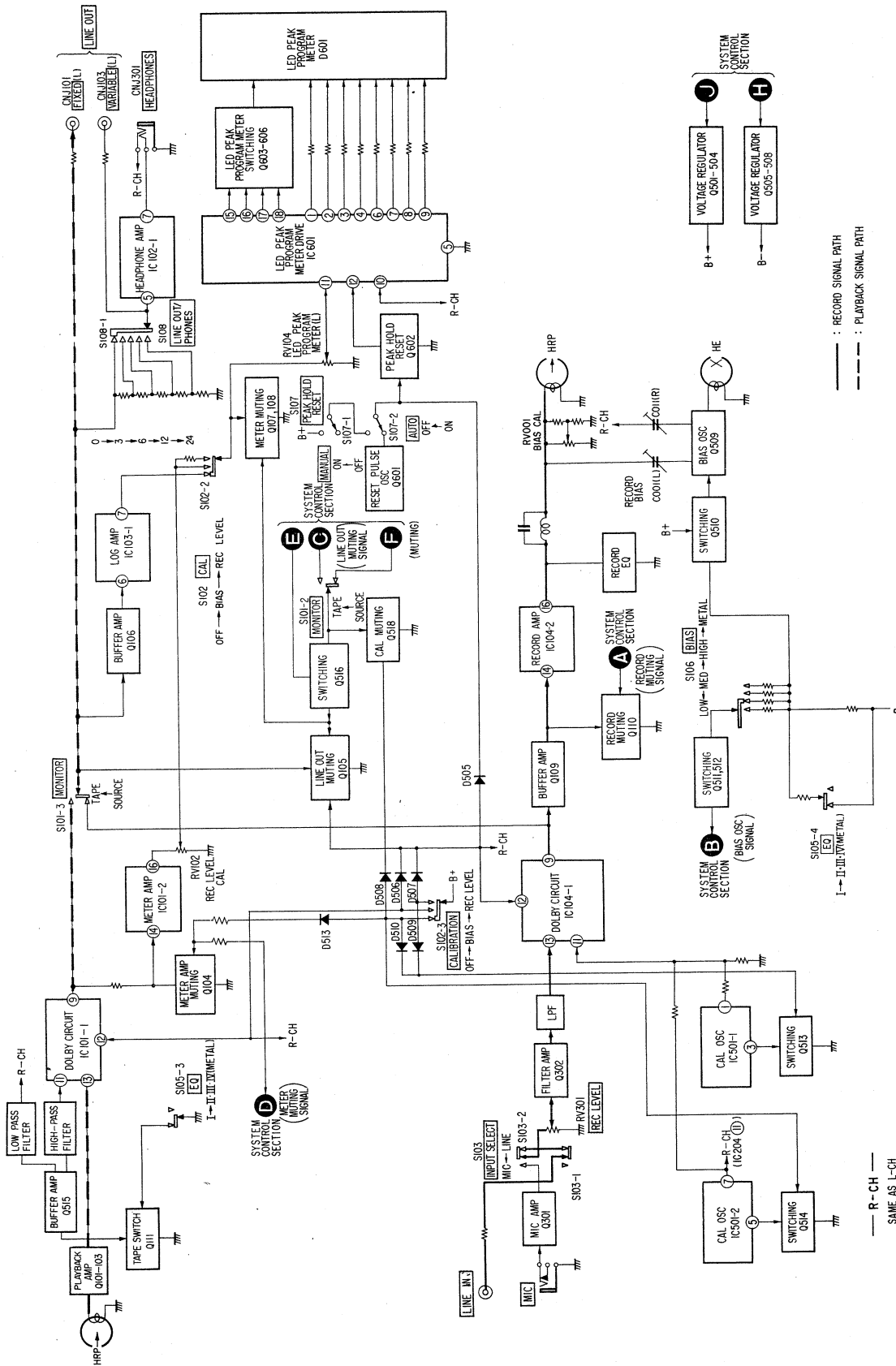

Fig. I

SECTION 1
OUTLINE

1-1. BLOCK DIAGRAM - Audio Amp Section -



SECTION 2
DISASSEMBLY

— System Control Section —

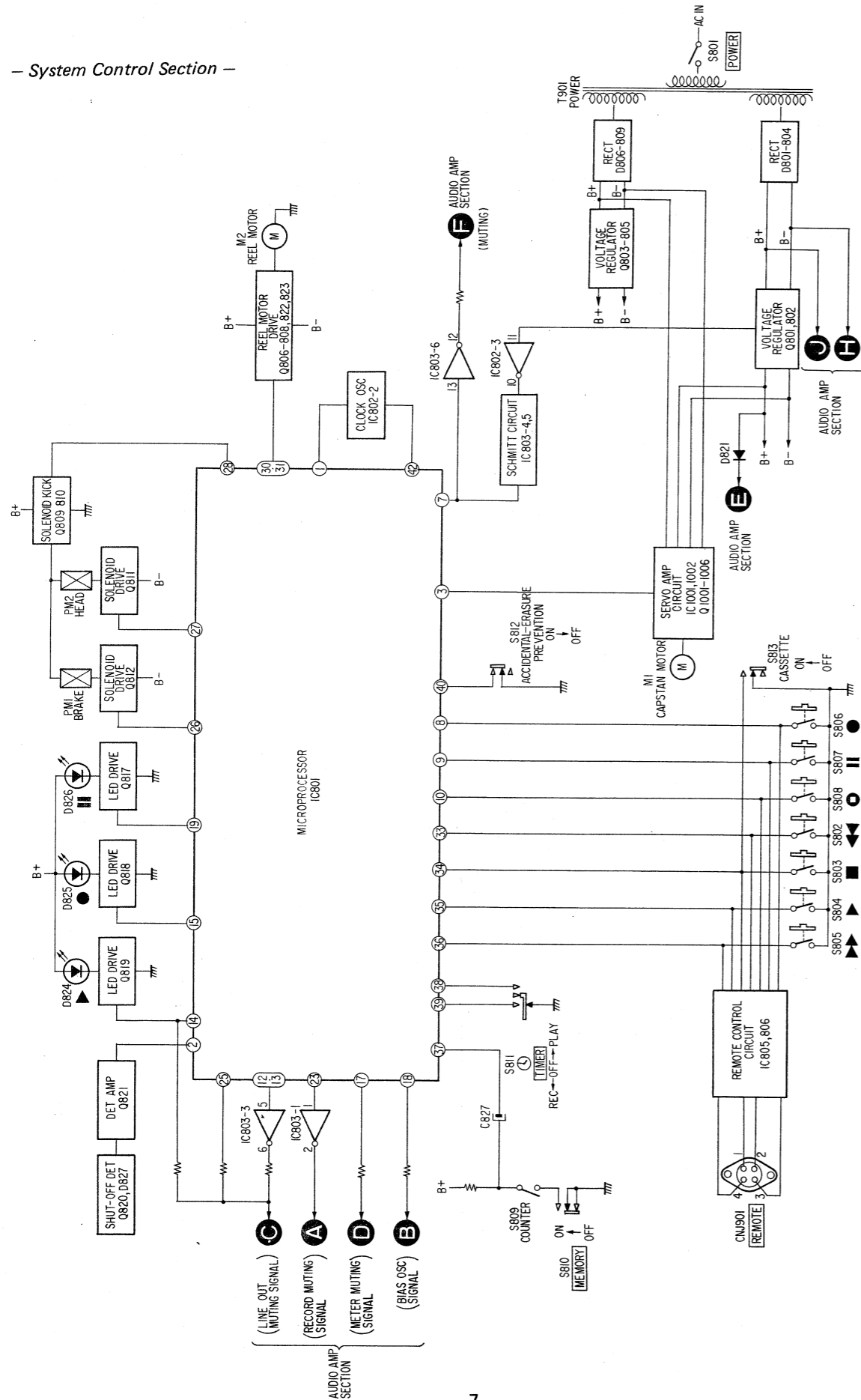

• Follow the disassembly procedure in the numerical order given.

TOP COVER/FRONT PANEL/BOTTOM PLATE REMOVAL

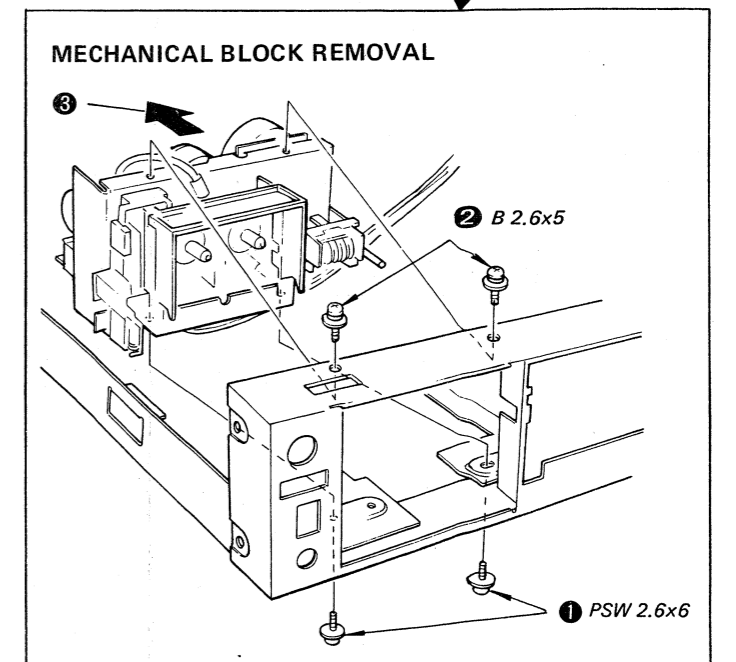
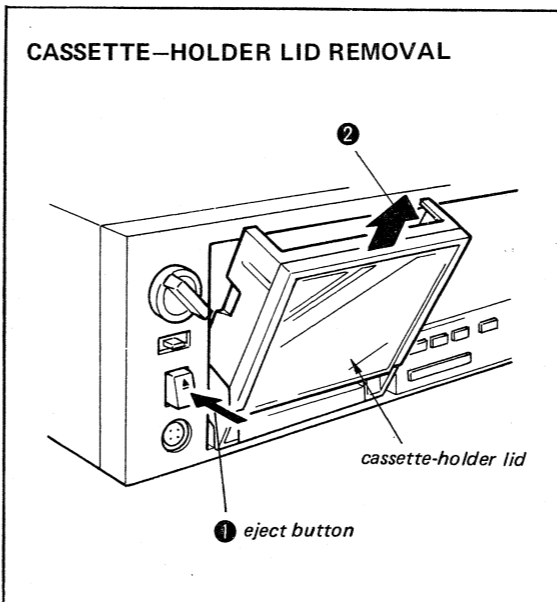
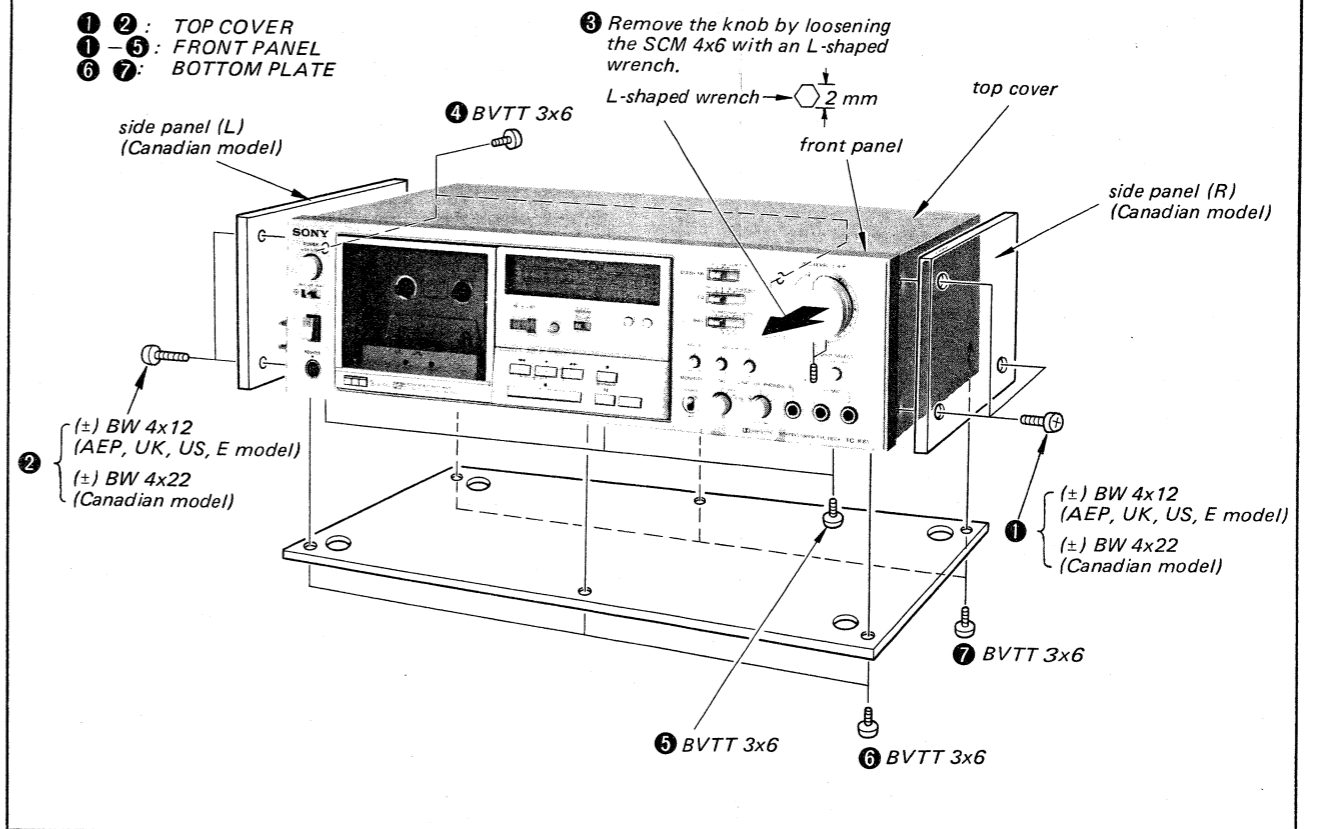

SECTION 3
ADJUSTMENTS

3-1. MECHANICAL ADJUSTMENTS

PRECAUTION

- Clean the following parts with a denatured-alcohol-moistened swab:

record/playback head	pinch rollers
erase head	rubber belts
capstans	idlers
- Demagnetize the record/playback head with a head demagnetizer.
- Do not use a magnetized screwdriver for the adjustments.
- After the adjustments, apply suitable locking compound to the parts adjusted.
- The adjustments should be performed with the rated power supply voltage unless otherwise noted.

Torque Measurement and Back Tension Torque Adjustment

1.	Torque	Torque meter	Meter reading
	Forward	CQ-102C	28-43 g · cm (0.39-0.59 oz · inch)
	Back tension	CQ-102C	2.5-4.5 g · cm (0.04-0.06 oz · inch)

- If the specified back-tension torque is not obtained, change the hooking position.

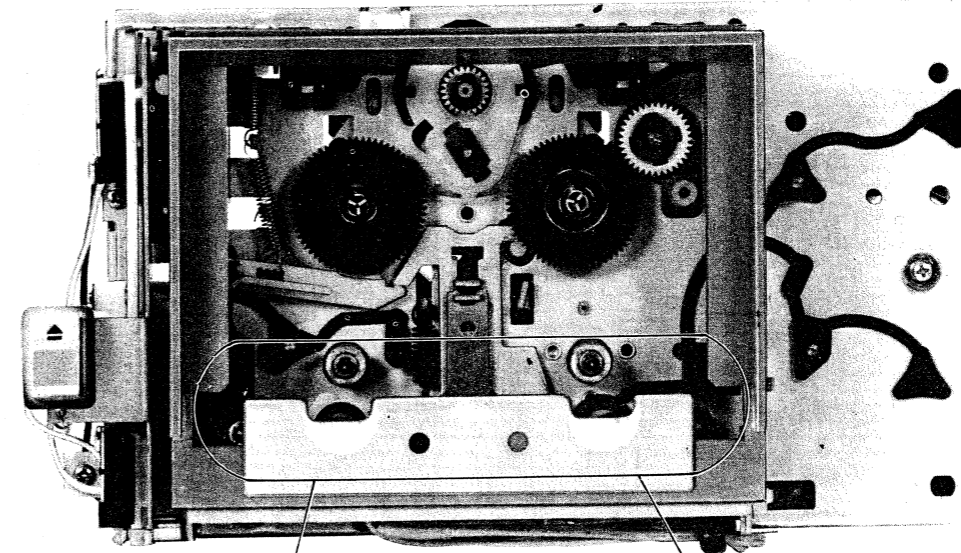
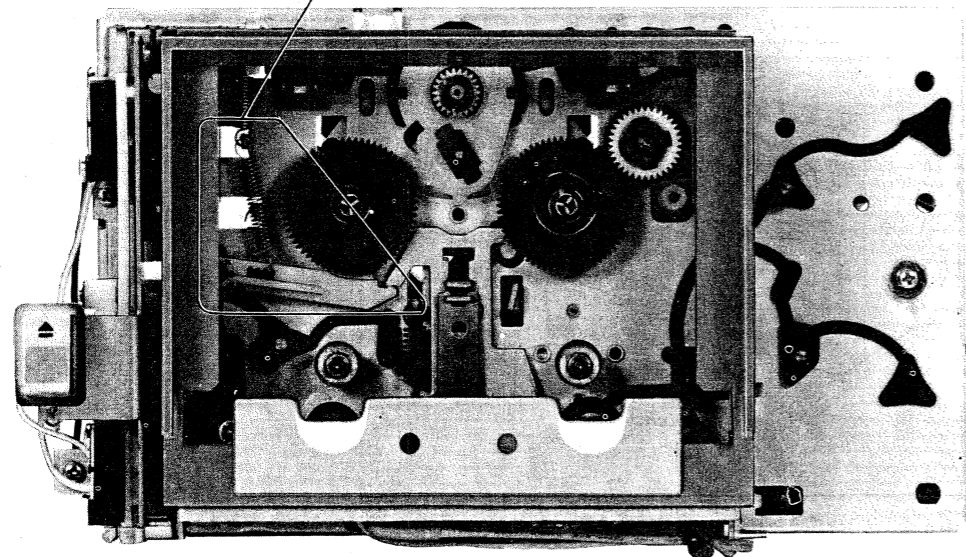
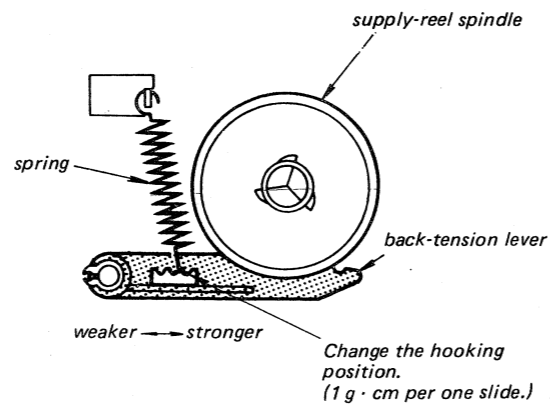

Head Height Adjustment

- Prepare an adjustment cassette as shown below.

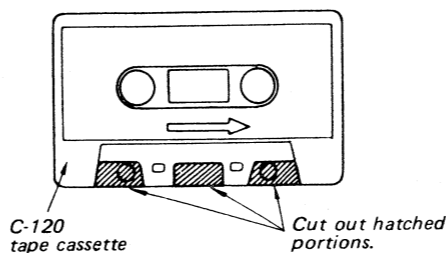

- In playback mode and viewing from the front, adjust the head heights to eliminate tape curl and tape twist at portions shown by arrows.

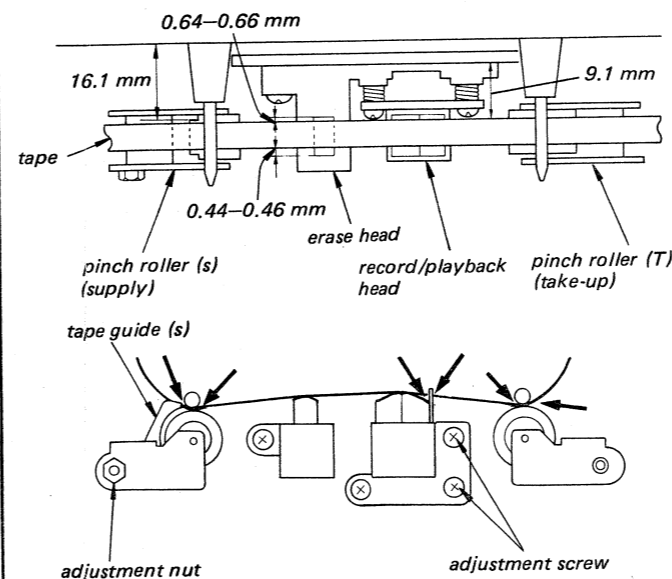

Pinch Roller Pressure Measurement
- Forward Mode -

-

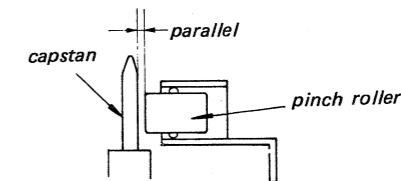

- Slowly pull the pinch roller and read the spring scale or the tension gauge just when the pinch roller stops rotating.

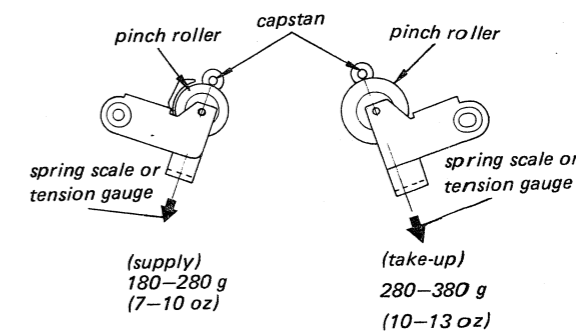

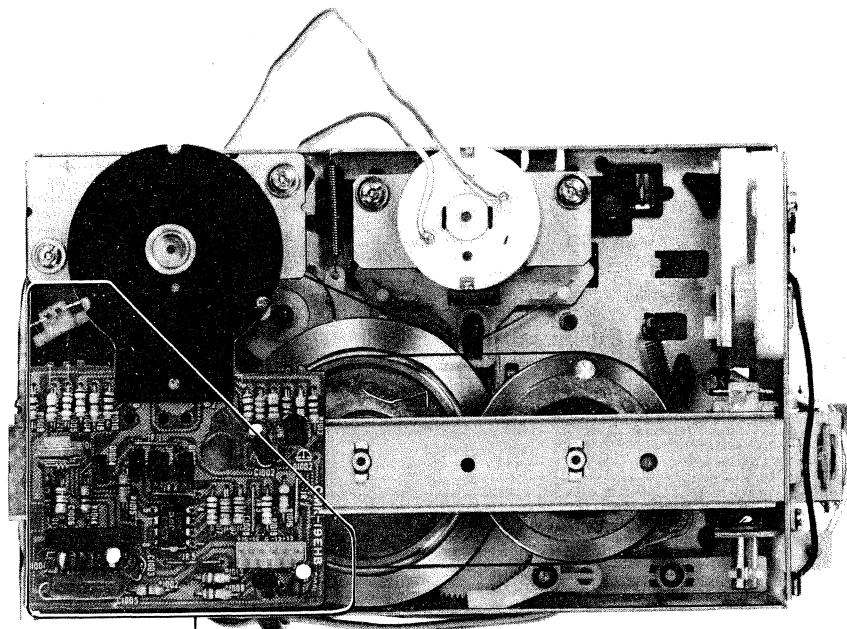

Brake Solenoid (PM1) Position Adjustment

— Stop Mode —

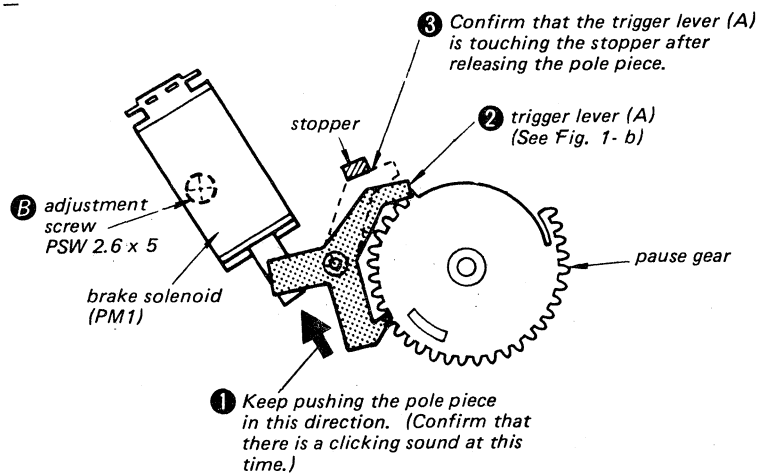

Fig. 1- a

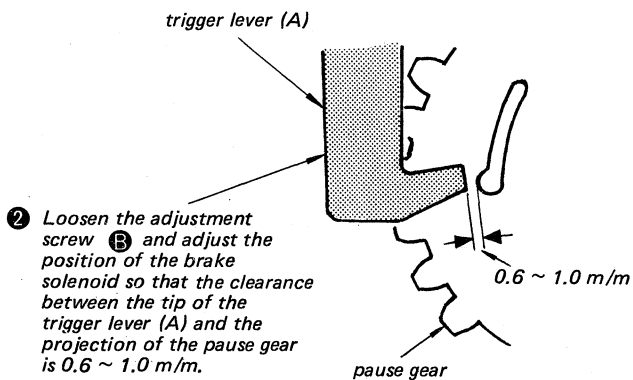
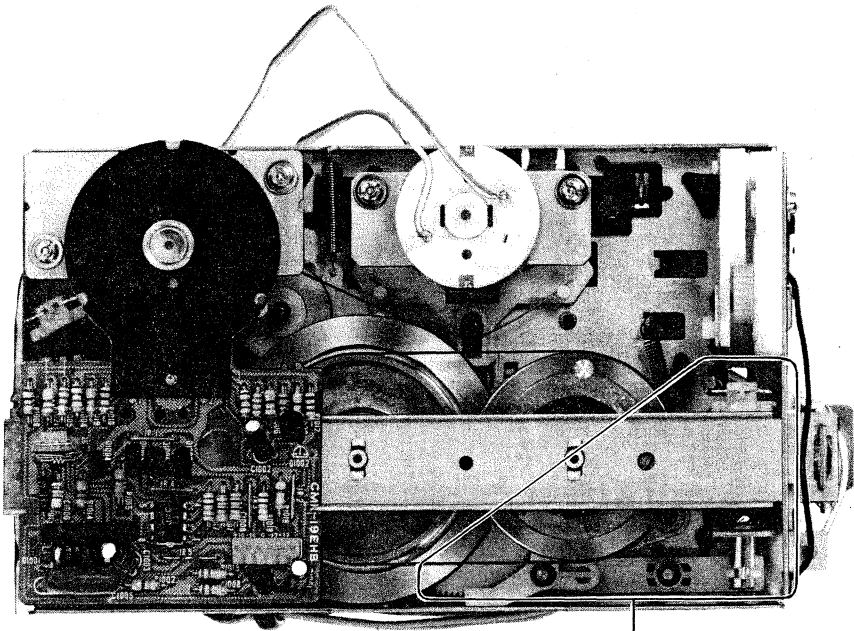

Fig. 1- b



Head Solenoid (PM2) Position Adjustment

– Stop Mode –

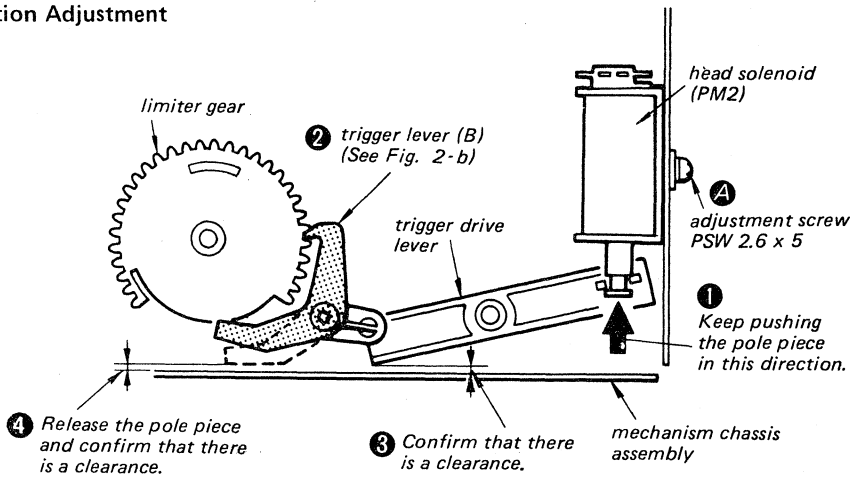

Fig. 2-a

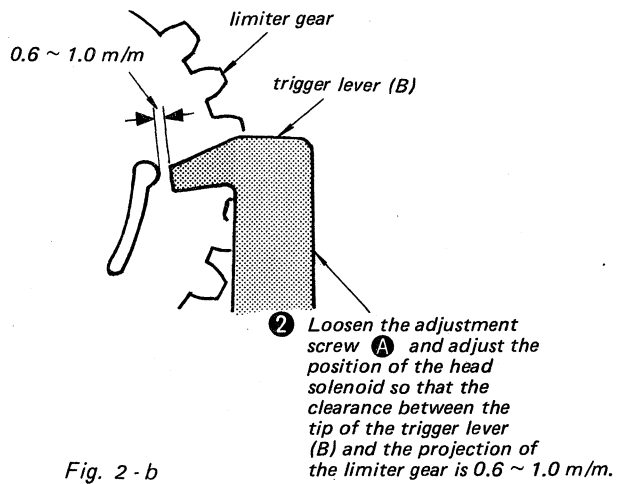

Fig. 2-b

3-2. ELECTRICAL ADJUSTMENTS

Note: The adjustment should be performed in the order given in this service manual. The adjustments should be performed for both L-CH and R-CH.

- Set the BIAS and EQ switches according to the tape as follows.

Tape	BIAS switch	EQ switch
CS-10	MED	TYPE I
CS-25	HIGH	TYPE II
CS-30	MED	TYPE III
CS-40	METAL	TYPE IV

- Switches and controls should be set as follows unless otherwise specified.

DOLBY NR switch: OFF
 EQ switch: TYPE I
 BIAS switch: MED
 MONITOR: TAPE
 CALIBRATION: OFF
 INPUT SELECT: LINE

- Standard Record:

Deliver the standard input signal level to the input jack and set the REC LEVEL control to obtain the standard output signal level.

Standard Input Level

	MIC	LINE IN
source impedance	300 Ω	10 kΩ
input level	0.77 mV (-60 dB)	0.25 V (-10 dB)

Standard Output Level

	LINE OUT (FIXED)	HEAD-PHONES
load impedance	47 kΩ	8 Ω
output level	0.44 V (-5 dB)	77 mV* (-20 dB)

* with HEADPHONES/LINE OUT level control at "10".

Record/playback Head Azimuth Adjustment

Procedure:

- Mode: playback

test tape P-4-A81 (6.3 kHz, -10 dB)

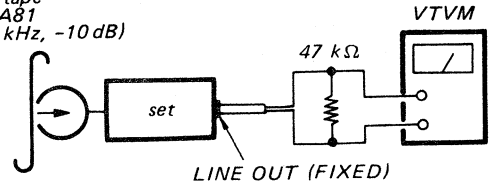

- Turn the adjustment screw for the maximum output levels. If these levels do not match, turn the adjustment screw until both of output levels match together within 0.5 dB.

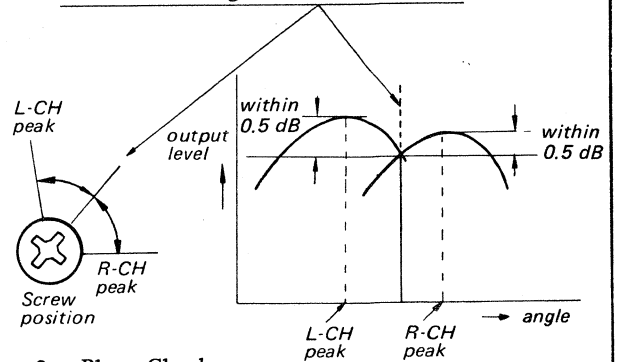

- Phase Check
Mode: playback

test tape P-4-A81 (6.3 kHz, -10 dB)

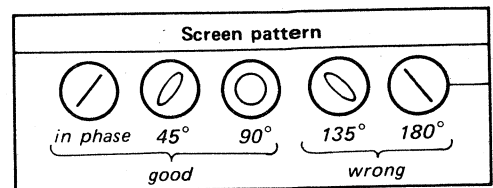
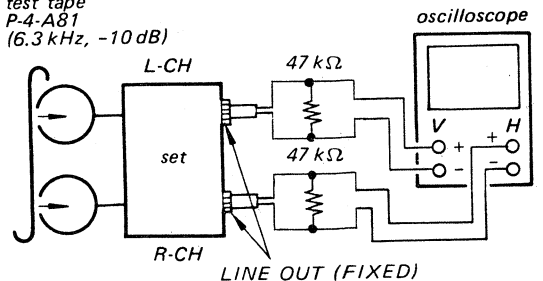

Adjustment Location:



Tape Speed Adjustment

Procedure:

Mode: playback

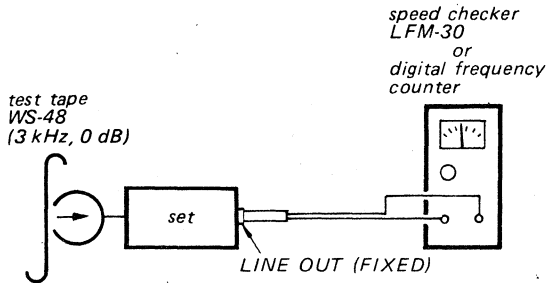

Specification:

Speed checker	Digital frequency counter
-0.7 to +0.7%	2,980 - 3,020 Hz

Frequency difference between the beginning and the end of the tape should be within 0.7% (20 Hz).

Adjustment Location:

- servo amp board -

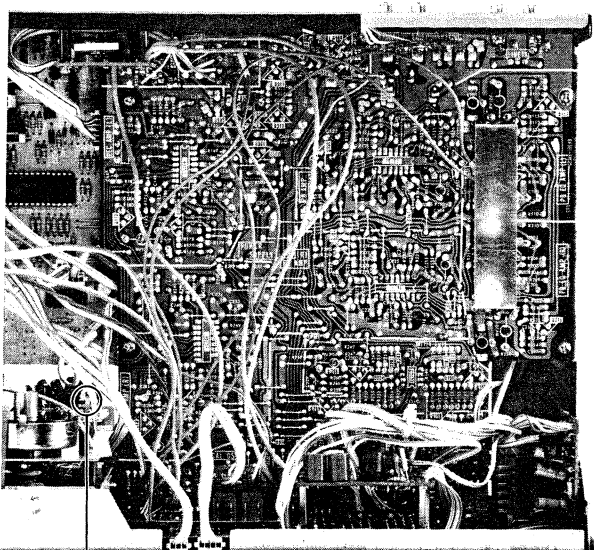

RV1001

Playback Level Adjustment

Procedure:

Mode: playback

test tape
P-4-L81
(333 Hz, 0 dB)

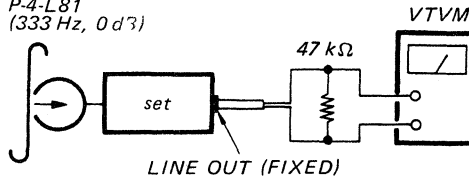

Specification:

LINE OUT level: 0.52 - 0.59 V
(-3.5 to -2.5 dB)

Level difference between channels:
less than 0.5 dB

Check that LINE OUT level does not change in playback mode while changing the mode from playback to stop several times.

Adjustment Location:

- record/playback board -

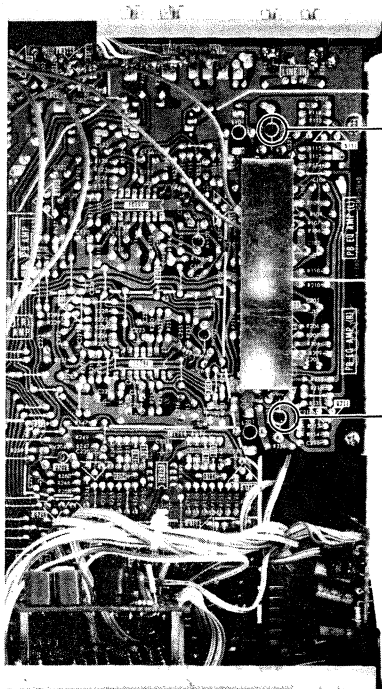

RV101
(L-CH)

RV201
(R-CH)

Bias Trap Adjustment

Procedure:

Mode: record (no-cassette loaded)

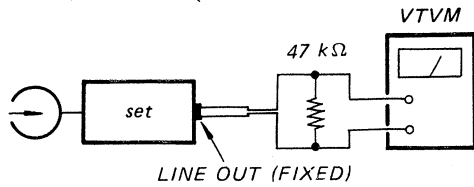

Specification:

LINE OUT level: less than 2.5 mV
(less than -50 dB)

Adjustment Location:

- record/playback board -

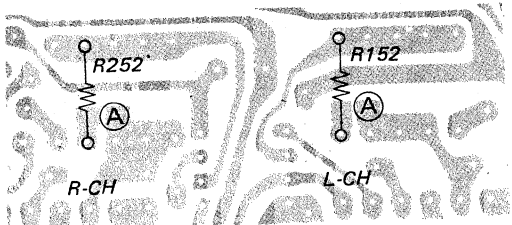
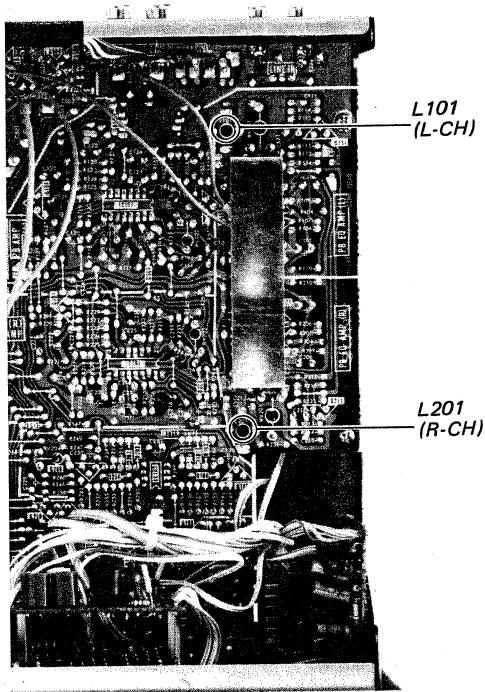

LED Peak Program Meter Calibration

- Setting:

REC LEVEL control: standard record
(See page 13.)

MONITOR switch: SOURCE

Procedure:

Mode: record

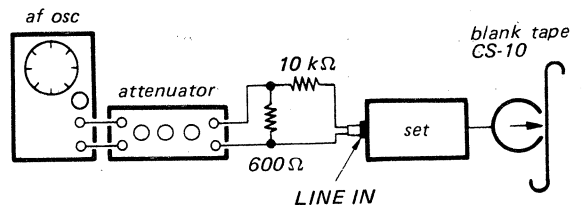

Slowly turn RV104 (L-CH) and RV204 (R-CH) and stop them just when the segments (◻◻ -2 dB) go out.

Specification:

LINE IN level	Indication
0.85 - 1.1 V (+1 to +3 dB)	The first segment from the right lights.
2.7 - 5.5 mV (-49 to -43 dB)	The second segment from the left goes out.

If the second segment from the left does not go out when the 2.7 mV (-49 db) LINE IN signal is applied, solder (A).

Adjustment Location:

- record/playback board -



Record Bias Adjustment

Setting:

REC LEVEL control: standard record
(See page 13.)

Procedure:

1. Mode: record

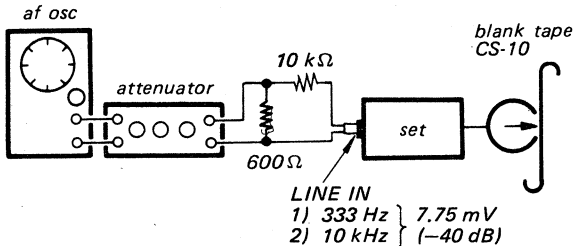

2. Mode: playback

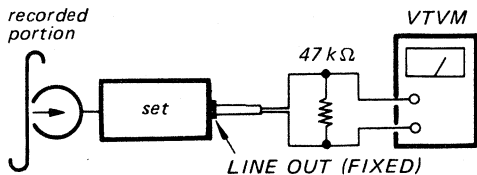

Adjust C001 (L-CH) and C011 (R-CH) so that the 333 Hz and the 10 kHz signal levels become the same.

Adjustment Location:

– bias trimmer board –

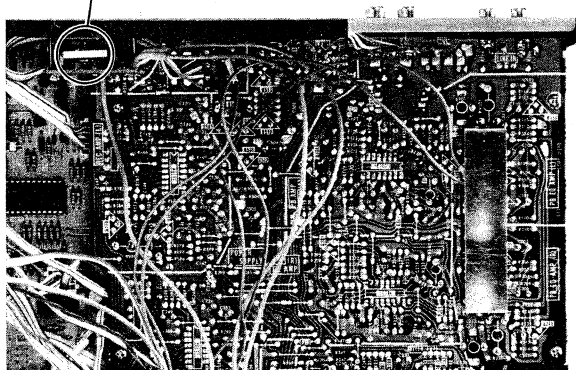
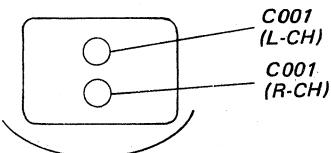

Record Level Adjustment

Setting:

REC LEVEL control: standard record
(See page 13.)

Procedure:

1. Mode: record

blank tape
CS-10
CS-25
CS-30
CS-40

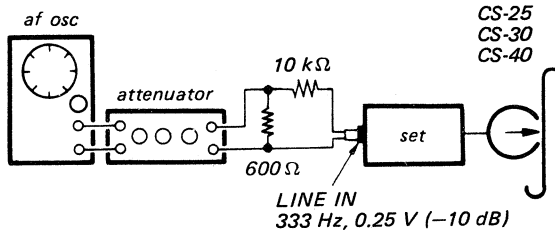

2. Mode: playback

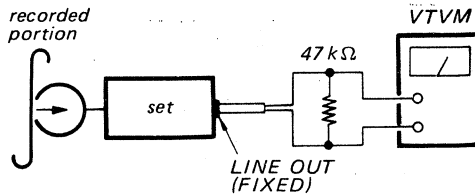

Specification:

Tape	LINE OUT level
CS-10	0.41 – 0.46 V (–5.5 to –4.5 dB)
CS-25 CS-30 CS-40	0.37 – 0.46 V (–6.5 to –4.5 dB)

Adjustment Location:

– record/playback board –

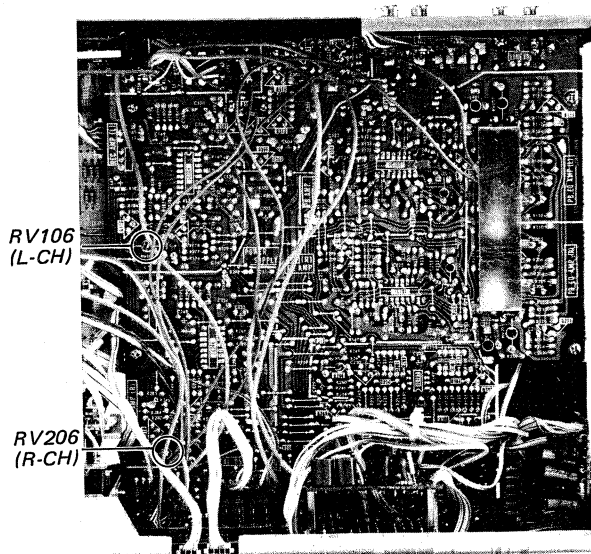

REC LEVEL CAL (calibration) Adjustment

Setting:

CALIBRATION switch: REC LEVEL

Procedure:

1. Unsolder the hatched portion in Fig. 3 before starting the adjustment.
2. Mode: record
MONITOR switch: SOURCE

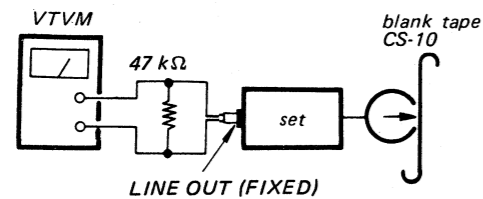

Confirm that the LINE OUT level is 43–45 mV (–25.2 to –24.8 dB).

3. Mode: record and simultaneous playback
MONITOR switch: TAPE

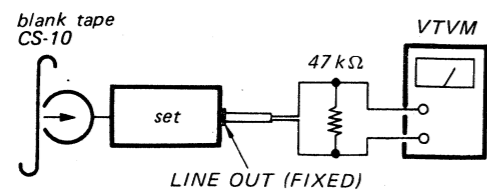

Confirm that the LINE OUT level is 42–47 mV (–25.5 to –24.5 dB).

4. Slowly turn RV102 (L-CH) and RV202 (R-CH) and stop them just when the second RED segments go out.
5. Confirm that the LINE OUT levels vary between 29–66 mV (–28.5 to –21.5 dB) according to the REC LEVEL CAL controls turning.

Adjustment Location

– record/playback board –

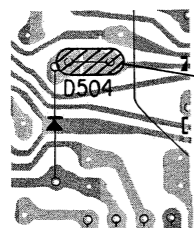

Fig. 3

BIAS CAL (calibration) Measurement

Setting:

CALIBRATION switch: BIAS

Procedure:

1. Unsolder part (A) before starting the adjustment.

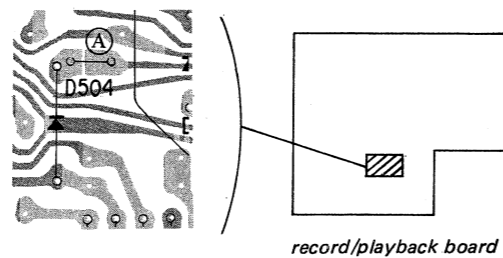

2. Mode: record and simultaneous playback
MONITOR switch: TAPE

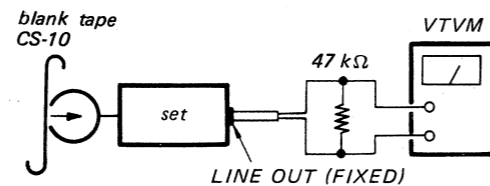

3. Confirm that the LINE OUT level is 26–37 mV (–29.5 to –27.5 dB).

4. Confirm that the LED peak program meter indicates approx. 0 dB, and the LINE OUT levels vary between 18–42mV (–32.5 to –25.5 dB) according to the REC LEVEL CAL controls turning.

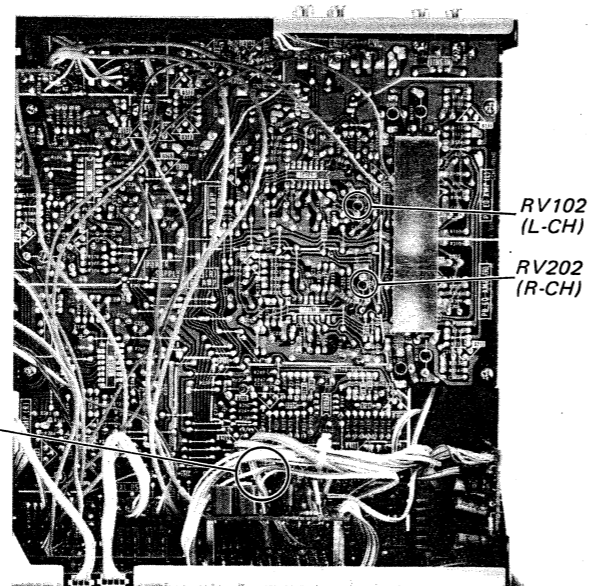





(MEMO)

SECTION 4
DIAGRAMS

[MEMO]

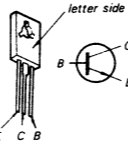
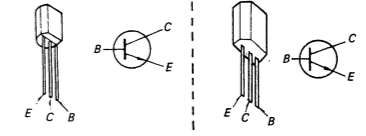
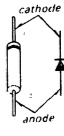
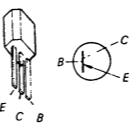
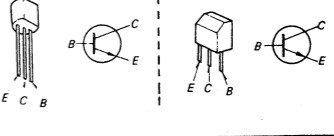
Replacement Semiconductors

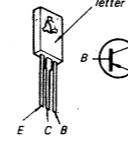
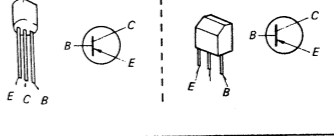
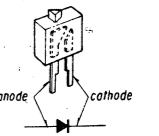
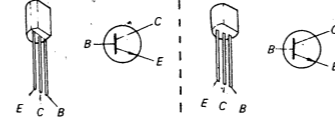
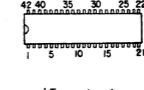
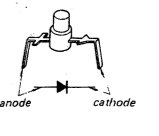
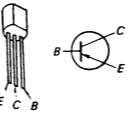
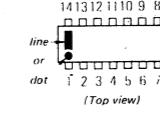
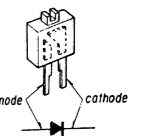
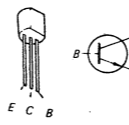
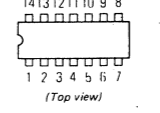
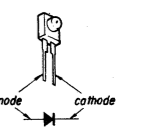
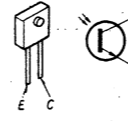
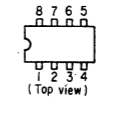
For replacement, use semiconductors except in ().

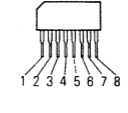
<p>Q801: 2SD809 Q807: 2SD414</p> 	<p>Q1001, 1002: 2SC1364 (2SC634A)</p> 	<p>D801-805 } : 10E2 806-809 } 814, 821 } D812, 813 } : 1S1555 815, 817 } 828-833 }</p> 
<p>Q802, 808: 2SA1027R (2SA1015)</p> 	<p>Q1003, 1005: 2SC1475 (2SD471)</p> 	<p>D810, 811: HZ11B2L D816, 818: HZ12A3L (HZ12A2L) D819: HZ12B2L (HZ12B1L) D1001: HZ6B2L (HZ6B1L)</p> 
<p>Q803, 805, 822: 2SB548</p> 	<p>Q1004, 1006: 2SA684 (2SB564)</p> 	<p>D824: SEL1331G</p> 
<p>Q804, 806 } : 2SC1364 (2SC1815) 809, 817-819 } 821, 823 }</p> 	<p>IC801: μPD547C-042</p>  <p>(Top view)</p>	<p>D825: SEL1112R</p> 
<p>Q810: 2SA684 (2SA773)</p> 	<p>IC802, 803: MSM4069</p>  <p>(Top view)</p>	<p>D826: SEL1741Y</p> 
<p>Q811, 812 : 2SC1475</p> 	<p>IC805: μPC339C</p>  <p>(Top view)</p>	<p>D827: SR110</p> 
<p>Q820: PH103</p> 	<p>IC806: μPC4558C IC1002: μPC4558C (μPC4558)</p>  <p>(Top view)</p>	<p>D827: SR110</p> 
	<p>IC1001: CX069</p> 	

4-1. SCHEMATIC DIAGRAM — System Control Section —

Refer to page 19 for replacement semiconductors and page 25 for voltages and waveforms at the terminals of IC801.

Note:

- All capacitors are in μF unless otherwise noted. p : μF 50WV or less are not indicated except for electrolytics.
- All resistors are in ohms, 1/4W unless otherwise noted. k Ω : 1000 Ω , M Ω : 1000k Ω
- : fusible resistor
- : nonflammable resistor.
- 1% indicates component tolerance.
- : B+ bus.
- : B- bus.
- : panel designation.
- : adjustment for repair.
- Voltages are dc with respect to ground unless otherwise noted.
- Readings are taken with a VOM (20 k Ω /V).
- no mark: STOP
- : FORWARD
- : FAST FORWARD
- : REWIND
- : RECORD
- : REC MUTE
- : PAUSE
- : STOP
- Voltage variations may be noted due to normal production tolerances.
- Switch

Ref. No.	Switch	Position
S801	POWER	OFF
S802	REWIND	OFF
S803	STOP	OFF
S804	FORWARD	OFF
S805	FAST FORWARD	OFF
S806	RECORD	OFF
S807	PAUSE	OFF
S808	REC MUTE	OFF
S812	ACCIDENTAL-ERASURE PREVENTION	ON
S813	CASSETTE	OFF

Note: The components identified by shading and mark are critical for safety. Replace only with part number specified.

Note: Les composants identifiés par un trame et une marque sont critiques pour la sécurité. Ne les remplacer que par une pièce portant le numéro spécifié.

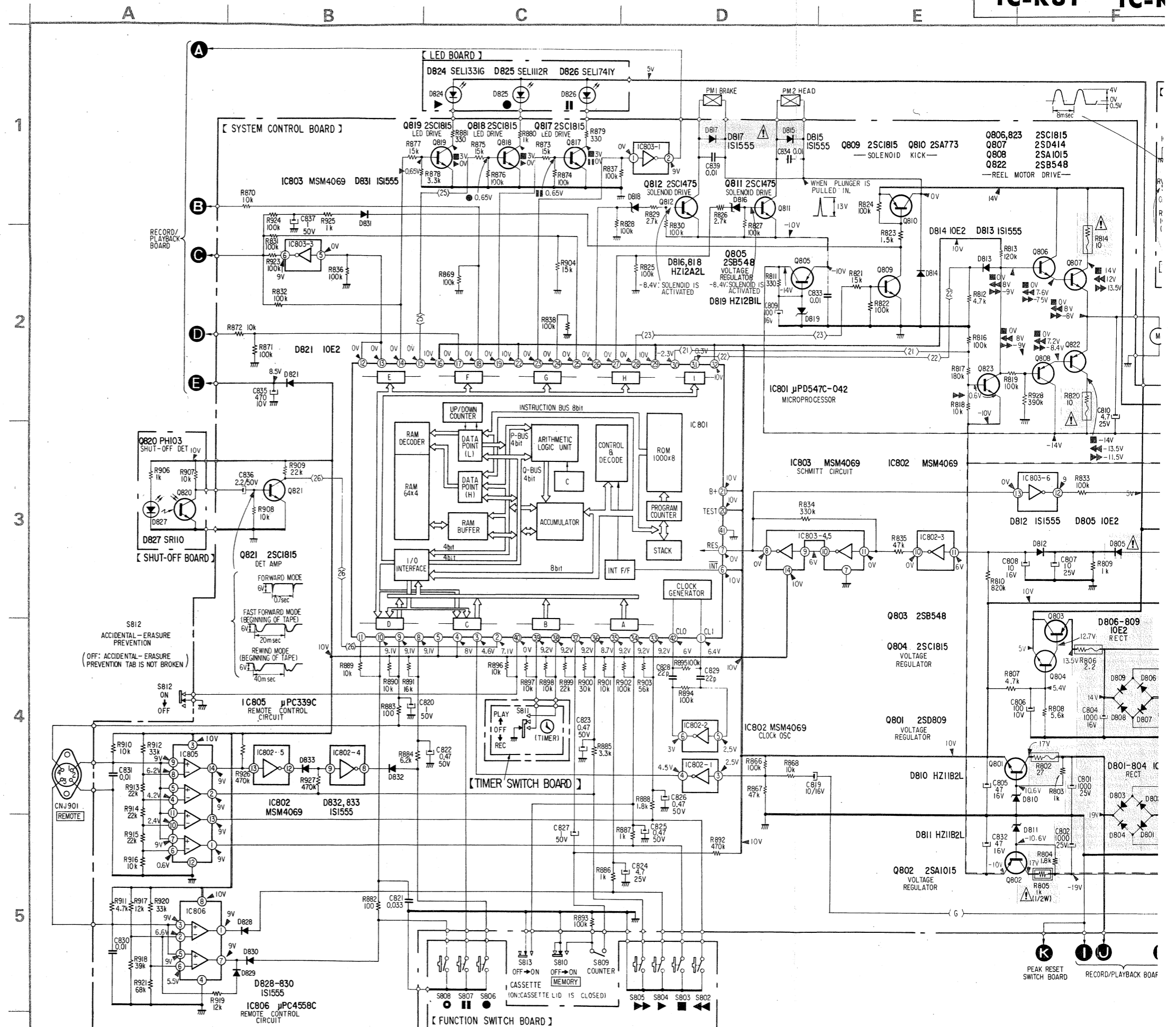

TC-K81 TC-K81

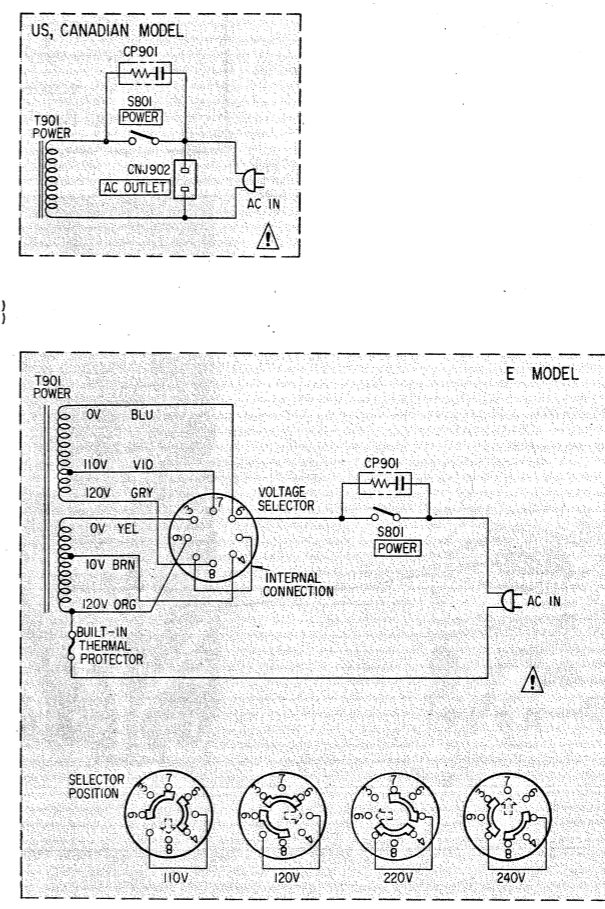
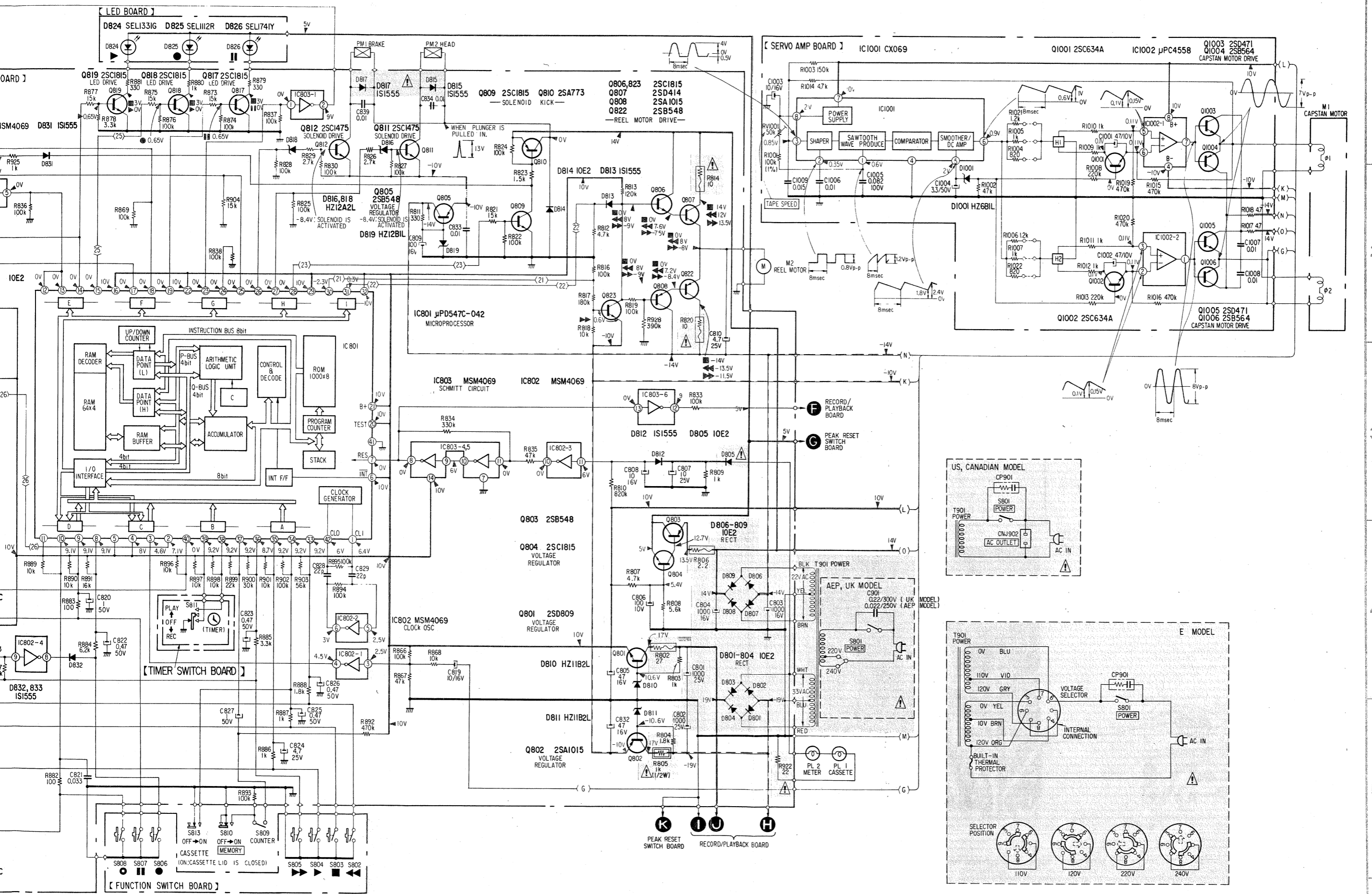

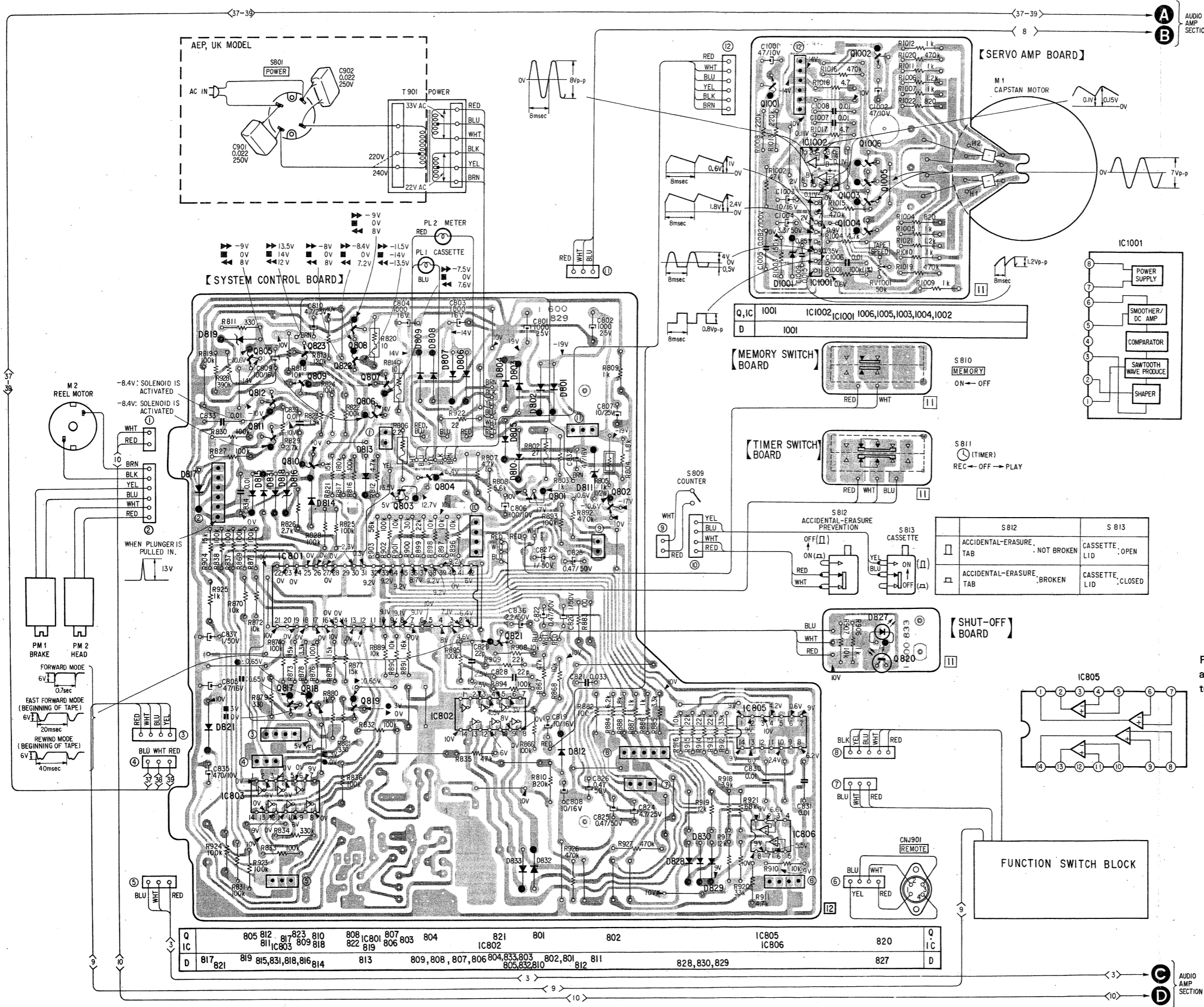

Refer to page 19 for replacement semiconductors and page 25 for voltages and waveforms at the terminal of IC801.

Note:
 • Color code of sleeving over the end of the jacket.

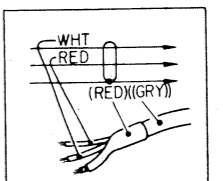

- : B+ pattern.
- : B - pattern
- no mark: STOP
- ▶ : FORWARD
- ▶▶ : FAST FORWARD
- ◀ : REWIND
- ◐ : RECORD
- ◑ : REC MUTE
- ◒ : PAUSE
- ◓ : STOP

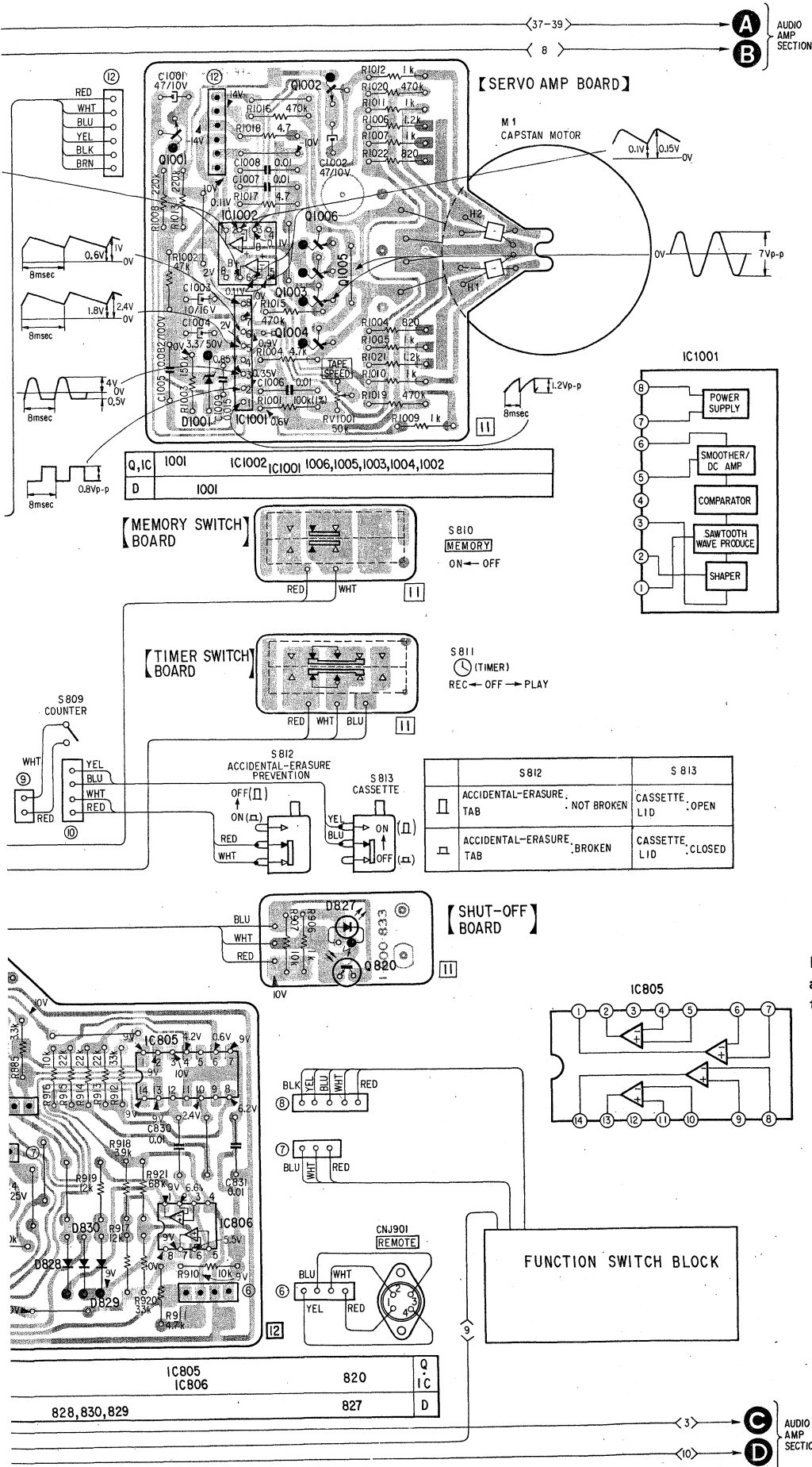

Refer to page 19 for replacement semiconductors and page 25 for voltages and waveforms at the terminal of IC801.

Note:

- Color code of sleeving over the end of the jacket.

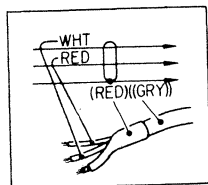

- WHT : B+ pattern.
- RED : B - pattern
- no mark : STOP
- ▶ : FORWARD
- ▶▶ : FAST FORWARD
- ◀ : REWIND
- ◀◀ : RECORD
- : REC MUTE
- : PAUSE
- : STOP

Voltages and Waveforms at the Terminals of IC801.

Terminal No.	Waveform or Voltage	Terminal No.	Waveform or Voltage	Terminal No.	Waveform or Voltage
①	10V p.p. 4 μsec	⑭	Forward Mode 10V 0V	⑲	10 Vdc
②	● Forward Mode 10V p.p. 0.7 sec	⑮	Record Mode 10V 0V	⑳	Fast Forward Mode 10V -2.2V 0.3 sec. Fast Forward button is pushed.
	● Fast Forward Mode 10V p.p. 20 msec		⑯		10 Vdc
③	8V p.p. 8 msec	⑰	Forward Mode 10V 0V 0.5 sec Forward button is pushed.	㉒	10 Vdc
			⑱		Record/Forward Mode 10V 0V
④ to ⑥	10 Vdc	⑳ to ㉒	Pause Mode 10V 0V	㉔	10V 0V Stop button is pushed or the cassette lid is open.
⑦	2.5 sec 10V p.p. 0.5 sec		㉓		Record/Forward button is pushed. Record Muting or Pause button is pushed.
		⑧		Record button is pushed.	㉖
⑨	Pause button is pushed.	㉗	Forward or Record Mode 10V 0V 0.6 sec	㉘	
⑩	Record button is pushed.		㉘		Fast Forward or Rewind Mode or Record/Forward/Pause Mode 10V 0V
⑪	10 Vdc	㉙		Forward Mode 10V 0V	㉚
			⑫ ⑬	Fast Forward or Rewind Mode 10V 0V	
⑫ ⑬	Fast Forward or Rewind Mode 10V 0V	㉛			0.35 sec. 10V 0V Forward or Fast Forward or Rewind button is pushed.

- Color code of sleeving over the end of the jacket.

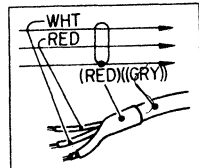

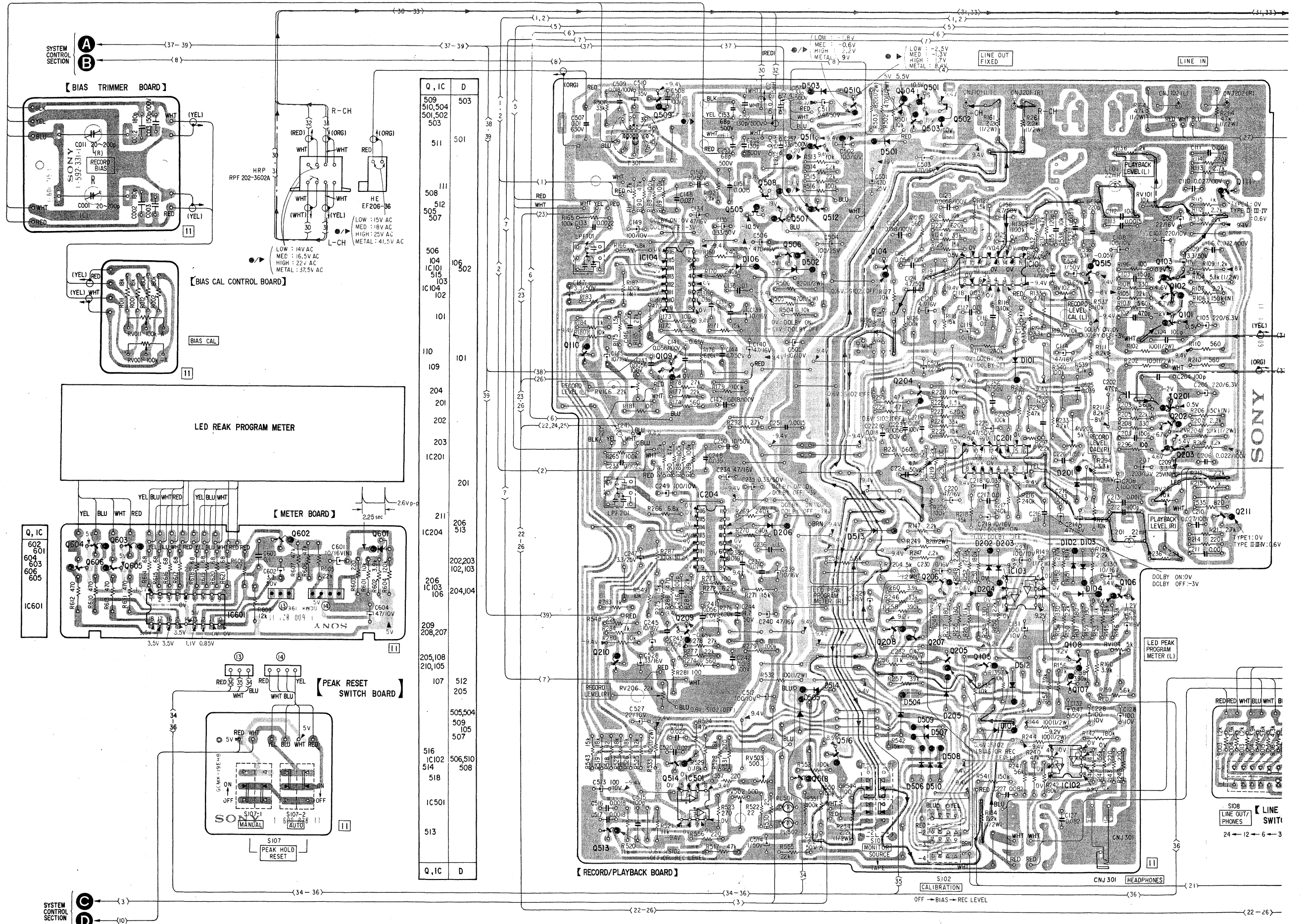

- B + pattern
- B - pattern
- Signal path
 - L-CH
 - R-CH
 - Common
- no mark: STOP
- ▶ : FORWARD
- ▶▶ : FAST FORWARD
- ◀ : REWIND
- ◀◀ : RECORD
- : PAUSE
- : STOP

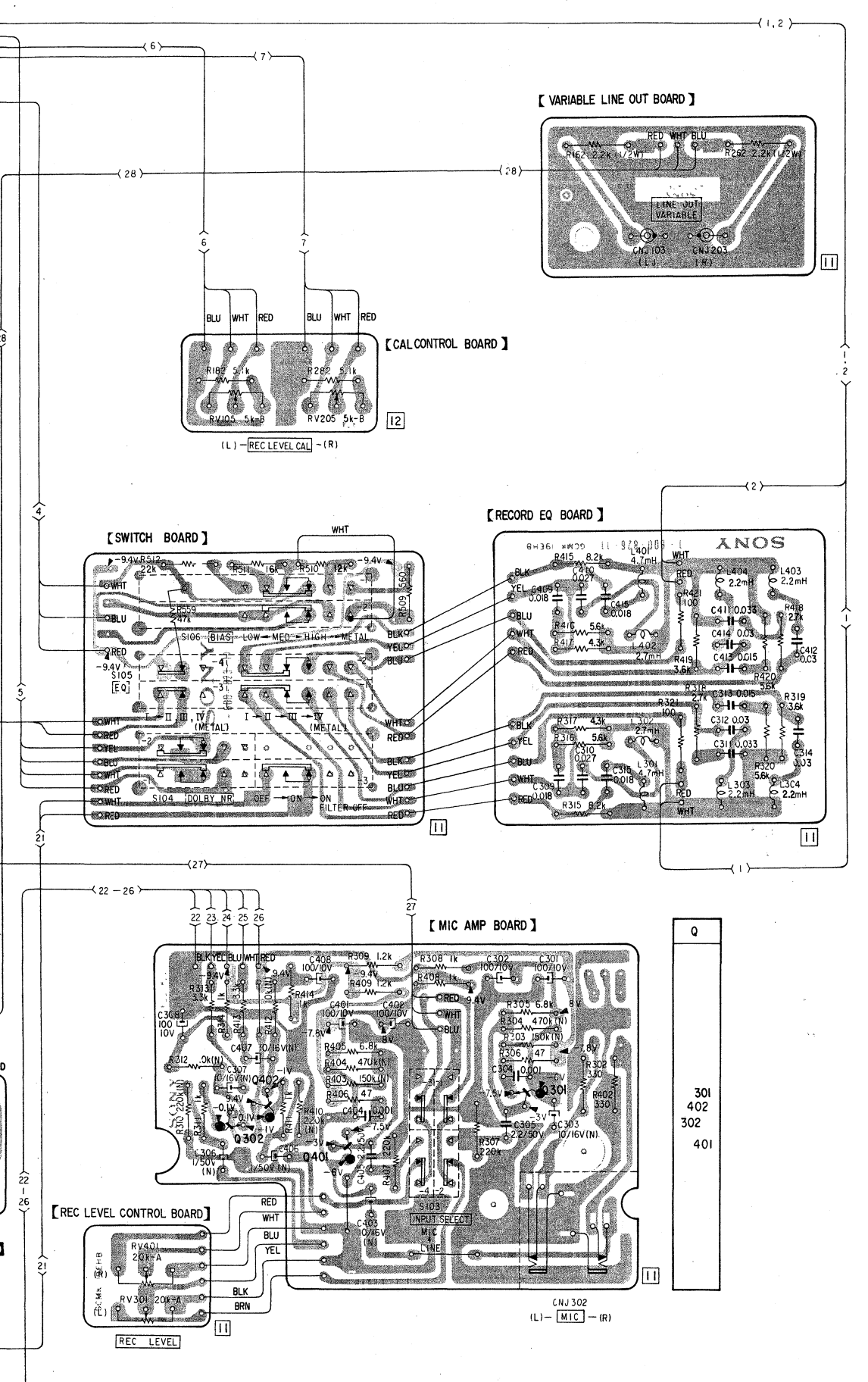
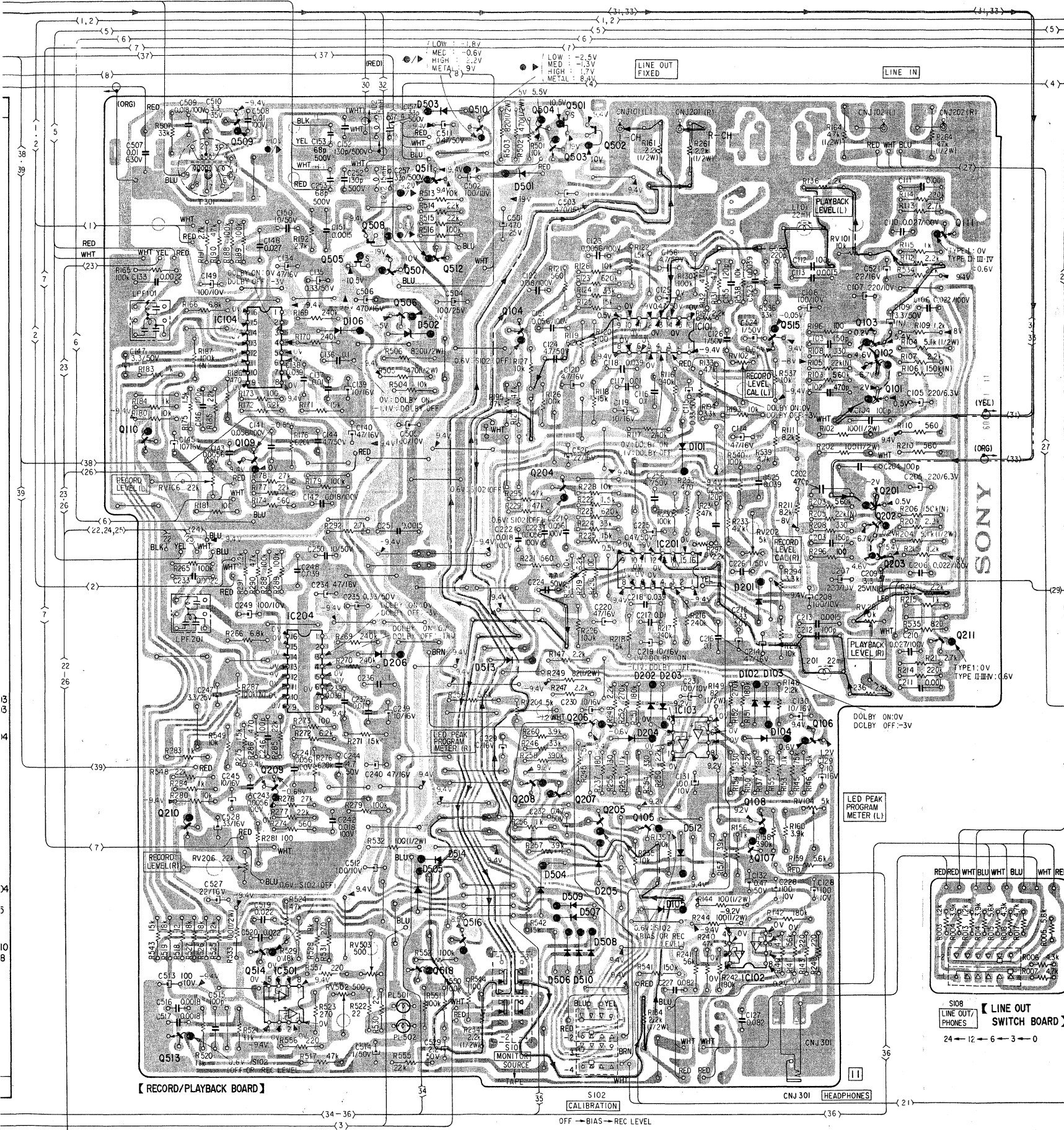

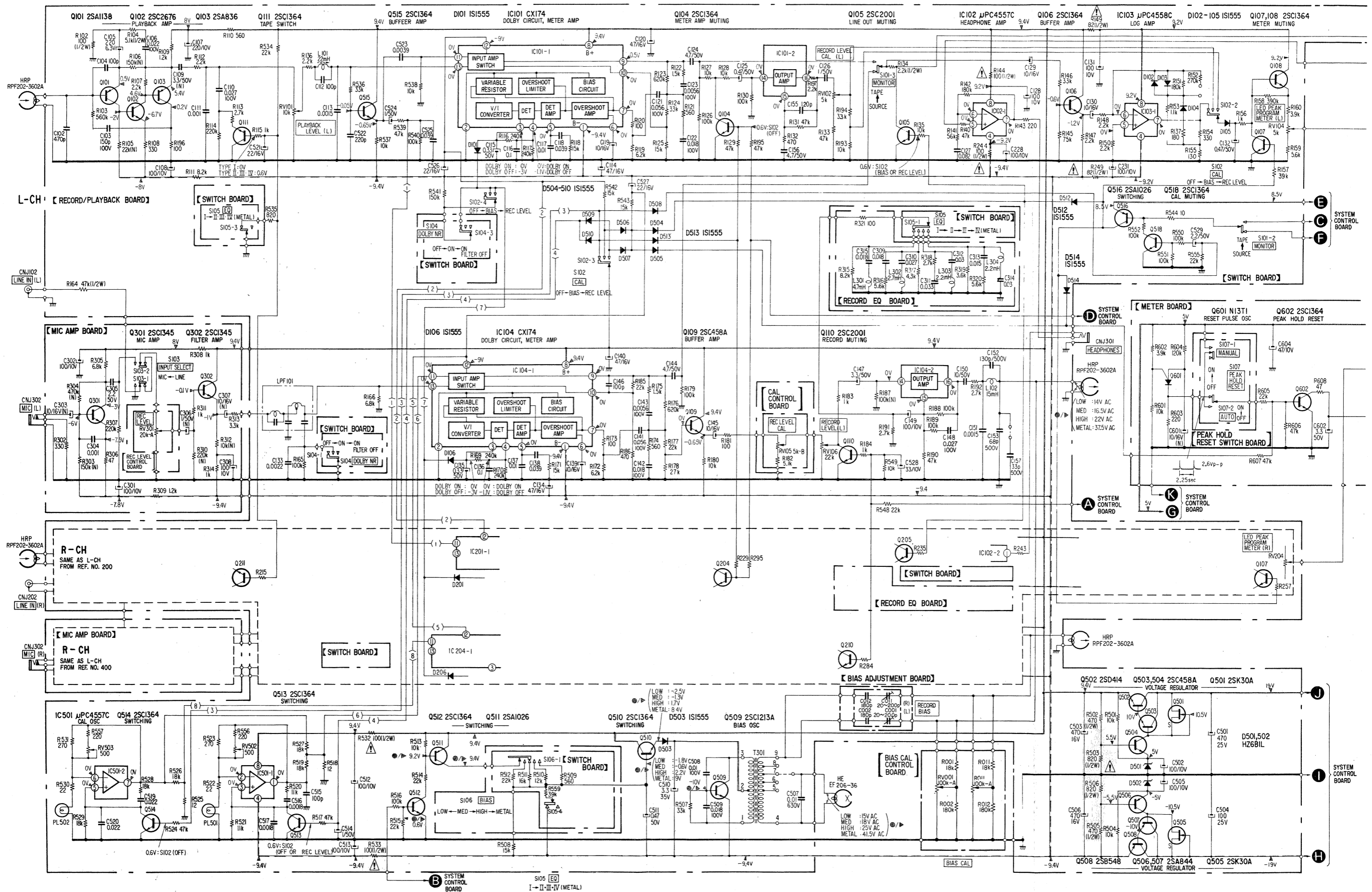

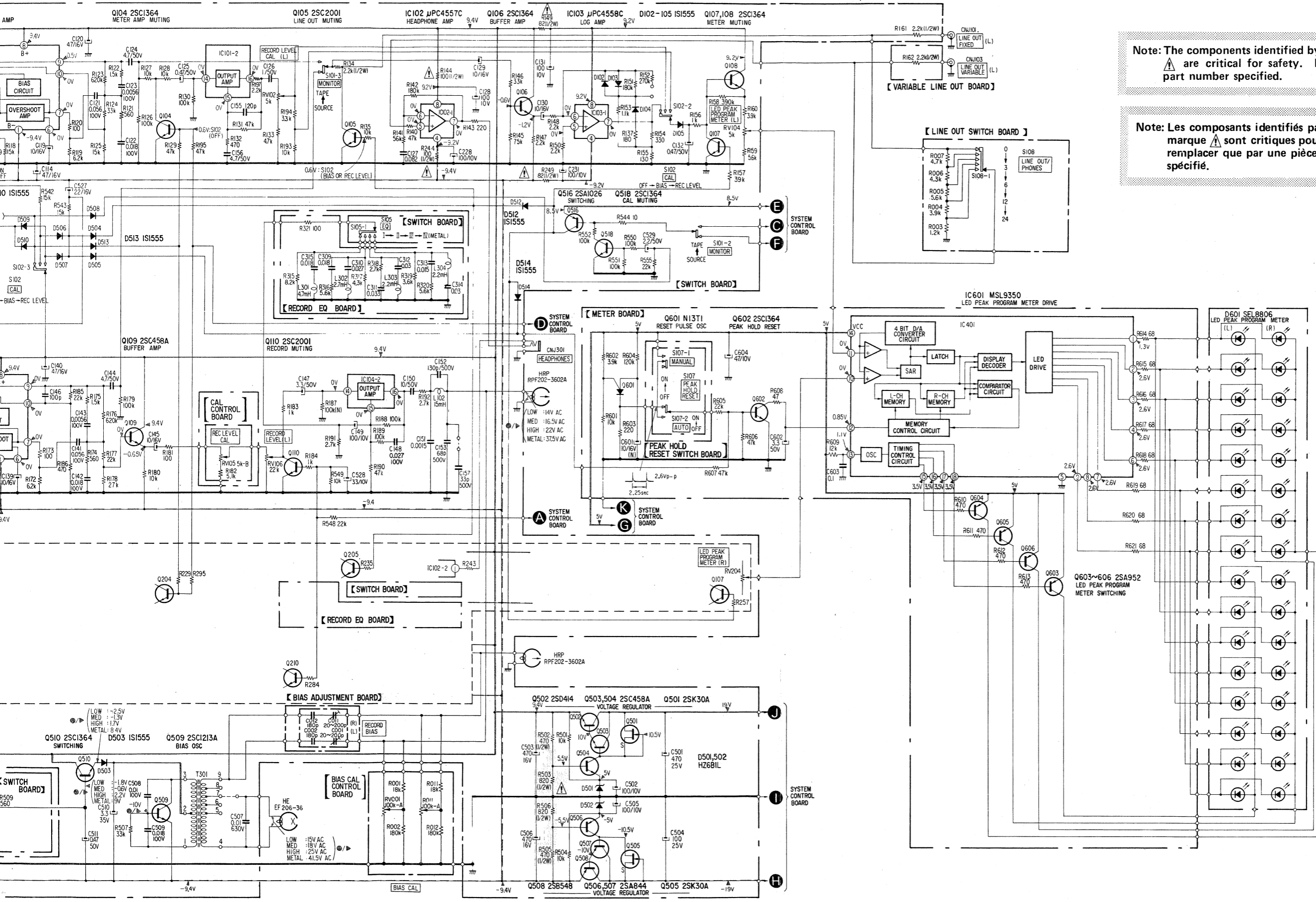



Note: The components identified by shading and mark  are critical for safety. Replace only with part number specified.

Note: Les composants identifiés par une trame et une marque  sont critiques pour la sécurité. Ne les remplacer que par une pièce portant le numéro spécifié.

1
2
3
4
5

— Audio Amp Section —

Note:

- Components for right channel have same values as for left channel. Reference numbers are coded from 200 and 400.
- All capacitors are in μF unless otherwise noted. $\text{pF} = \mu\mu\text{F}$ 50WV or less are not indicated except for electrolytics.
- All resistors are in ohms, $\frac{1}{4}\text{W}$ unless otherwise noted. $\text{k}\Omega : 1000 \Omega$, $\text{M}\Omega = 1000 \text{k}\Omega$
- : fusible resistor.
- (N) : low-noise.
- : B+ bus.
- : B- bus.
- : panel designation.
- : adjustment for repair.
- Voltages are dc with respect to ground unless otherwise noted.
- Readings are taken under no signal conditions with a VOM (20 $\text{k}\Omega/\text{V}$).
- no mark: STOP
- : FORWARD
- : FAST FORWARD
- : REWIND
- : RECORD
- : REC MUTE
- : PAUSE
- : STOP
- AC voltage readings in the bias oscillator circuit are taken with a VTVM.
- Voltage variations may be noted due to normal production tolerances.
- Switch

Ref. No.	Switch	Position
S101-1 to 101-4	MONITOR	TAPE
S102-1 to 101-4	CALIBRATION	OFF
S103-1 to 103-4	INPUT SELECT	LINE
S104-1 to 104-3	DOLBY NR	OFF
S105-1 to 105-4	EQ	I
S106-1, 2	BIAS	MED
S107-1	MANUAL	OFF
S107-2	AUTO	ON

IC101, 104, 201, 204

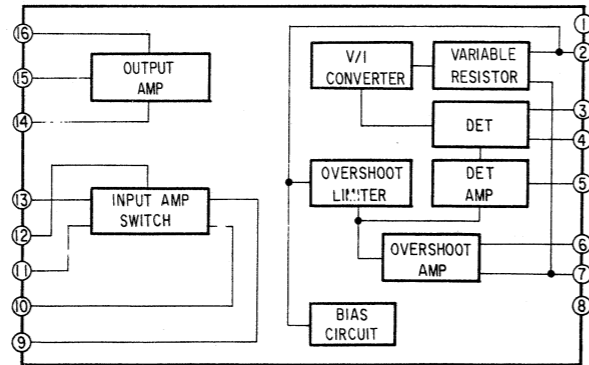

IC601

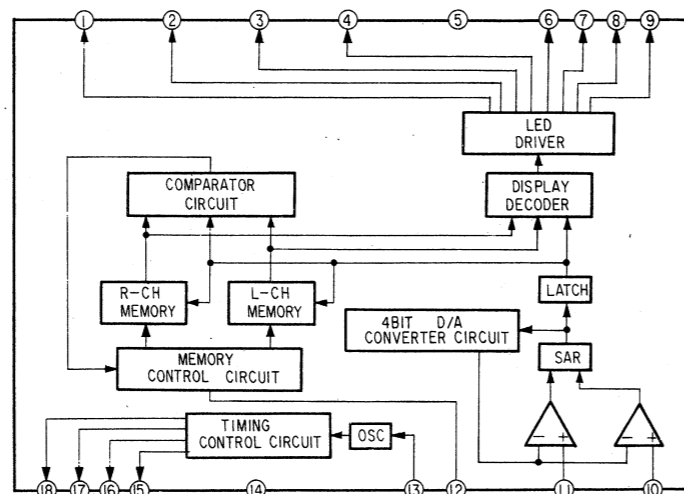

— Audio Amp Section —

• Replacement Semiconductors

For replacement, use semiconductors except in ().

Q101, 201 : 2SA1138

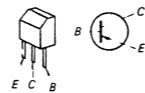

Q501, 505 : 2SK30A

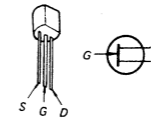

IC101, 201 } : CX174
IC104, 204 }

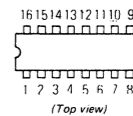

Q102, 202 : 2SC2676

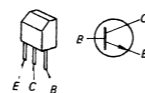

Q502 : 2SD414

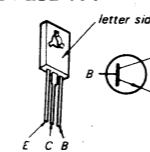

IC102, 202 } : $\mu\text{PC4557C}$
IC501
IC103, 203 : $\mu\text{PC4558C}$



Q103, 203 : 2SA872-E (2SA836)

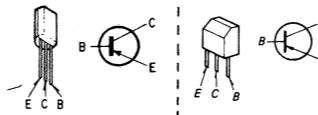

Q506, 507 : 2SA1027R (2SA844)
Q511, 516 : 2SA1027R (2SA1026)

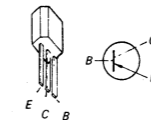

IC601 : MSL9350

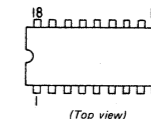

Q104, 204 } : 2SC1364
Q106-108
Q206-208
Q111, 211
510, 512-515
518, 602

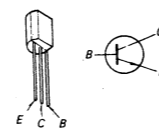

Q508 : 2SB548

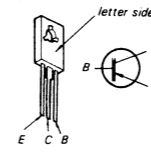

D101-106 } : 1S1555
201-206
503-510
512-514

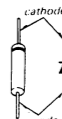

Q105, 205 } : 2SC2001
Q110, 210
Q301, 401
Q302, 402

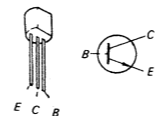

Q509 : 2SC1475 (2SC1213A)

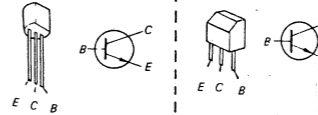

D501, 502 : HZ6B2L (HZ6B1L)

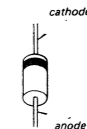

Q601 : N13T1

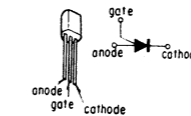

Q109, 209 } : 2SC1362 (2SC458A)
Q503, 504

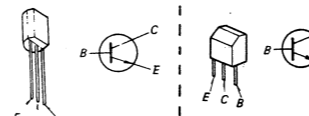

Q603-606 : 2SA952

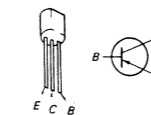

E
D
C
B
A

SECTION 5
EXPLODED VIEWS

— Audio Amp Section —

• Replacement Semiconductors

For replacement, use semiconductors except in ().

<p>Q101, 201 : 2SA1138</p>	<p>Q501, 505 : 2SK30A</p>	<p>IC101, 201 IC104, 204 } : CX174</p>
<p>Q102, 202 : 2SC2676</p>	<p>Q502 : 2SD414</p>	<p>IC102, 202 IC501 } : μPC4557C</p> <p>IC103, 203 : μPC4558C</p>
<p>Q103, 203 : 2SA872-E (2SA836)</p>	<p>Q506, 507 : 2SA1027R (2SA844) Q511, 516 : 2SA1027R (2SA1026)</p>	<p>IC601 : MSL9350</p>
<p>Q104, 204 Q106-108 Q206-208 Q111, 211 510, 512-515 518, 602 } : 2SC1364</p>	<p>Q508 : 2SB548</p>	<p>D101-106 201-206 503-510 512-514 } : 1S1555</p>
<p>Q105, 205 Q110, 210 Q301, 401 Q302, 402 } : 2SC2001</p>	<p>Q509 : 2SC1475 (2SC1213A)</p>	<p>D501, 502 : HZ6B2L (HZ6B1L)</p>
<p>Q109, 209 Q503, 504 } : 2SC1362 (2SC458A)</p>	<p>Q601 : N13TI</p>	
	<p>Q603-606 : 2SA952</p>	

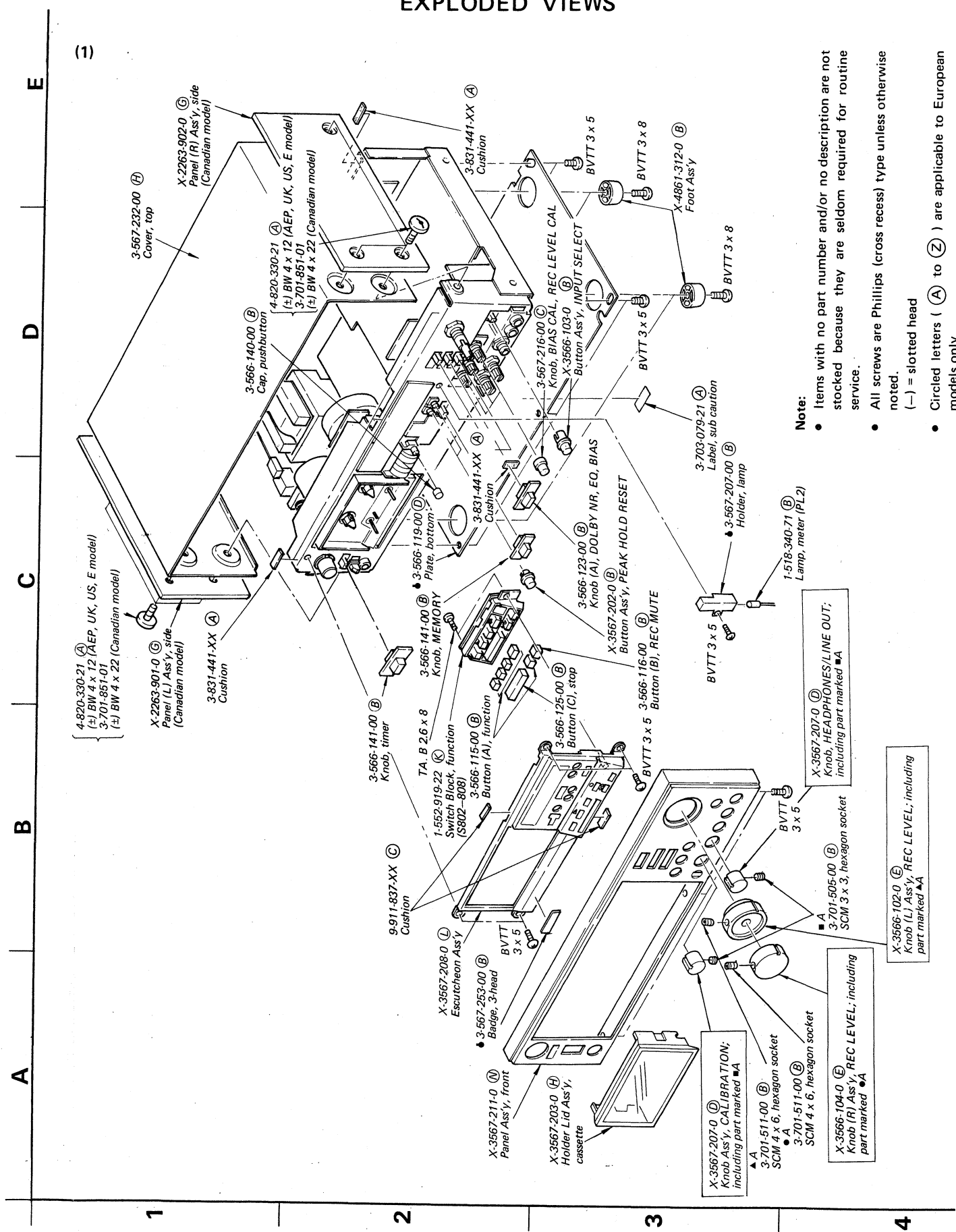

Note:

- Items with no part number and/or no description are not stocked because they are seldom required for routine service.
- All screws are Phillips (cross recess) type unless otherwise noted.
- (-) = slotted head
- Circled letters (A) to (Z) are applicable to European models only.

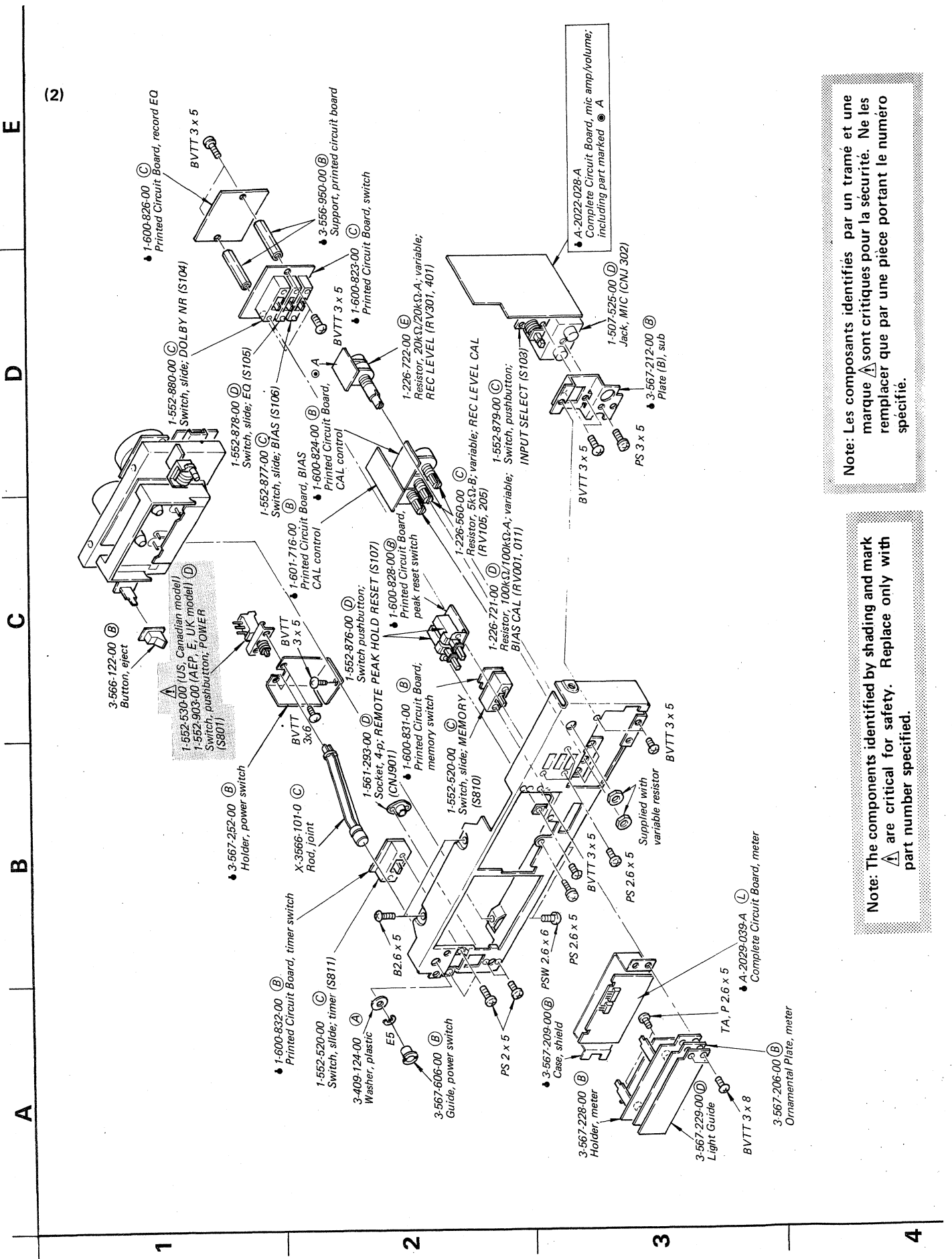

Note: Les composants identifiés par un trame et une marque Δ sont critiques pour la sécurité. Ne les remplacer que par une pièce portant le numéro spécifié.

Note: The components identified by shading and mark Δ are critical for safety. Replace only with part number specified.

A B C D E

- Items with no part number and/or no description are not stocked because they are seldom required for routine service.
- All screws are Phillips (cross recess) type unless otherwise noted.
- Circled letters (A) to (Z) are applicable to European models only.

1

2

3

4

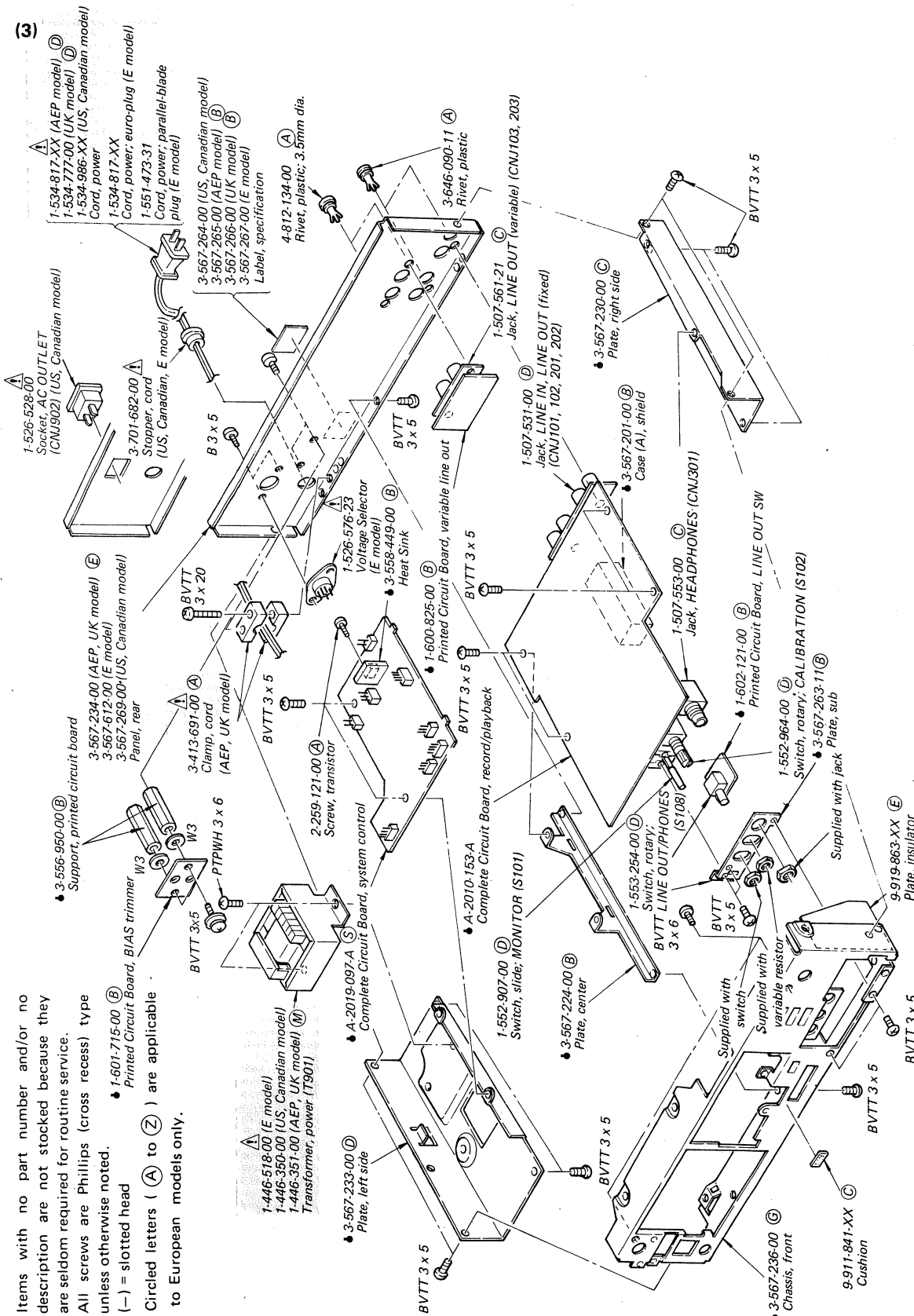

Note: Les composants identifiés par un trame et une marque **A** sont critiques pour la sécurité. Ne les remplacer que par une pièce portant le numéro spécifié.

Note: The components identified by shading and mark **A** are critical for safety. Replace only with part number specified.

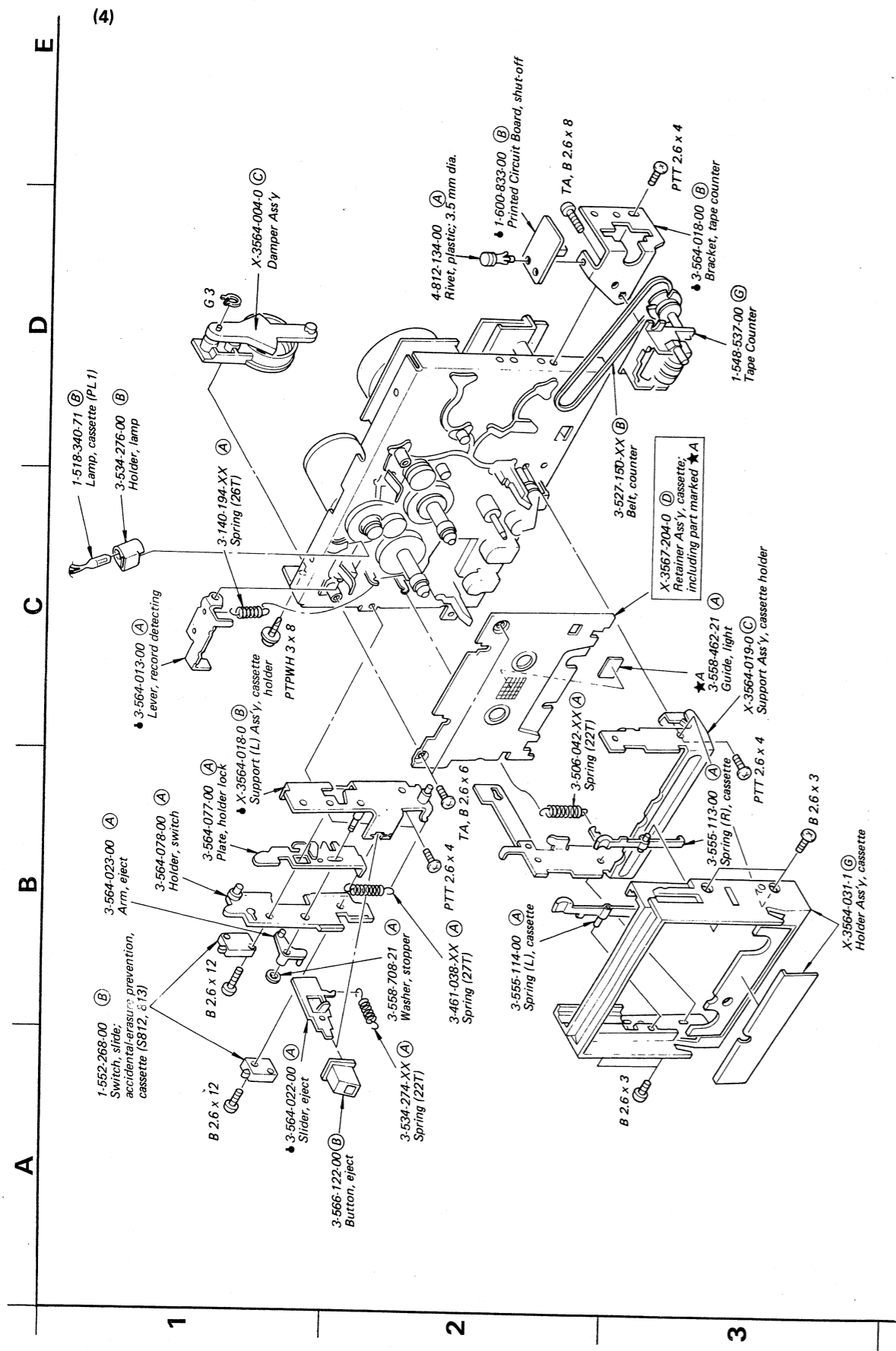

- Note:**
- Items with no part number and/or no description are not stocked because they are seldom required for routine service.
 - All screws are Phillips (cross recess) type unless otherwise noted.
 - (-) = slotted head
 - (□□□) shows the number of coils in spring.
 - Circled letters (A) to (Z) are applicable to European models only.

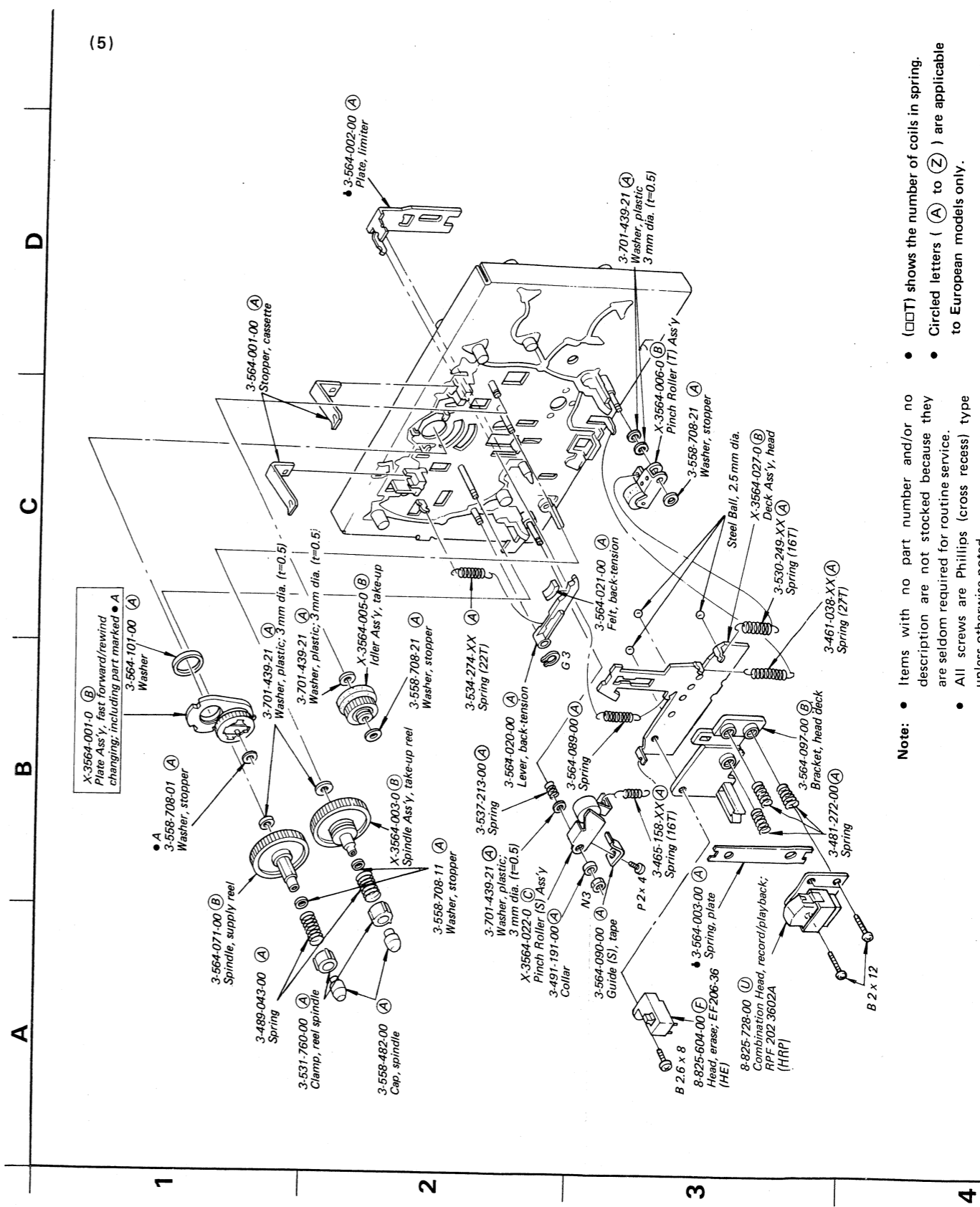

- Note:**
- Items with no part number and/or no description are not stocked because they are seldom required for routine service.
 - All screws are Phillips (cross recess) type unless otherwise noted.
 - (-) = slotted head
 - (□□□) shows the number of coils in spring.
 - Circled letters (A) to (Z) are applicable to European models only.

SECTION 6
ELECTRICAL PARTS LIST

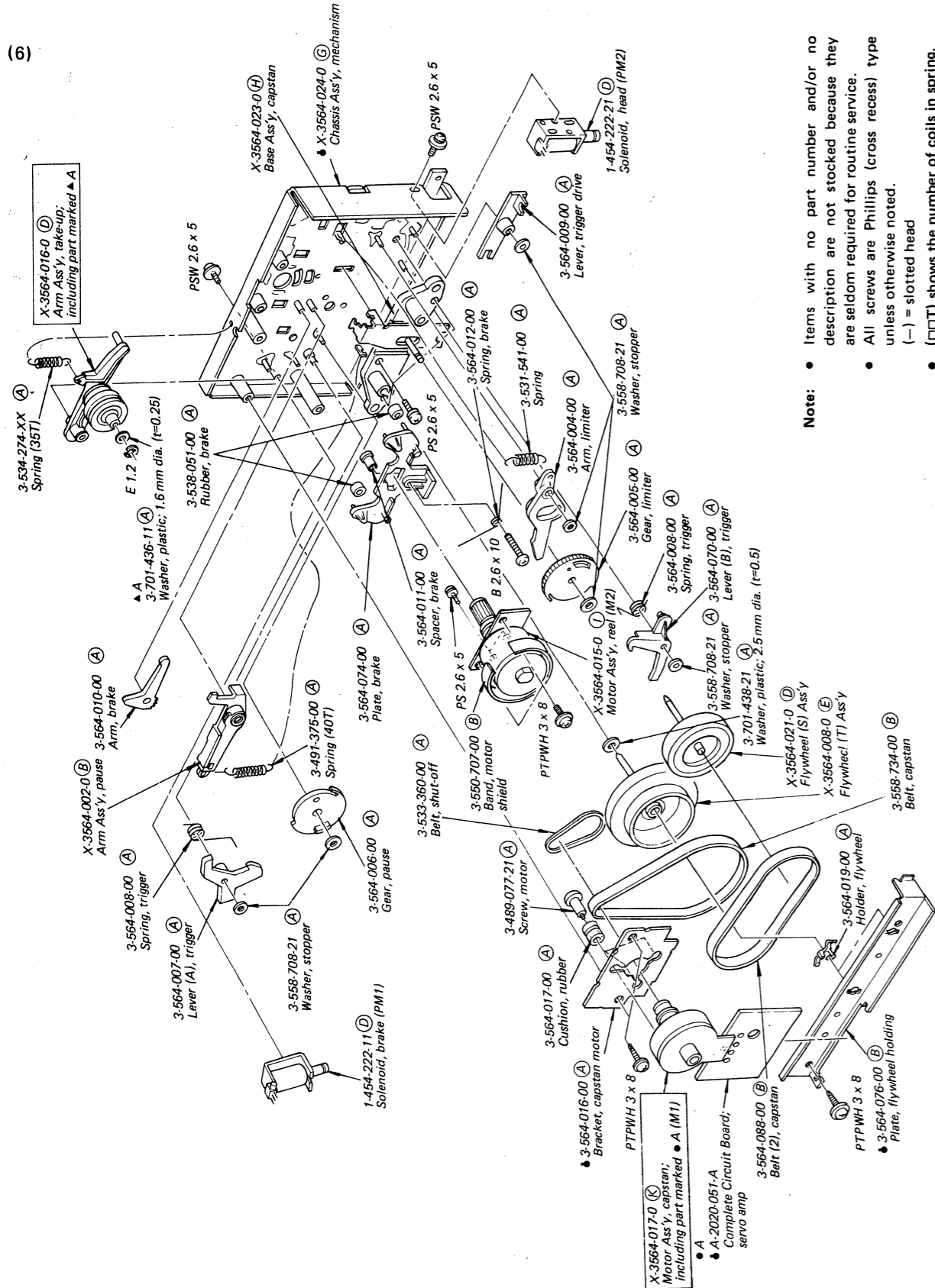

Note:

- Items with no part number and/or no description are not stocked because they are seldom required for routine service.
- All screws are Phillips (cross recess) type unless otherwise noted.
- (□□□) shows the number of coils in spring.
- Circled letters (A) to (Z) are applicable to European models only.

Ref. No.	Part No.	Description
SEMICONDUCTORS		
Transistors		
Q101, 201	8-729-113-82	(K) 2SA1138
Q102, 202	8-729-167-62	(B) 2SC2676
Q103, 203	8-729-387-28	(B) 2SA872-E
Q104, 204	8-729-663-47	(C) 2SC1364
Q105, 205	8-729-100-13	(B) 2SC2001
Q106-108, Q206-208	8-729-663-47	(C) 2SC1364
Q109, 209	8-729-665-47	(B) 2SC1362
Q110, 210	8-729-100-13	(B) 2SC2001
Q111, 211	8-729-663-47	(C) 2SC1364
Q301, 302, Q401, 402	8-729-334-58	(B) 2SC1345
Q501	8-729-203-04	(B) 2SK30A
Q502	8-729-141-43	(B) 2SD414
Q503, 504	8-729-665-47	(B) 2SC1362
Q505	8-729-203-04	(B) 2SK30A
Q506, 507	8-729-612-77	(B) 2SA1027R
Q508	8-729-154-83	(B) 2SB548
Q509	8-760-413-10	(B) 2SC1475
Q510	8-729-663-47	(B) 2SC1364
Q511	8-729-612-77	(B) 2SA1027R
Q512-515	8-729-663-47	(B) 2SC1364
Q516	8-729-612-77	(B) 2SA1027R
Q518	8-729-663-47	(B) 2SC1364
Q601	8-729-101-31	(B) N13T1
Q602	8-729-663-47	(B) 2SC1364
Q603-606	8-729-195-23	(B) 2SA952
Q801	8-729-180-93	(B) 2SD809
Q802	8-729-612-77	(B) 2SA1027R
Q803	8-729-154-83	(B) 2SB548
Q804	8-729-663-47	(C) 2SC1364
Q805	8-729-154-83	(B) 2SB548
Q806	8-729-663-47	(C) 2SC1364
Q807	8-729-141-43	(B) 2SD414
Q808	8-729-612-77	(B) 2SA1027R
Q809	8-729-663-47	(C) 2SC1364
Q810	8-729-468-43	(C) 2SA684

Note: Circled letters (A) to (Z) are applicable to European models only.

Note: The components identified by shading and mark **A** are critical for safety. Replace only with part number specified.

Ref. No.	Part No.	Description
Q811, 812	8-760-413-10	(B) 2SC1475
Q817-819	8-729-663-47	(C) 2SC1364
Q820	8-729-101-03	(B) PH103
Q821	8-729-663-47	(C) 2SC1364
Q822	8-729-154-83	(B) 2SB548
Q823	8-729-663-47	(C) 2SC1364
Q1001, 1002	8-729-663-47	(C) 2SC1364
Q1003	8-760-335-10	(B) 2SC1474
Q1004	8-729-468-43	(C) 2SA684
Q1005	8-760-335-10	(C) 2SC1474
Q1006	8-729-468-43	(C) 2SA684
ICs		
IC101, 201	8-759-101-74	(F) CX174
IC102, 202	8-759-145-57	(D) μ PC4557C
IC103, 203	8-759-145-58	(D) μ PC4558C
IC104, 204	8-759-101-74	(F) CX174
IC501	8-759-145-57	(D) μ PC4557C
IC601	8-759-993-50	(K) MSL9350
IC801	8-759-147-42	(L) μ PD547C-042
IC802, 803	8-759-904-69	(C) MSM4069
IC805	8-759-133-90	(F) μ PC339C
IC806	8-759-145-58	(D) μ PC4558C
IC1001	8-750-690-00	(D) CX069
IC1002	8-759-145-58	(D) μ PC4558C
Diodes		
D101-106, D201-206	8-719-815-55	(B) 1S1555
D501, 502	8-719-910-65	(B) HZ6B2L
D503-510, D512-514	8-719-815-55	(B) 1S1555
D601	1-800-822-11	(K) SEL8806
D801-809	8-719-200-02	(B) 10E2
D810, 811	8-719-910-15	(B) HZ11B2L
D812, 813	8-719-815-55	(B) 1S1555
D814	8-719-200-02	(B) 10E2
D815	8-719-815-55	(B) 1S1555
D816	8-719-910-23	(B) HZ12A3L

Note: Les composants identifiés par une trame et une marque **A** sont critiques pour la sécurité. Ne les remplacer que par une pièce portant le numéro spécifié.

Ref. No.	Part No.	Description
D817	▲8-719-815-55	(B) 1S1555
D818	8-719-910-23	(B) HZ12A3L
D819	8-719-910-25	(B) HZ12B2L
D821	8-719-200-02	(B) 10E2
D828-831	8-719-815-55	(B) 1S1555
D824	8-719-313-31	(B) SEL1331G
D825	8-719-311-12	(B) SEL1112R
D826	8-719-317-41	(B) SEL1741Y
D827	8-719-101-11	(B) SR110
D832, 833	8-719-815-55	(B) 1S1555
D1001	8-719-910-65	(B) HZ6B2L

CAPACITORS

All capacitors are in μ F and ceramic unless otherwise noted. 50WV or less are not indicated except for electrolytics and tantalum. Common capacitors are omitted. Refer to the lists on page 44 and 45 for their part numbers.

C001, 011	1-141-010-XX	(B) Trimmer
C102, 202	1-161-319-00	(A) 470p
C103, 203	1-107-304-00	(B) 150p 100V silvered mica
C106, 206	1-130-305-00	(B) 0.022 100V polyethylene
C109, 209	1-123-231-00	(B) 3.3 50V elect (nonpolarized)
C110, 210	1-130-307-00	(B) 0.027 100V polyethylene
C111, 211	1-161-323-00	(A) 0.001
C115, 215	1-123-286-00	(B) 0.33 50V elect
C121, 221	1-130-341-00	(B) 0.056 100V polyethylene
C122, 222	1-130-340-00	(B) 0.018 100V polyethylene
C123, 223	1-130-339-00	(B) 0.0056 100V polyethylene
C124, 224	1-123-232-00	(B) 4.7 50V elect (nonpolarized)
C126, 226	1-123-228-00	(B) 1 50V elect (nonpolarized)
C135, 235	1-123-286-00	(B) 0.33 50V elect
C141, 241	1-130-341-00	(B) 0.056 100V polyethylene
C142, 242	1-130-340-00	(B) 0.018 100V polyethylene
C143, 243	1-130-339-00	(B) 0.0056 100V polyethylene
C144, 244	1-123-232-00	(B) 4.7 50V elect (nonpolarized)
C147, 247	1-123-231-00	(B) 3.3 50V elect (nonpolarized)
C148, 248	1-130-307-00	(B) 0.027 100V polyethylene
C150, 250	1-123-234-00	(B) 10 50V elect (nonpolarized)
C156, 256	1-123-232-00	(B) 4.7 50V elect (nonpolarized)
C303, 403	1-121-651-00	(A) 10 16V elect

Note: Circled letters (A to Z) are applicable to European models only.

Note: The components identified by shading and mark ▲ are critical for safety. Replace only with part number specified.

Ref. No.	Part No.	Description
C304, 404	1-161-323-00	(A) 0.001
C305, 405	1-123-230-00	(B) 2.2 50V elect (nonpolarized)
C306, 406	1-123-228-00	(B) 1 50V elect (nonpolarized)
C507	1-130-338-00	(B) 0.01 630V polyethylene
C508	1-130-297-00	(B) 0.01 100V polyethylene
C509	1-130-303-00	(B) 0.018 100V polyethylene
C522	1-161-315-00	(A) 220p
C530, 531	1-131-450-00	(C) 1 35V tantalum
C601	1-121-651-00	(A) 10 16V elect
C801, 802	▲1-123-337-00	(B) 1000 25V elect
C803, 804	▲1-123-324-00	(B) 1000 16V elect
C901	▲1-130-232-00	(B) 0.22 300V film (UK model)
	▲1-130-456-00	(C) 0.022 250V film (AEP model)
C1001, 1002	1-123-306-00	(B) 47 10V elect
C1003	1-123-316-00	(B) 10 16V elect
C1004	1-123-354-00	(B) 3.3 50V elect
C1005	1-130-134-00	(B) 0.082 100V polyethylene
	1-130-232-00	(B) 0.22 300V film (UK model)
	1-130-456-00	(C) 0.022 250V film (AEP model)

RESISTORS

All resistors are in ohms. Common $\frac{1}{4}$ W carbon resistors are omitted. Refer to the list on page 46 for their part numbers. k Ω : 1000 Ω , M Ω : 1000 k Ω

R102, 202	1-214-840-00	(B) 100 $\frac{1}{2}$ W metal oxide
R104, 204	1-214-881-00	(B) 5.1k $\frac{1}{2}$ W metal oxide
R106, 206	1-214-781-00	(A) 150k metal oxide
R112, 212	1-214-737-00	(A) 2.2k metal oxide
R113, 213	1-214-739-00	(A) 2.7k metal oxide
R124, 224	1-214-765-00	(A) 33k metal oxide
R125, 225	1-214-757-00	(A) 15k metal oxide
R134, 234	1-214-872-00	(A) 2.2k $\frac{1}{2}$ W metal oxide
R136, 236	1-214-737-00	(A) 2.2k metal oxide
R144, 244	▲1-244-849-00	(A) 100 $\frac{1}{2}$ W carbon
R149, 249	▲1-244-847-00	(A) 82 $\frac{1}{2}$ W carbon
R161, 261	1-214-872-00	(B) 2.2k $\frac{1}{2}$ W metal oxide
R162, 262	1-214-872-00	(B) 2.2k $\frac{1}{2}$ W metal oxide
R164, 264	1-214-905-00	(B) 47k $\frac{1}{2}$ W metal oxide
R177, 277	1-214-761-00	(A) 22k metal oxide
R178, 278	1-214-763-00	(A) 27k metal oxide
R180, 280	1-214-753-00	(A) 10k metal oxide
R188, 288		
R189, 289	1-214-777-00	(A) 100k metal oxide

Note: Les composants identifiés par une trame et une marque ▲ sont critiques pour la sécurité. Ne les remplacer que par une pièce portant le numéro spécifié.

Note: Circled letters (A to Z) are applicable to European models only.

Ref. No.	Part No.	Description
R191, 291	1-214-737-00	(A) 2.2k metal oxide
R192, 292	1-214-739-00	(A) 2.7k metal oxide
R312, 412	1-214-753-00	(A) 10k metal oxide
R313, 413	1-214-741-00	(A) 3.3k metal oxide
R502	▲1-214-856-00	(B) 470 $\frac{1}{2}$ W metal oxide
R503	▲1-214-862-00	(B) 820 $\frac{1}{2}$ W metal oxide
R505	▲1-214-856-00	(B) 470 $\frac{1}{2}$ W metal oxide
R506	▲1-214-862-00	(B) 820 $\frac{1}{2}$ W metal oxide
R532, 533	▲1-244-849-00	(A) 100 $\frac{1}{2}$ W carbon
R802	▲1-212-867-00	(A) 27 $\frac{1}{4}$ W fusible
R805	▲1-247-240-00	(A) 1k $\frac{1}{2}$ W carbon (nonflammable)
R806	▲1-217-379-00	(B) 2.2 $\frac{1}{4}$ W fusible
R814, 820	▲1-212-857-00	(A) 10 $\frac{1}{4}$ W fusible
R922	▲1-246-433-00	(A) 22 $\frac{1}{4}$ W carbon
RV001, 011	1-226-721-00	(D) 100k/100k-A, variable; BIAS CAL
RV101, 201	1-224-645-XX	(B) 10k-B, adjustable; playback level
RV102		
RV104, 204	1-226-235-00	(A) 5k-B, adjustable; level meter
RV105, 205	1-226-560-00	(C) 5k-B, variable; REC LEVEL CAL
RV106, 206	1-224-646-XX	(B) 22k-B, adjustable; record level
RV301, 401	1-226-722-00	(E) 20k/20k-A, variable; REC LEVEL
RV502, 503	1-226-232-00	(B) 500-B, adjustable
RV1001	1-226-433-00	(D) 50k-B, adjustable; tape speed

MISCELLANEOUS

CP901	▲1-231-326-11	(B) Encapsulated Component (US model)
	▲1-231-341-00	(C) Spark Killer (Canadian model)
	▲1-231-341-00	(C) Encapsulated Component (E model)
CNJ101, 102	1-507-531-00	(C) Jack, LINE IN, LINE OUT (fixed)
CNJ201, 202		
CNJ103, 203	1-507-526-21	(B) Jack, LINE OUT (variable)
CNJ301	1-507-553-00	(C) Jack, HEADPHONES
CNJ302	1-507-525-00	(D) Jack, MIC
CNJ901	1-561-293-00	(D) Socket, 4p; REMOTE
CNJ902	▲1-526-528-00	Socket, AC OUTLET (US, Canadian model)
HE	8-825-604-00	(F) Head, erase; EF206-36
HRP	8-825-728-00	(U) Combination Head, record/playback; RPF202-3602A
L101, 201	1-407-240-00	(B) 22mH, inductor, variable
L102, 202	1-408-259-00	(B) 15mH, microinductor

Note: The components identified by shading and mark ▲ are critical for safety. Replace only with part number specified.

• Items marked "●" are not stocked since they are seldom required for routine service. Some delay should be anticipated when ordering these items.

Ref. No.	Part No.	Description
L301, 401	1-408-253-00	(B) 4.7mH, microinductor
L302, 402	1-408-250-00	(B) 2.7mH, microinductor
L303, 403		
L304, 404	1-408-249-00	(B) 2.2mH, microinductor
LPF101, 201	1-231-388-00	(D) Filter, lowpass
PL1, 2	1-518-340-71	(B) Lamp, cassette; meter
PL101, 201	1-518-386-00	(B) Lamp, meter
PM1	1-454-222-11	(D) Solenoid, brake
PM2	1-454-222-21	(D) Solenoid, head
M1	X-3564-017-0	(K) Motor Ass'y, capstan
M2	X-3564-015-0	(I) Motor Ass'y, reel
S101	1-552-907-00	(D) Switch, slide; MONITOR
S102	1-552-964-00	(D) Switch, rotary; CALIBRATION
S103	1-552-879-00	(C) Switch, pushbutton; INPUT SELECT
S104	1-552-880-00	(C) Switch, slide; DOLBY NR
S105	1-552-878-00	(D) Switch, slide; EQ
S106	1-552-877-00	(C) Switch, slide; BIAS
S107	1-552-876-00	(D) Switch, pushbutton; REAK HOLD RESET
S108	1-553-254-00	(D) Switch, rotary; LINE OUT/PHONES (AEP, E, UK model)
S801	▲1-552-530-00	Switch, pushbutton; POWER (US, Canadian model)
	▲1-552-903-00	(D) Switch, pushbutton; POWER (AEP, E, UK model)
S802-808	1-552-919-00	(K) Switch, block; function
S809		(K) included in tape counter
S810, 811	1-552-520-00	(C) Switch, slide; MEMORY, timer
S812, 813	1-552-268-00	(B) Switch, slide, accidental-erasure prevention, cassette
T301	1-433-213-21	(C) Transformer, osc
T901	▲1-446-350-00	Transformer, power (US, Canadian model)
	▲1-446-351-00	(M) Transformer, power (AEP, UK model)
	▲1-446-518-00	Transformer, power (E model)
	●1-508-878-00	(A) Base Post, MCD Connector
	●1-508-879-00	(B) Base Post, MCD Connector
	▲1-526-576-21	Voltage Selector (E model)
	▲1-534-777-00	(D) Cord, power (UK model)
	▲1-534-817-XX	(D) Cord, power; euro-plug (AEP, E model)
	▲1-534-986-XX	Cord, power (US, Canadian model)
	●1-535-116-00	(A) Terminal with base post 3p
	▲1-551-473-31	Cord, power; parallel-blade plug (E model)
	●1-560-060-00	(A) Connector Pin

Note: Les composants identifiés par une trame et une marque ▲ sont critiques pour la sécurité. Ne les remplacer que par une pièce portant le numéro spécifié.

Ref. No. Part No. Description

- ♣ 1-560-061-00 (A) Connector Pin
- ♣ 1-560-062-00 (B) Connector Pin
- ♣ 1-560-064-00 (B) Connector Pin
- ♣ 1-561-378-00 (B) Connector Pin 3p
- ♣ 1-561-379-00 (B) Connector Pin 4p
- ♣ 1-561-380-00 (B) Connector Pin 5p

COMPLETE CIRCUIT BOARDS

- ♣ A-2010-153-A Record/Playback
- ♣ A-2019-097-A (S) System Control
- ♣ A-2020-051-A Servo Amp/Mic Amp/Control
- ♣ A-2022-028-A Mic Amp/Control
- ♣ A-2029-039-A (L) Meter

PRINTED CIRCUIT BOARDS

- ♣ 1-600-821-00 (H) Record/Playback
- ♣ 1-600-822-00 (C) Microphone Amp
- ♣ 1-600-823-00 (C) Switch
- ♣ 1-600-824-00 (B) CAL Control
- ♣ 1-600-825-00 (B) Variable Line Out
- ♣ 1-600-826-00 (C) Record EQ
- ♣ 1-600-827-00 (C) Meter
- ♣ 1-600-828-00 (B) Peak Reset Switch
- ♣ 1-600-829-00 (H) System Control
- ♣ 1-600-831-00 (B) Memory Switch
- ♣ 1-600-832-00 (B) Timer Switch
- ♣ 1-600-833-00 (B) Shut-off
- ♣ 1-601-715-00 (B) BIAS Trimmer
- ♣ 1-601-716-00 (B) BIAS CAL Control
- ♣ 1-602-121-00 (B) LINE OUT SW

ACCESSORIES AND PACKING MATERIALS

Part No.	Description
X-3701-105-0	(A) Tip Ass'y, head cleaning
1-551-734-11	(D) Cord, connection; RK-74A
3-561-142-00	Cushion, upper-front (Canadian model)
3-561-143-00	Cushion, upper-rear (Canadian model)
3-561-144-00	Cushion, bottom-right (Canadian model)
3-561-145-00	Cushion, bottom-left (Canadian model)
3-566-148-00	(B) Cushion, upper-front (US, AEP, UK, E model)
3-566-149-00	(B) Cushion, upper-rear (US, AEP, UK, E model)
3-566-150-00	(B) Cushion, bottom-right (US, AEP, UK, E model)
3-566-151-00	(B) Cushion, bottom-left (US, AEP, UK, E model)
3-567-250-00	Carton (E model)
3-701-630-00	(A) Bag, plastic
3-703-157-01	(A) Label, destination
3-783-186-11	Manual, instruction (AEP, UK, E model)
3-783-186-21	Manual, instruction (US model)
3-794-826-31	Manual, instruction (Canadian model)
3-793-481-12	(A) Leaflet
3-793-828-11	(A) Caution Card, cassette
3-794-826-31	Leaflet (Canadian model)
4-860-421-00	(B) Bag, protection

ELECTROLYTIC CAPACITORS

Note: Circled letter (A to Z) are applicable to European models only.

CAP. (μF)	RATING					
	6.3 VOLT.	10 VOLT.	16 VOLT.	25 VOLT.	35 VOLT.	50 VOLT.
	PART No.	PART No.	PART No.	PART No.	PART No.	PART No.
0.47						1-121-726-00 (A)
1.0						1-121-391-00 (A)
2.2						1-121-450-00 (A)
3.3	→	→	→	1-121-392-00 (A)	→	1-121-393-00 (A)
4.7	→	→	→	1-121-395-00 (A)	→	1-121-396-00 (A)
10	→	→	1-121-651-00 (A)	1-121-398-00 (A)	→	1-121-738-00 (A)
22	→	→	1-121-479-00 (A)	1-121-480-00 (A)	1-121-662-00 (A)	1-121-152-00 (A)
33	→	→	1-121-403-00 (A)	1-121-404-00 (A)	1-121-652-00 (B)	1-121-405-00 (A)
47	→	1-121-352-00 (A)	1-121-409-00 (A)	1-121-410-00 (A)	1-121-653-00 (B)	1-121-411-00 (A)
100	→	1-121-414-00 (A)	1-121-415-00 (A)	1-121-416-00 (A)	1-121-357-00 (B)	1-121-417-00 (B)
220	1-121-419-00 (B)	1-121-420-00 (B)	1-121-421-00 (A)	1-121-422-00 (B)	1-121-261-00 (C)	1-121-423-00 (B)
330	1-121-751-00 (B)	1-121-805-00 (B)	1-121-521-00 (C)	1-121-654-00 (B)	1-121-655-00 (D)	1-121-656-00 (C)
470	1-121-424-00 (B)	1-121-425-00 (C)	1-121-426-00 (C)	1-121-733-00 (B)	1-121-361-00 (E)	1-121-810-00 (D)
1000		1-121-736-00 (C)	1-121-245-00 (D)	1-121-657-00 (D)	1-121-388-00 (E)	1-123-061-00 (F)
2200	1-121-658-00 (B)	1-121-659-00 (C)	1-121-660-00 (D)	1-123-067-00 (E)	1-121-984-00 (F)	
3300	1-121-661-00 (D)	1-123-075-00 (E)	1-123-071-00 (F)			

CAP. (μF)	100 VOLT.	160 VOLT.	250 VOLT.	350 VOLT.
	PART No.	PART No.	PART No.	PART No.
0.47				
1.0	1-123-249-00 (A)	1-123-252-00 (A)	1-123-003-00 (B)	1-121-168-00 (B)
2.2	1-123-250-00 (A)	1-123-026-00 (B)		1-123-028-00 (B)
3.3	1-121-995-00 (A)		1-123-004-00 (B)	1-123-006-00 (C)
4.7	1-123-255-00 (A)	1-121-246-00 (B)	1-121-759-00 (B)	1-123-007-00 (D)
10	1-121-126-00 (B)	1-121-999-00 (C)	1-123-254-00 (C)	1-123-008-00 (D)
22	1-121-996-00 (C)	1-123-253-00 (C)	1-123-005-00 (D)	1-123-022-00 (D)
33	1-121-997-00 (C)	1-121-757-00 (C)		
47	1-123 251-00 (C)	1-121-919-00 (C)		
100	1-123-084-00 (E)			

CERAMIC CAPACITORS (A)

CAP. (pF)	RATING						
	50 VOLT.	CAP. (pF)	50 VOLT.	CAP. (pF)	50 VOLT.	CAP. (pF)	50 VOLT.
	PART No.		PART No.		PART No.		PART No.
0.5	1-101-837-00	22	1-102-959-00	150	1-101-361-00	0.001	1-102-074-00
0.75	1-101-586-00	24	1-102-960-00	160	1-101-367-00	0.0012	1-102-118-00
1.0	1-102-934-00	27	1-102-961-00	180	1-102-976-00	0.0015	1-102-119-00
1.5	1-101-576-00	30	1-102-962-00	200	1-102-977-00	0.0018	1-102-120-00
2.0	1-102-935-00	33	1-102-963-00	220	1-102-978-00	0.0022	1-102-121-00
3	1-102-936-00	36	1-102-964-00	240	1-102-979-00	0.0027	1-102-122-00
4	1-102-937-00	39	1-102-965-00	270	1-102-980-00	0.0033	1-102-123-00
5	1-102-942-00	43	1-102-966-00	300	1-102-981-00	0.0039	1-102-124-00
6	1-102-943-00	47	1-101-880-00	330	1-102-820-00	0.0047	1-102-125-00
7	1-102-944-00	51	1-101-882-00	360	1-102-821-00	0.0056	1-102-126-00
8	1-102-945-00	56	1-101-884-00	390	1-102-822-00	0.0068	1-102-127-00
9	1-102-946-00	62	1-101-886-00	430	1-102-823-00	0.0082	1-102-128-00
10	1-102-947-00	68	1-101-888-00	470	1-102-824-00	0.01	1-102-129-00
11	1-102-948-00	75	1-101-890-00	510	1-101-059-00	0.022	1-101-005-00
12	1-102-949-00	82	1-102-971-00	560	1-102-115-00	0.047	1-101-006-00
13	1-102-950-00	91	1-102-972-00	680	1-102-116-00		
15	1-102-951-00	100	1-102-973-00	820	1-102-117-00		
16	1-102-952-00	110	1-102-815-00				
18	1-102-953-00	120	1-102-816-00				
20	1-102-958-00	130	1-101-081-00				

0.001μF = 1,000pF

CERAMIC (SEMICONDUCTOR) CAPACITORS (A)

CAP. (μF)	RATING					
	25 VOLT.	50 VOLT.	CAP. (μF)	25 VOLT.	50 VOLT.	
	PART No.	PART No.	PART No.	PART No.	PART No.	
0.001	→	1-161-039-00	0.018	1-161-016-00	1-161-054-00	
0.0012	→	1-161-040-00	0.022	1-161-017-00	1-161-055-00	
0.0015		1-161-041-00	0.027	1-161-018-00	1-161-056-00	
0.0018		1-161-042-00	0.033	1-161-019-00	1-161-057-00	
0.0022		1-161-043-00	0.039	1-161-010-00	1-161-058-00	
0.0027	→	1-161-044-00	0.047	1-161-021-00	1-161-059-00	
0.0033	→	1-161-045-00	0.056	→	1-161-060-00	
0.0039	→	1-161-046-00	0.068	→	1-161-061-00	
0.0047	→	1-161-047-00	0.082	1-161-024-00	1-161-062-00	
0.0056	→	1-161-048-00	0.1	1-161-025-00	1-161-063-00	
0.0068	→	1-161-049-00				
0.0082	1-161-012-00	1-161-050-00				
0.01	1-161-013-00	1-161-051-00				
0.012	→	1-161-052-00				
0.015	1-161-015-00	1-161-053-00				

Note: Circled letters (A to Z) are applicable to European models only.

• Items marked "♣" are not stocked since they are seldom required for routine service. Some delay should be anticipated when ordering these items.

MYLAR CAPACITORS (A)

Note: Circled letters (A to Z) are applicable to European models only.

CAP. (μF)	RATING																		
	50 VOLT.			100 VOLT.			200 VOLT.			CAP. (μF)	50 VOLT.			100 VOLT.			200 VOLT.		
	PART No.	PART No.	PART No.	PART No.	PART No.	PART No.	PART No.	PART No.	PART No.		PART No.	PART No.	PART No.	PART No.	PART No.	PART No.	PART No.	PART No.	
0.001	1-108-227-00	1-108-365-00	1-108-409-00	0.01	1-108-239-00	1-108-377-00	1-108-421-00	0.1	1-108-251-00	1-108-389-00	1-108-433-00								
0.0012	1-108-351-00	1-108-366-00	1-108-410-00	0.012	1-108-357-00	1-108-378-00	1-108-422-00	0.12	1-108-363-00	1-108-390-00	1-108-434-00								
0.0015	1-108-228-00	1-108-367-00	1-108-411-00	0.015	1-108-240-00	1-108-379-00	1-108-423-00	0.15	1-108-252-00	1-108-391-00	1-108-435-00								
0.0018	1-108-352-00	1-108-368-00	1-108-412-00	0.018	1-108-358-00	1-108-380-00	1-108-424-00	0.18	1-108-364-00	1-108-392-00	1-108-436-00								
0.0022	1-108-230-00	1-108-369-00	1-108-413-00	0.022	1-108-242-00	1-108-381-00	1-108-425-00	0.22	1-108-254-00	1-108-393-00	1-108-437-00								
0.0027	1-108-353-00	1-108-370-00	1-108-414-00	0.027	1-108-359-00	1-108-382-00	1-108-426-00	0.27	1-108-354-00	1-108-385-00	1-108-438-00								
0.0033	1-108-232-00	1-108-371-00	1-108-415-00	0.033	1-108-244-00	1-108-383-00	1-108-427-00	0.33	1-108-355-00	1-108-386-00	1-108-439-00								
0.0039	1-108-354-00	1-108-372-00	1-108-416-00	0.039	1-108-360-00	1-108-384-00	1-108-428-00	0.39	1-108-356-00	1-108-387-00	1-108-440-00								
0.0047	1-108-234-00	1-108-373-00	1-108-417-00	0.047	1-108-246-00	1-108-385-00	1-108-429-00	0.47	1-108-357-00	1-108-388-00	1-108-441-00								
0.0056	1-108-355-00	1-108-374-00	1-108-418-00	0.056	1-108-361-00	1-108-386-00	1-108-430-00												
0.0068	1-108-237-00	1-108-375-00	1-108-419-00	0.068	1-108-249-00	1-108-387-00	1-108-431-00												
0.0082	1-108-356-00	1-108-376-00	1-108-420-00	0.082	1-108-362-00	1-108-388-00	1-108-432-00												



TANTALUM CAPACITORS

CAP. (μF)	RATING							
	→: Use the high voltage rated one.							
	3.15 VOLT.	6.3 VOLT.	10 VOLT.	16 VOLT.	20 VOLT.	25 VOLT.	35 VOLT.	
0.01							1-131-396-00 (B)	
0.015							1-131-397-00 (B)	
0.022							1-131-398-00 (B)	
0.033							1-131-399-00 (B)	
0.047							1-131-400-00 (B)	
0.068							1-131-401-00 (B)	
0.1							1-131-402-00 (B)	
0.15							1-131-403-00 (B)	
0.22							1-131-404-00 (B)	
0.33							1-131-405-00 (B)	
0.47							1-131-406-00 (B)	
0.68							1-131-407-00 (B)	
1.0							1-131-408-00 (B)	
1.5							1-131-409-00 (B)	
2.2	1-131-424-00 (B)	1-131-421-00 (B)	1-131-418-00 (B)	1-131-415-00 (B)	1-131-412-00 (B)	1-131-410-00 (B)	1-131-406-00 (B)	
3.3		1-131-422-00 (B)	1-131-419-00 (B)	1-131-416-00 (B)	1-131-413-00 (B)	1-131-411-00 (B)	1-131-407-00 (B)	
4.7	1-131-425-00 (B)		1-131-420-00 (B)	1-131-417-00 (B)	1-131-414-00 (B)	1-131-412-00 (B)	1-131-408-00 (B)	
6.8		1-131-423-00 (B)	1-131-421-00 (B)	1-131-419-00 (B)	1-131-417-00 (B)	1-131-415-00 (B)	1-131-409-00 (B)	
10	1-131-426-00 (B)	1-131-383-00 (B)	1-131-376-00 (B)	1-131-420-00 (B)	1-131-418-00 (B)	1-131-416-00 (B)	1-131-410-00 (B)	
15	1-131-390-00 (B)	1-131-384-00 (B)	1-131-377-00 (B)	1-131-421-00 (B)	1-131-419-00 (B)	1-131-417-00 (B)	1-131-411-00 (B)	
22	1-131-391-00 (B)	1-131-385-00 (B)	1-131-378-00 (B)	1-131-422-00 (B)	1-131-420-00 (B)	1-131-418-00 (B)	1-131-412-00 (B)	
33	1-131-392-00 (B)	1-131-386-00 (C)	1-131-379-00 (C)	1-131-423-00 (B)	1-131-421-00 (B)	1-131-419-00 (B)	1-131-413-00 (B)	
47	1-131-393-00 (C)	1-131-387-00 (C)	1-131-380-00 (C)	1-131-424-00 (B)	1-131-422-00 (B)	1-131-420-00 (B)	1-131-414-00 (B)	
68	1-131-394-00 (B)	1-131-388-00 (C)	1-131-381-00 (D)	1-131-425-00 (B)	1-131-423-00 (B)	1-131-421-00 (B)	1-131-415-00 (B)	
100	1-131-395-00 (D)			1-131-426-00 (B)	1-131-424-00 (B)	1-131-422-00 (B)	1-131-416-00 (B)	

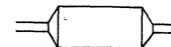

TANTALUM CAPACITORS

CAP. (μF)	RATING						
	3 VOLT.	6.3 VOLT.	10 VOLT.	16 VOLT.	20 VOLT.	35 VOLT.	
	PART No.	PART No.	PART No.	PART No.	PART No.	PART No.	
0.033						1-131-273-00 (E)	
0.047						1-131-274-00 (E)	
0.068						1-131-275-00 (E)	
0.1						1-131-276-00 (E)	
0.15						1-131-277-00 (E)	
0.22						1-131-278-00 (E)	
0.33						1-131-279-00 (E)	
0.47						1-131-280-00 (E)	
0.68			1-131-169-00 (D)			1-131-281-00 (E)	
1.0			1-131-254-00 (D)	1-131-258-00 (D)		1-131-282-00 (E)	
1.5		1-131-250-00 (D)				1-131-283-00 (E)	
2.2						1-131-284-00 (E)	
3.3				1-131-259-00 (D)		1-131-285-00 (E)	
4.7		1-131-251-00 (E)	1-131-255-00 (D)			1-131-286-00 (E)	
6.8			1-131-171-00 (D)			1-131-287-00 (E)	
10				1-131-260-00 (D)		1-131-288-00 (E)	
15			1-131-256-00 (D)			1-131-289-00 (E)	
22				1-131-261-00 (E)		1-131-290-00 (E)	
33	1-131-176-00 (D)	1-131-253-00 (E)	1-131-257-00 (E)			1-131-291-00 (E)	
47	1-131-288-00 (F)	1-131-174-00 (D)	1-131-173-00 (C)			1-131-292-00 (E)	
100	1-131-177-00 (D)					1-131-293-00 (E)	

1/4 WATT CARBON RESISTORS [Ⓐ]

Note: Circled letter [Ⓐ] is applicable to European models only.

Ω	Part No.	Ω	Part No.	Ω	Part No.	Ω	Part No.	Ω	Part No.	Ω	Part No.	Ω	Part No.
1.0	1-246-401-00	10	1-246-425-00	100	1-246-449-00	1.0k	1-246-473-00	10k	1-246-497-00	100k	1-246-521-00	1.0M	1-246-545-00
1.1	1-246-402-00	11	1-246-426-00	110	1-246-450-00	1.1k	1-246-474-00	11k	1-246-498-00	110k	1-246-522-00	1.1M	1-210-814-00
1.2	1-246-403-00	12	1-246-427-00	120	1-246-451-00	1.2k	1-246-475-00	12k	1-246-499-00	120k	1-246-523-00	1.2M	1-210-815-00
1.3	1-246-404-00	13	1-246-428-00	130	1-246-452-00	1.3k	1-246-476-00	13k	1-246-500-00	130k	1-246-524-00	1.3M	1-210-816-00
1.5	1-246-405-00	15	1-246-429-00	150	1-246-453-00	1.5k	1-246-477-00	15k	1-246-501-00	150k	1-246-525-00	1.5M	1-210-817-00
1.6	1-246-406-00	16	1-246-430-00	160	1-246-454-00	1.6k	1-246-478-00	16k	1-246-502-00	160k	1-246-526-00	1.6M	1-210-818-00
1.8	1-246-407-00	18	1-246-431-00	180	1-246-455-00	1.8k	1-246-479-00	18k	1-246-503-00	180k	1-246-527-00	1.8M	1-210-819-00
2.0	1-246-408-00	20	1-246-432-00	200	1-246-456-00	2.0k	1-246-480-00	20k	1-246-504-00	200k	1-246-528-00	2.0M	1-210-820-00
2.2	1-246-409-00	22	1-246-433-00	220	1-246-457-00	2.2k	1-246-481-00	22k	1-246-505-00	220k	1-246-529-00	2.2M	1-210-821-00
2.4	1-246-410-00	24	1-246-434-00	240	1-246-458-00	2.4k	1-246-482-00	24k	1-246-506-00	240k	1-246-530-00	2.4M	1-244-754-00
2.7	1-246-411-00	27	1-246-435-00	270	1-246-459-00	2.7k	1-246-483-00	27k	1-246-507-00	270k	1-246-531-00	2.7M	1-244-755-00
3.0	1-246-412-00	30	1-246-436-00	300	1-246-460-00	3.0k	1-246-484-00	30k	1-246-508-00	300k	1-246-532-00	3.0M	1-244-756-00
3.3	1-246-413-00	33	1-246-437-00	330	1-246-461-00	3.3k	1-246-485-00	33k	1-246-509-00	330k	1-246-533-00	3.3M	1-244-757-00
3.6	1-246-414-00	36	1-246-438-00	360	1-246-462-00	3.6k	1-246-486-00	36k	1-246-510-00	360k	1-246-534-00	3.6M	1-244-758-00
3.9	1-246-415-00	39	1-246-439-00	390	1-246-463-00	3.9k	1-246-487-00	39k	1-246-511-00	390k	1-246-535-00	3.9M	1-244-759-00
4.3	1-246-416-00	43	1-246-440-00	430	1-246-464-00	4.3k	1-246-488-00	43k	1-246-512-00	430k	1-246-536-00	4.3M	1-244-760-00
4.7	1-246-417-00	47	1-246-441-00	470	1-246-465-00	4.7k	1-246-489-00	47k	1-246-513-00	470k	1-246-537-00	4.7M	1-244-761-00
5.1	1-246-418-00	51	1-246-442-00	510	1-246-466-00	5.1k	1-246-490-00	51k	1-246-514-00	510k	1-246-538-00	5.1M	1-244-762-00
5.6	1-246-419-00	56	1-246-443-00	560	1-246-467-00	5.6k	1-246-491-00	56k	1-246-515-00	560k	1-246-539-00		
6.2	1-246-420-00	62	1-246-444-00	620	1-246-468-00	6.2k	1-246-492-00	62k	1-246-516-00	620k	1-246-540-00		
6.8	1-246-421-00	68	1-246-445-00	680	1-246-469-00	6.8k	1-246-493-00	68k	1-246-517-00	680k	1-246-541-00		
7.5	1-246-422-00	75	1-246-446-00	750	1-246-470-00	7.5k	1-246-494-00	75k	1-246-518-00	750k	1-246-542-00		
8.2	1-246-423-00	82	1-246-447-00	820	1-246-471-00	8.2k	1-246-495-00	82k	1-246-519-00	820k	1-246-543-00		
9.1	1-246-424-00	91	1-246-448-00	910	1-246-472-00	9.1k	1-246-496-00	91k	1-246-520-00	910k	1-246-544-00		

HARDWARE NOMENCLATURE

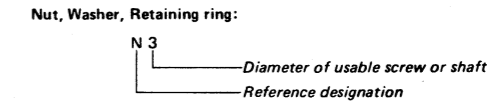
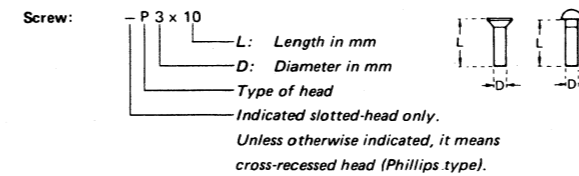

Reference Designation	Shape	Description	Remarks
SCREWS			
P		pan-head screw	binding-head (B) screw for replacement
PWH		pan-head screw with washer face	binding-head (B) screw and flat washer for replacement
PS PSP		pan-head screw with spring washer	binding-head (B) screw and spring washer for replacement
PSW PSPW		pan-head screw with spring and flat washers	binding-head (B) screw and spring and flat washers for replacement
R		round-head screw	binding-head (B) screw for replacement
K		flat-countersunk-head screw	
RK		oval-countersunk-head screw	
B		binding-head screw	
T		truss-head screw	binding-head (B) screw for replacement
F		flat-fillister-head screw	
RF		fillister-head screw	
BV		brazer-head screw	

Reference Designation	Shape	Description	Remarks
SELF-TAPPING SCREWS			
TA		self-tapping screw	ex: TA, P 3 x 10
PTP		pan-head self-tapping screw	binding-head self-tapping (TA, B) screw for replacement
PTPWH		pan-head self-tapping screw with washer face	binding-head self-tapping (TA, B) screw and flat washer for replacement
PTTWH		pan-head thread-rolling screw with washer face	binding-head (B) screw and flat washer for replacement
SET SCREWS			
SC		set screw	
SC		hexagon-socket set screw	ex: SC 2.6 x 4, hexagon socket
NUT			
N		nut	
WASHERS			
W		flat washer	
SW		spring washer	
LW		internal-tooth lock washer	ex: LW3, internal
LW		external-tooth lock washer	ex: LW3, external
RETAINING RINGS			
E		retaining ring	
G		grip-type retaining ring	

Sony Corporation

© 1980
- 46 -

1/4 WATT CARBON RESISTORS [Ⓐ]

Note: Circled letter [Ⓐ] is applicable to European models only.

1.0	1-246-401-00	10	1-246-425-00	100	1-246-449-00	1.0k	1-246-473-00	10k	1-246-497-00	100k	1-246-521-00	1.0M	1-246-545-00
1.1	1-246-402-00	11	1-246-426-00	110	1-246-450-00	1.1k	1-246-474-00	11k	1-246-498-00	110k	1-246-522-00	1.1M	1-210-814-00
1.2	1-246-403-00	12	1-246-427-00	120	1-246-451-00	1.2k	1-246-475-00	12k	1-246-499-00	120k	1-246-523-00	1.2M	1-210-815-00
1.3	1-246-404-00	13	1-246-428-00	130	1-246-452-00	1.3k	1-246-476-00	13k	1-246-500-00	130k	1-246-524-00	1.3M	1-210-816-00
1.5	1-246-405-00	15	1-246-429-00	150	1-246-453-00	1.5k	1-246-477-00	15k	1-246-501-00	150k	1-246-525-00	1.5M	1-210-817-00
1.6	1-246-406-00	16	1-246-430-00	160	1-246-454-00	1.6k	1-246-478-00	16k	1-246-502-00	160k	1-246-526-00	1.6M	1-210-818-00
1.8	1-246-407-00	18	1-246-431-00	180	1-246-455-00	1.8k	1-246-479-00	18k	1-246-503-00	180k	1-246-527-00	1.8M	1-210-819-00
2.0	1-246-408-00	20	1-246-432-00	200	1-246-456-00	2.0k	1-246-480-00	20k	1-246-504-00	200k	1-246-528-00	2.0M	1-210-820-00
2.2	1-246-409-00	22	1-246-433-00	220	1-246-457-00	2.2k	1-246-481-00	22k	1-246-505-00	220k	1-246-529-00	2.2M	1-210-821-00
2.4	1-246-410-00	24	1-246-434-00	240	1-246-458-00	2.4k	1-246-482-00	24k	1-246-506-00	240k	1-246-530-00	2.4M	1-244-754-00
2.7	1-246-411-00	27	1-246-435-00	270	1-246-459-00	2.7k	1-246-483-00	27k	1-246-507-00	270k	1-246-531-00	2.7M	1-244-755-00
3.0	1-246-412-00	30	1-246-436-00	300	1-246-460-00	3.0k	1-246-484-00	30k	1-246-508-00	300k	1-246-532-00	3.0M	1-244-756-00
3.3	1-246-413-00	33	1-246-437-00	330	1-246-461-00	3.3k	1-246-485-00	33k	1-246-509-00	330k	1-246-533-00	3.3M	1-244-757-00
3.6	1-246-414-00	36	1-246-438-00	360	1-246-462-00	3.6k	1-246-486-00	36k	1-246-510-00	360k	1-246-534-00	3.6M	1-244-758-00
3.9	1-246-415-00	39	1-246-439-00	390	1-246-463-00	3.9k	1-246-487-00	39k	1-246-511-00	390k	1-246-535-00	3.9M	1-244-759-00
4.3	1-246-416-00	43	1-246-440-00	430	1-246-464-00	4.3k	1-246-488-00	43k	1-246-512-00	430k	1-246-536-00	4.3M	1-244-760-00
4.7	1-246-417-00	47	1-246-441-00	470	1-246-465-00	4.7k	1-246-489-00	47k	1-246-513-00	470k	1-246-537-00	4.7M	1-244-761-00
5.1	1-246-418-00	51	1-246-442-00	510	1-246-466-00	5.1k	1-246-490-00	51k	1-246-514-00	510k	1-246-538-00	5.1M	1-244-762-00
5.6	1-246-419-00	56	1-246-443-00	560	1-246-467-00	5.6k	1-246-491-00	56k	1-246-515-00	560k	1-246-539-00		
6.2	1-246-420-00	62	1-246-444-00	620	1-246-468-00	6.2k	1-246-492-00	62k	1-246-516-00	620k	1-246-540-00		
6.8	1-246-421-00	68	1-246-445-00	680	1-246-469-00	6.8k	1-246-493-00	68k	1-246-517-00	680k	1-246-541-00		
7.5	1-246-422-00	75	1-246-446-00	750	1-246-470-00	7.5k	1-246-494-00	75k	1-246-518-00	750k	1-246-542-00		
8.2	1-246-423-00	82	1-246-447-00	820	1-246-471-00	8.2k	1-246-495-00	82k	1-246-519-00	820k	1-246-543-00		
9.1	1-246-424-00	91	1-246-448-00	910	1-246-472-00	9.1k	1-246-496-00	91k	1-246-520-00	910k	1-246-544-00		

HARDWARE NOMENCLATURE

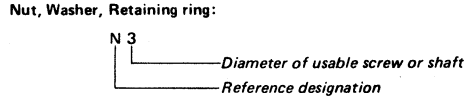
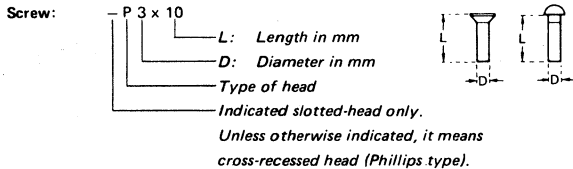

Reference Designation	Shape	Description	Remarks
SCREWS			
P		pan-head screw	binding-head (B) screw for replacement
PWH		pan-head screw with washer face	binding-head (B) screw and flat washer for replacement
P ^S PSP		pan-head screw with spring washer	binding-head (B) screw and spring washer for replacement
PSW PSPW		pan-head screw with spring and flat washers	binding-head (B) screw and spring and flat washers for replacement
R		round-head screw	binding-head (B) screw for replacement
K		flat-countersunk-head screw	
RK		oval-countersunk-head screw	
B		binding-head screw	
T		truss-head screw	binding-head (B) screw for replacement
F		flat-fillister-head screw	
RF		fillister-head screw	
BV		braizer-head screw	

Reference Designation	Shape	Description	Remarks
SELF-TAPPING SCREWS			
TA		self-tapping screw	ex: TA, P 3 x 10
PTP		pan-head self-tapping screw	binding-head self-tapping (TA, B) screw for replacement
PTPWH		pan-head self-tapping screw with washer face	binding-head self-tapping (TA, B) screw and flat washer for replacement
PTTWH		pan-head thread-rolling screw with washer face	binding-head (B) screw and flat washer for replacement
SET SCREWS			
SC		set screw	
SC		hexagon-socket set screw	ex: SC 2.6 x 4, hexagon socket
NUT			
N		nut	
WASHERS			
W		flat washer	
SW		spring washer	
LW		internal-tooth lock washer	ex: LW3, internal
LW		external-tooth lock washer	ex: LW3, external
RETAINING RINGS			
E		retaining ring	
G		grip-type retaining ring	

Sony Corporation

© 1980

- 46 -

MYLAR CAPACITORS (A)

Note: Circled letters (A to Z) are applicable to European models only.

RATING											
CAP. (μF)	50 VOLT.	100 VOLT.	200 VOLT.	CAP. (μF)	50 VOLT.	100 VOLT.	200 VOLT.	CAP. (μF)	50 VOLT.	100 VOLT.	200 VOLT.
	PART No.	PART No.	PART No.		PART No.	PART No.	PART No.		PART No.	PART No.	PART No.
0.001	1-108-227-00	1-108-365-00	1-108-409-00	0.01	1-108-239-00	1-108-377-00	1-108-421-00	0.1	1-108-251-00	1-108-389-00	1-108-433-00
0.0012	1-108-351-00	1-108-366-00	1-108-410-00	0.012	1-108-357-00	1-108-378-00	1-108-422-00	0.12	1-108-363-00	1-108-390-00	1-108-434-00
0.0015	1-108-228-00	1-108-367-00	1-108-411-00	0.015	1-108-240-00	1-108-379-00	1-108-423-00	0.15	1-108-252-00	1-108-391-00	1-108-435-00
0.0018	1-108-352-00	1-108-368-00	1-108-412-00	0.018	1-108-358-00	1-108-380-00	1-108-424-00	0.18	1-108-364-00	1-108-392-00	1-108-436-00
0.0022	1-108-230-00	1-108-369-00	1-108-413-00	0.022	1-108-242-00	1-108-381-00	1-108-425-00	0.22	1-108-254-00	1-108-393-00	1-108-437-00
0.0027	1-108-353-00	1-108-370-00	1-108-414-00	0.027	1-108-359-00	1-108-382-00	1-108-426-00	0.27	1-108-854-00	-	-
0.0033	1-108-232-00	1-108-371-00	1-108-415-00	0.033	1-108-244-00	1-108-383-00	1-108-427-00	0.33	1-108-855-00	-	-
0.0039	1-108-354-00	1-108-372-00	1-108-416-00	0.039	1-108-360-00	1-108-384-00	1-108-428-00	0.39	1-108-856-00	-	-
0.0047	1-108-234-00	1-108-373-00	1-108-417-00	0.047	1-108-246-00	1-108-385-00	1-108-429-00	0.47	1-108-857-00	-	-
0.0056	1-108-355-00	1-108-374-00	1-108-418-00	0.056	1-108-361-00	1-108-386-00	1-108-430-00	-	-	-	-
0.0068	1-108-237-00	1-108-375-00	1-108-419-00	0.068	1-108-249-00	1-108-387-00	1-108-431-00	-	-	-	-
0.0082	1-108-356-00	1-108-376-00	1-108-420-00	0.082	1-108-362-00	1-108-388-00	1-108-432-00	-	-	-	-



TANTALUM CAPACITORS

RATING								→: Use the high voltage rated one.
CAP. (μF)	3.15 VOLT.	6.3 VOLT.	10 VOLT.	16 VOLT.	20 VOLT.	25 VOLT.	35 VOLT.	
	PART No.	PART No.	PART No.	PART No.	PART No.	PART No.	PART No.	
0.01						→		1-131-396-00 (B)
0.015						→		1-131-397-00 (B)
0.022						→		1-131-398-00 (B)
0.033						→		1-131-399-00 (B)
0.047						→		1-131-400-00 (B)
0.068						→		1-131-401-00 (B)
0.1						→		1-131-402-00 (B)
0.15						→		1-131-403-00 (B)
0.22						→		1-131-404-00 (B)
0.33						→	1-131-409-00 (B)	1-131-405-00 (B)
0.47	-	-	-	-	1-131-412-00 (B)	→		1-131-406-00 (B)
0.68	-	-	-	1-131-415-00 (B)	→	1-131-410-00 (B)		1-131-407-00 (B)
1.0	-	-	1-131-418-00 (B)	-	1-131-413-00 (B)	→		1-131-408-00 (B)
1.5	-	1-131-421-00 (B)	-	1-131-416-00 (B)	→	1-131-411-00 (B)		1-131-348-00 (B)
2.2	1-131-424-00 (B)	-	1-131-419-00 (B)	-	1-131-414-00 (B)	1-131-355-00 (B)		1-131-349-00 (B)
3.3	-	1-131-422-00 (B)	-	1-131-417-00 (B)	1-131-362-00 (B)	1-131-356-00 (B)		1-131-350-00 (B)
4.7	1-131-425-00 (B)	-	1-131-420-00 (B)	1-131-369-00 (B)	1-131-363-00 (B)	1-131-357-00 (B)		1-131-351-00 (C)
6.8	-	1-131-423-00 (B)	1-131-376-00 (B)	1-131-370-00 (B)	1-131-364-00 (B)	1-131-358-00 (C)		1-131-352-00 (C)
10	1-131-426-00 (B)	1-131-383-00 (B)	1-131-377-00 (B)	1-131-371-00 (B)	1-131-365-00 (C)	1-131-359-00 (C)		1-131-353-00 (D)
15	1-131-390-00 (B)	1-131-384-00 (B)	1-131-378-00 (B)	1-131-372-00 (B)	1-131-366-00 (C)	1-131-360-00 (D)		-
22	1-131-391-00 (B)	1-131-385-00 (B)	1-131-379-00 (C)	1-131-373-00 (C)	1-131-367-00 (D)			
33	1-131-392-00 (B)	1-131-386-00 (C)	1-131-380-00 (C)	1-131-374-00 (D)				
47	1-131-393-00 (C)	1-131-387-00 (C)	1-131-381-00 (D)					
68	1-131-394-00 (B)	1-131-388-00 (C)						
100	1-131-395-00 (D)							

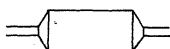

TANTALUM CAPACITORS

RATING						
CAP. (μF)	3 VOLT.	6.3 VOLT.	10 VOLT.	16 VOLT.	20 VOLT.	35 VOLT.
	PART No.	PART No.	PART No.	PART No.	PART No.	PART No.
0.033						1-131-273-00 (E)
0.047						1-131-274-00 (E)
0.068						1-131-275-00 (E)
0.1						1-131-276-00 (D)
0.15						1-131-277-00 (D)
0.22					1-131-262-00 (D)	1-131-278-00 (D)
0.33					1-131-263-00 (D)	1-131-279-00 (D)
0.47			1-131-169-00 (D)		1-131-264-00 (D)	1-131-280-00 (D)
0.68				1-131-254-00 (D)	1-131-265-00 (D)	1-131-281-00 (D)
1.0					1-131-266-00 (D)	1-131-282-00 (D)
1.5		1-131-250-00 (D)			1-131-267-00 (D)	1-131-283-00 (E)
2.2				1-131-259-00 (D)	1-131-268-00 (D)	1-131-284-00 (E)
3.3			1-131-255-00 (D)		1-131-269-00 (D)	
4.7		1-131-251-00 (E)	1-131-171-00 (D)		1-131-270-00 (D)	
6.8				1-131-260-00 (D)	1-131-271-00 (E)	
10			1-131-256-00 (D)		1-131-272-00 (E)	
15		1-131-252-00 (D)		1-131-261-00 (E)		
22			1-131-257-00 (E)			
33	1-131-176-00 (D)	1-131-253-00 (E)	1-131-173-00 (C)			
47	1-131-288-00 (E)	1-131-174-00 (D)				
100	1-131-177-00 (D)					

STEREO CASSETTE DECK

TC-K81

SUPPLEMENT

File this supplement with the service manual.
Add the record head azimuth adjustment as shown page 2.

US Model
Canadian Model
AEP Model
UK Model
E Model

No. 1
September, 1980

Correction
— Page 13 —

Incorrect	Correct
Record/playback Head Azimuth Adjustment	Playback Head Azimuth Adjustment

SONY[®]
SERVICE MANUAL

402

Record Head Azimuth Adjustment

Setting:

MONITOR switch: TAPE

Procedure:

1. Mode: record

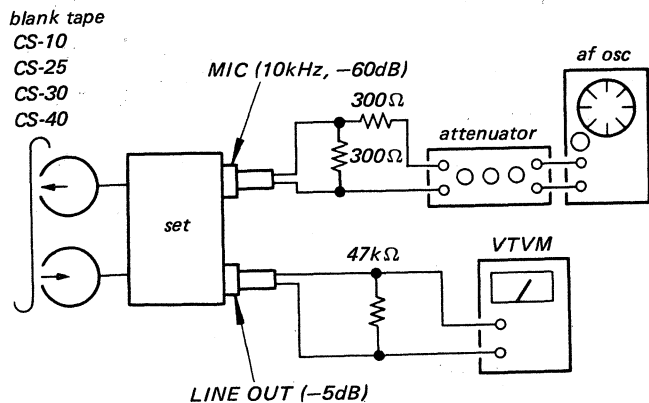

3. Phase Check
Mode: record

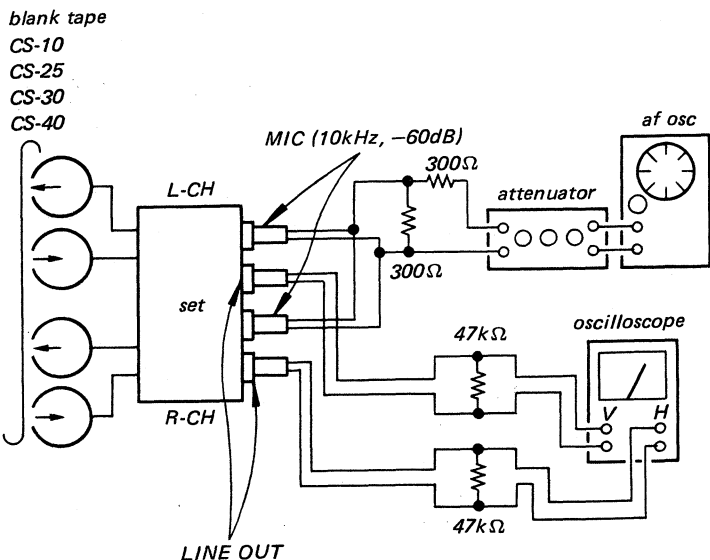

2. Turn the adjustment screw for the maximum output levels. If these levels do not match, turn the adjustment screw where both of output levels match together within 0.5 dB.

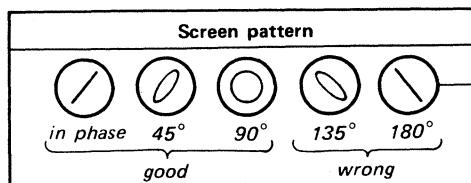
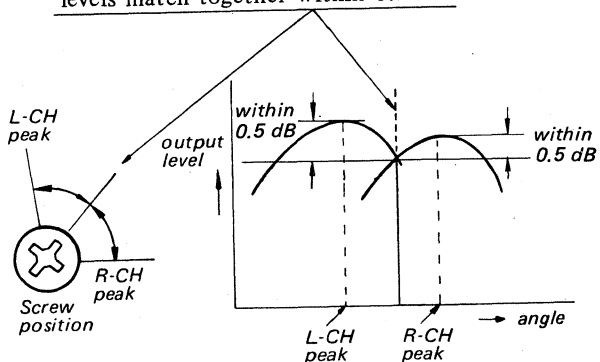

Adjustment Location:

