

DIFFERENTIAL AMP./ EQUALIZER CIRCUIT

A

Q101~104
2SK170
FET DIFFERENTIAL AMP.

D101,102
MA165

C101

C102

C103

C104

C105

C106

C107

C108

C109

C110

C111

C112

C113

C114

C115

C116

C117

C118

C119

C120

C121

C122

C123

C124

C125

C126

C127

C128

C129

C130

C131

C132

C133

C134

C135

C136

C137

C138

C139

C140

C141

C142

C143

C144

C145

C146

C147

C148

C149

C150

C151

C152

C109

C107

C103

C109

C113

C115

C113

C113

C113

C113

C113

C113

C113

C113

C113

C113

C113

C113

C113

C113

C113

C113

C113

C113

C113

C113

C113

C113

C113

C113

C113

C113

C113

C113

C113

C113

C113

C113

C113

C113

C113

C113

C113

C113

C113

C113

C113

C113

C113

C113

C113

C109

C107

C103

C109

C113

C115

C113

C113

C113

C113

C113

C113

C113

C113

C113

C113

C113

C113

C113

C113

C113

C113

C113

C113

C113

C113

C113

C113

C113

C113

C113

C113

C113

C113

C113

C113

C113

C113

C113

C113

C113

C113

C113

C113

C113

C113

C113

C113

C113

C113

C113

C109

C107

C103

C109

C113

C115

C113

C113

C113

C113

C113

C113

C113

C113

C113

C113

C113

C113

C113

C113

C113

C113

C113

C113

C113

C113

C113

C113

C113

C113

C113

C113

C113

C113

C113

C113

C113

C113

C113

C113

C113

C113

C113

C113

C113

C113

C113

C113

C113

C113

C113

C109

C107

C103

C109

C113

C115

C113

C113

C113

C113

C113

C113

C113

C113

C113

C113

C113

C113

C113

C113

C113

C113

C113

C113

C113

C113

C113

C113

C113

C113

C113

C113

C113

C113

C113

C113

C113

C113

C113

C113

C113

C113

C113

C113

C113

C113

C113

C113

C113

C113

C113

C109

C107

C103

C109

C113

C115

C113

C113

C113

C113

C113

C113

C113

C113

C113

C113

C113

C113

C113

C113

C113

C113

C113

C113

C113

C113

C113

C113

C113

C113

C113

C113

C113

C113

C113

C113

C113

C113

C113

C113

C113

C113

C113

C113

C113

C113

C113

C113

C113

C113

C113

C109

C107

C103

C109

C113

C115

C113

C113

C113

C113

C113

C113

C113

C113

C113

C113

C113

MICRO COMPUTER(FUNCTION CONTROL)/INPUT SELECT SWITCH/REC SWITCH/
LED DRIVE/CLOCK GENERATOR CIRCUIT

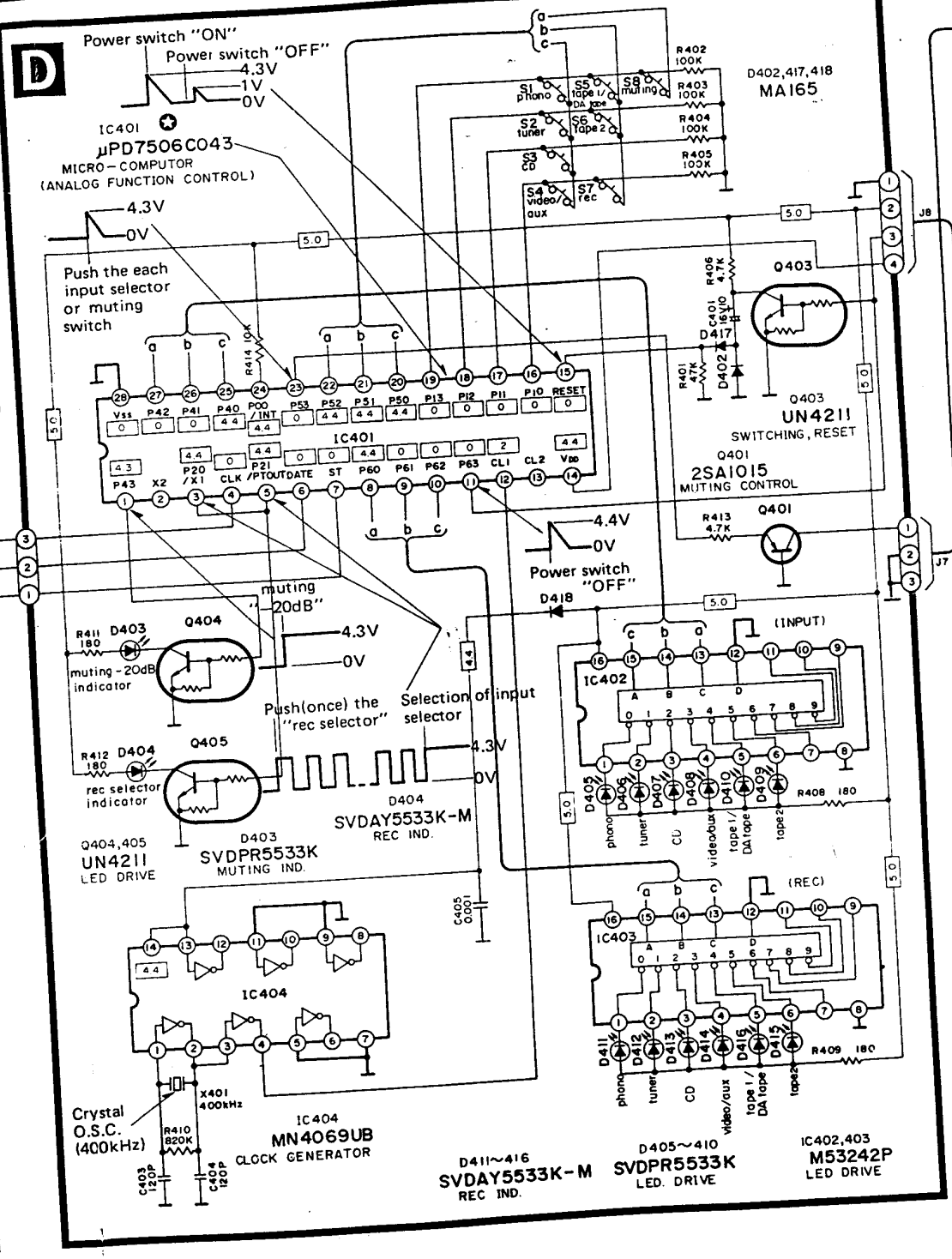
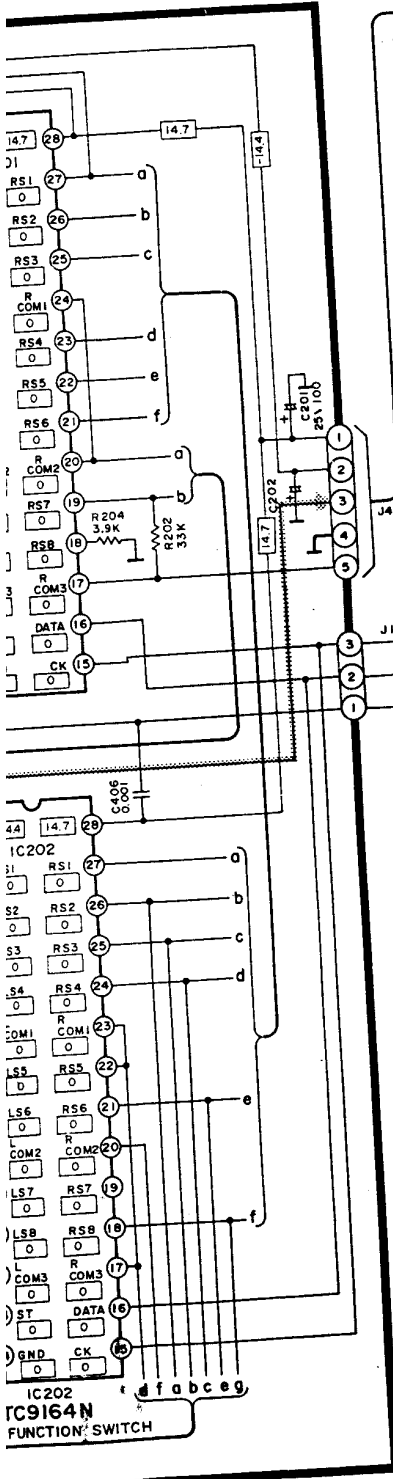

Horvat
Semeljci
856-637
856-139
788-319
t@os.tel.hr

REC SWITCH/

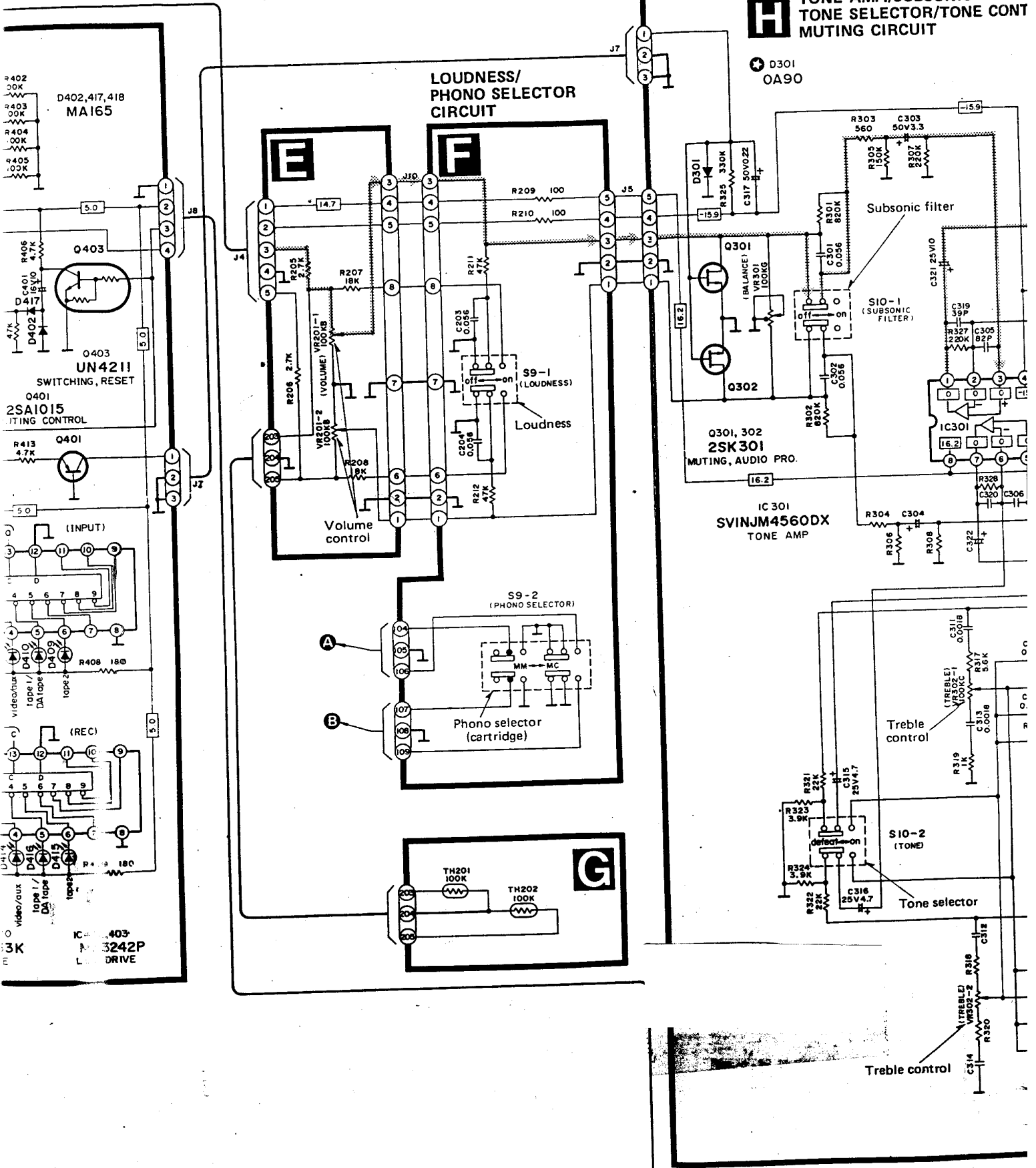

TONE AMP./SUBSONIC FILTER/ TONE SELECTOR/TONE CONTROL/ MUTING CIRCUIT

D301
JA90

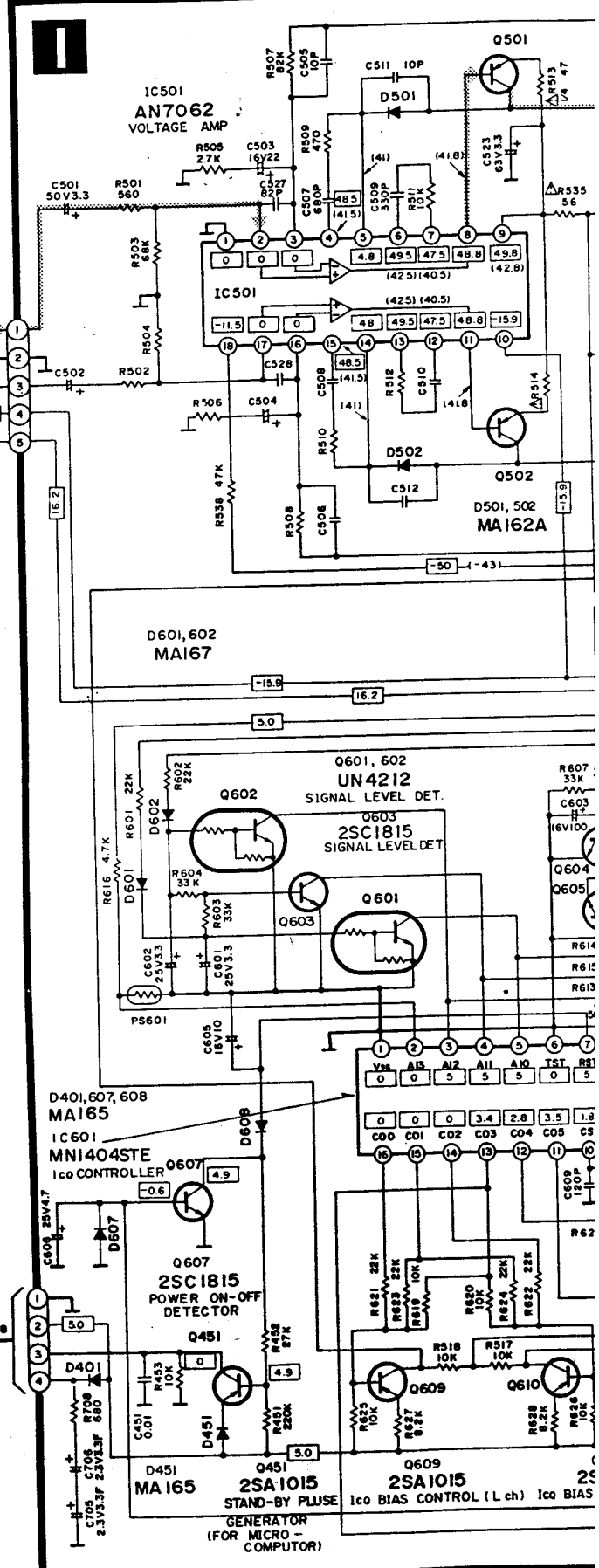
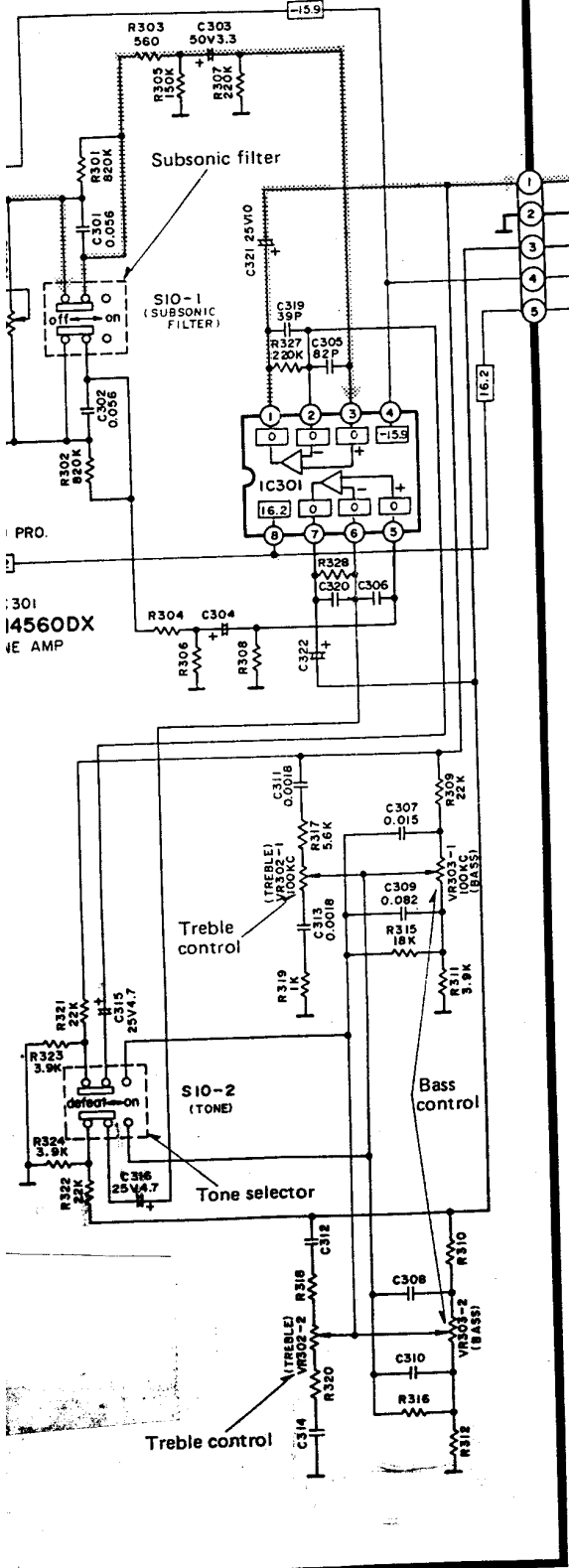

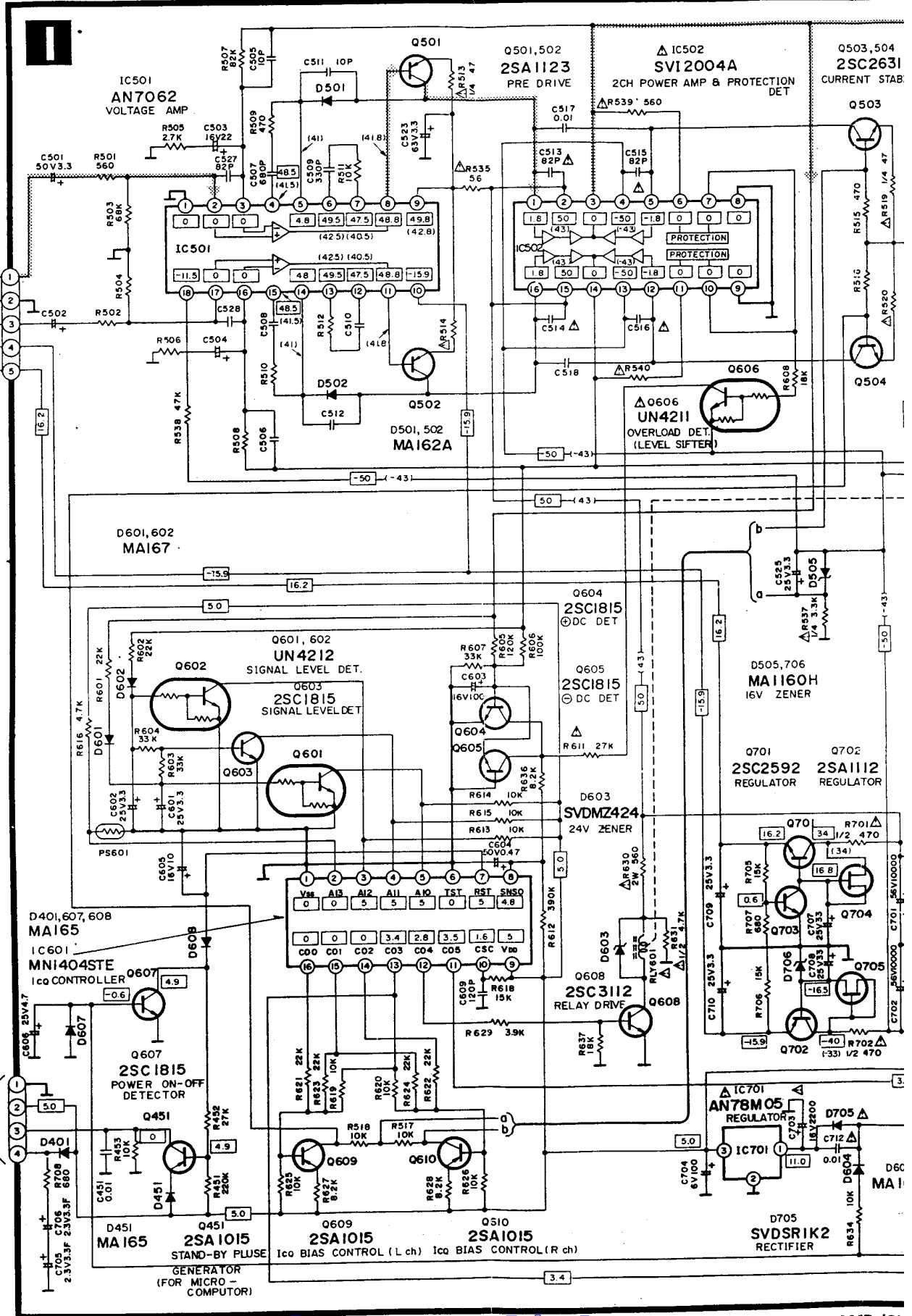

SPEAKER SELECT CIRCUIT

SCHEMATIC DIAGRAM

(This schematic diagram may be modified at any time with the development of new technology).

The part No. of transistors, IC and diodes mentioned in the schematic diagram stand for production part No. Regarding the part No. with \odot mark, the production part No. are different from the replacement part No. Therefore, when placing an order for replacement parts, please use the part No. in the replacement parts list.

Notes:

1. S1~S6 : Input selector switch in "phono" position.
S1: phono, S2: tuner, S3: CD, S4: video/aux, S5: tape 1/DA tape, S6: tape 2
2. S7 : Recording selector switch in "off" position.
3. S8 : Muting switch in "0dB" position. (0dB \leftrightarrow -20dB)
4. S9-1 : Loudness switch in "off" position. (\blacksquare on, \blacktriangle off)
5. S9-2 : Phono selector switch in "MM" position. (\blacksquare MM, \blacktriangle MC)
6. S10-1 : Subsonic filter switch in "off" position. (\blacksquare off, \blacktriangle on)
7. S10-2 : Tone switch in "defeat" position. (\blacksquare defeat, \blacktriangle on)
8. S11-1 : Main speakers selector switch in "on" position. (\blacksquare off, \blacktriangle on)
9. S11-2 : Remote speakers selector switch in "off" position. (\blacksquare off, \blacktriangle on)
10. S12 : Speaker impedance selector switch in "8 Ω ~ 16 Ω /16 Ω " position. (\blacksquare 8 Ω ~ 16 Ω /16 Ω , \blacktriangle 4 Ω ~ 6 Ω /8 Ω)
11. S13 : Power switch in "on" position.
12. S14 : Voltage selector switch in "220V" position.
110V \leftrightarrow 120V \leftrightarrow 220V \leftrightarrow 240V.

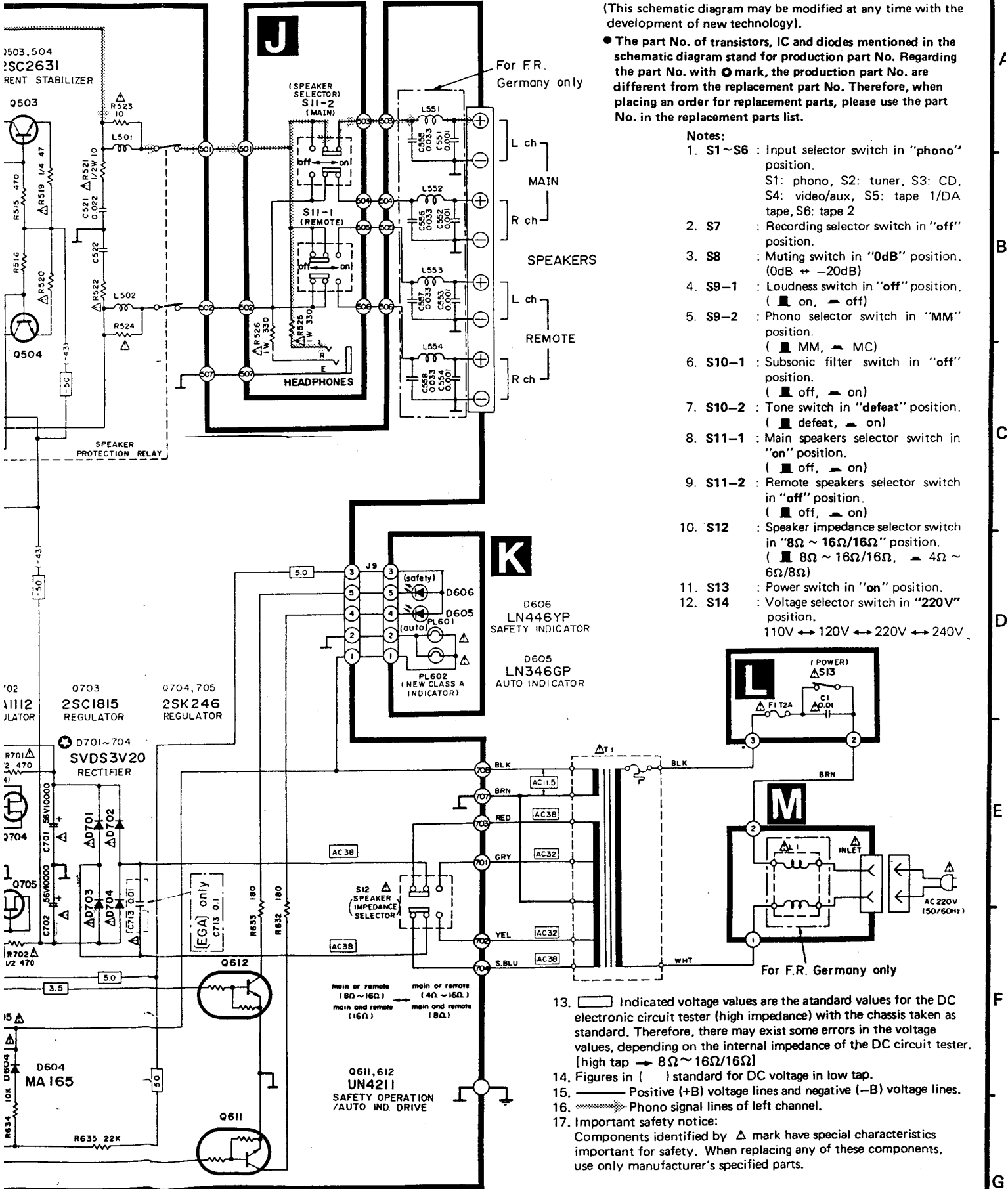

13. \square Indicated voltage values are the standard values for the DC electronic circuit tester (high impedance) with the chassis taken as standard. Therefore, there may exist some errors in the voltage values, depending on the internal impedance of the DC circuit tester. [high tap \rightarrow 8 Ω ~ 16 Ω /16 Ω]
14. Figures in () standard for DC voltage in low tap.
15. --- Positive (+B) voltage lines and negative (-B) voltage lines.
16. --- Phono signal lines of left channel.
17. Important safety notice:
Components identified by Δ mark have special characteristics important for safety. When replacing any of these components, use only manufacturer's specified parts.