

FM Quartz Lock
STEREO RECEIVER

SX-3900

OPERATING INSTRUCTIONS

KU



IMPORTANT NOTICE

The serial number for this equipment is located on the rear panel. Please write this serial number on your enclosed warranty card and keep in a secure area. This is for your security.

WARNING: TO PREVENT FIRE OR SHOCK HAZARD, DO NOT EXPOSE THIS APPLIANCE TO RAIN OR MOISTURE.

Walnut grained vinyl top and side panels are used in the construction of this cabinet.

SAFETY INSTRUCTIONS

READ INSTRUCTIONS — All the safety and operating instructions should be read before the appliance is operated.

RETAIN INSTRUCTIONS — The operating instructions should be retained for future reference.

HEED WARNING — All warnings on the appliance and in the operating instructions should be adhered to.

FOLLOW INSTRUCTIONS — All operating and use instructions should be followed.

WATER AND MOISTURE — The appliance should not be used near water — for example, near a bathtub, washbowl, kitchen sink, laundry tub, in a wet basement, or near a swimming pool, etc.

LOCATION — The appliance should be installed in a stable location.

WALL OR CEILING MOUNTING — The appliance should not be mounted to a wall or ceiling.

VENTILATION — The appliance should be situated so that its location or position does not interfere with its proper ventilation. For example, the appliance should not be situated on a bed, sofa, rug, or similar surface that may block the ventilation openings; or, placed in a built-in installation, such as a bookcase or cabinet that may impede the flow of air through the ventilation openings.

HEAT — The appliance should be situated away from heat sources such as radiators, heat registers, stoves, or other appliances (including amplifiers) that produce heat.

POWER SOURCES — The appliance should be connected to a power supply only of the type described in the operating instructions or as marked on the appliance.

GROUNDING — The precautions that should be taken so that the grounding of an appliance is not defeated.

POWER-CORD PROTECTION — Power-supply cords should be routed so that they are not likely to be walked on or pinched by items placed upon or against them, paying particular attention to cords at plugs, convenience receptacles, and the point where they exit from the appliance.

CLEANING — The appliance should be cleaned only with a polishing cloth or a soft dry cloth. Never clean with furniture wax, benzene, insecticides or other volatile liquids since they may corrode the cabinet.

POWER LINES — An outdoor antenna should be located away from power lines.

NONUSE PERIODS — The power cord of the appliance should be unplugged from the outlet when left unused for a long period of time.

OBJECT AND LIQUID ENTRY — Care should be taken so that objects do not fall and liquids are not spilled into the enclosure through openings.

DAMAGE REQUIRING SERVICE — The appliance should be serviced by Pioneer authorized service center or qualified service personnel when:

- The power-supply cord or the plug has been damaged; or
- Objects have fallen, or liquid has been spilled into the appliance; or
- The appliance has been exposed to rain; or
- The appliance does not appear to operate normally or exhibits a marked change in performance; or
- The appliance has been dropped, or the enclosure damaged.

SERVICING — The user should not attempt to service the appliance beyond that described in the operating instructions. All other servicing should be contacted nearest Pioneer authorized service center.

OUTDOOR ANTENNA GROUNDING — If an outside antenna is connected to the antenna terminal, be sure the antenna system is grounded so as to provide some protection against voltage surges and built up static charges. Section 810 of the National Electrical Code, ANSI/NEPA No. 70-1978, provides information with respect to proper grounding of the mast and supporting structure, grounding of the lead-in wire to an antenna discharge unit, size of grounding conductors, location of antenna-discharge unit, connection to grounding electrodes, and requirements for the grounding electrode. See Fig. A.

EXAMPLE OF ANTENNA GROUNDING AS PER NATIONAL ELECTRICAL CODE INSTRUCTIONS

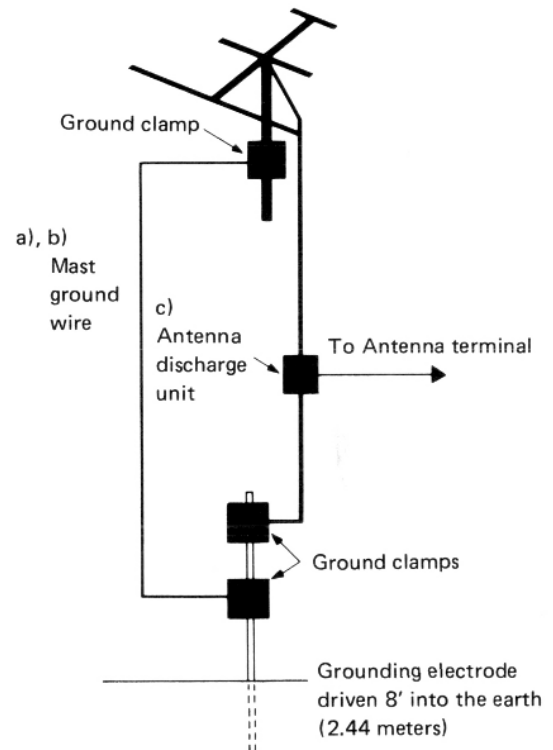

Fig. A

- a) Use No. 10 AWG copper or No. 8 AWG aluminum or No. 17 AWG copper-clad steel or bronze wire, or larger as ground wires for both mast and lead-in.
- b) Secure lead-in wire from antenna to antenna discharge unit and mast ground wire to house with stand-off insulators, spaced from 4 feet (1.22 meters) to 6 feet (1.83 meters) apart.
- c) Mount antenna discharge unit as closely as possible to where lead-in enters house.

CONTENTS

Features	3	Before Operation	13	Tape Deck Operations	16
Rear Panel Facilities	4	FM Reception	13	Using the PREAMP OUT and POWER AMP IN Jacks	17
Connection Diagram	5	AM Reception	14	Specifications	18
Connections	6	Playing Records	14	Troubleshooting	20
Antenna and Ground Connections	8	Using the AUX jacks	14		
Front Panel Facilities	10	Effective Operation	15		

FEATURES

DC-Configured Power Amplifier Using a Non-Switching Amplifier System

Featured in the power amplifier section is a Non-Switching Amplifier system. This is an amplifier with a new type of output stage which controls the output transistor bias at a high speed in accordance with the level of the output signals (with the high-speed bias servo circuit) in order to prevent the output transistors from being set to the cut-off mode. This system ends transistor switching distortion and helps eliminate higher harmonic distortion. Its efficiency is on a par with that of a class B amplifier and it displays the same high level of quality as a class A amplifier. As a result, it delivers a

Continuous Power Output of 120 watts* per channel, min., at 8 ohms from 20 Hertz to 20,000 Hertz with no more than 0.005% total harmonic distortion.

Another feature is the skived heat sink, with a highly efficient heat dissipation effect and a light weight, which has been given a chimney construction. Even when the receiver is being run continuously under full power conditions, this heat sink keeps the temperature rise down and provides high quality and high power listening.

Quartz-locked FM Tuner for Accurate and Stable Reception

The front end employs a 4-gang variable capacitor and dual-gate MOS FET in order to yield a high level of sensitivity and effective interference rejection. Featured in the intermediate frequency stage is three dual element ceramic filters with an outstanding group delay response and a differential amplifier IC between the stages. This configuration helps provide an excellent selectivity and distortion.

The quartz lock system adopts a crystal detector using a quartz crystal as the reference element, and when part of the intermediate frequency signal is passed through this detector, the deviation in the oscillation frequency of the local oscillator caused by shifts in the temperature or humidity is detected and this deviation in the frequency is offset. This means that whatever the frequency, the tuner is fully locked to the signal of the broadcasting station and that stable reception is assured.

The MPX section employs a double chopper type of

demodulator to yield a high signal-to-noise ratio and a low distortion as well as a wide dynamic range. This means that a high separation response is produced even with over-modulation. Another attraction is the adoption of a full auto pilot canceller circuit which tracks the pilot signal level and helps improve the high-range frequency response.

Fluorescent Display Tubes for Power Meter and Frequency Indicator

Featured for the power meter is a fluorescent display tube using the latest digital technology, a logarithmic compression circuit and a peak hold circuit. This combination allows a power output level display from 0.001 watts up to 120 watts without range selection on a bar graph display.

In addition to the conventional dial scale, there is also a reception frequency display based on a fluorescent display tube. This indicates the frequency of the broadcasting station in five digits so that it is easy to tune in a station quickly. The tuning meter and signal meter also use new indicators with fluorescent display tubes.

Preamplifier Guaranteeing High-fidelity Sound Reproduction

The tone amplifier which employs low-noise, low-distortion ICs assures a low distortion of 0.005% (from 20Hz to 20,000Hz, 10V output). The equalizer amplifier also employs low-noise transistors and also high-precision capacitors and resistors to deliver top-notch characteristics such as an RIAA deviation of ± 0.2 dB over 20 to 20,000Hz, a signal-to-noise ratio of 86dB and a maximum allowable input of 300mV.

Full Complement of Accessory Functions

- **Self-illuminating switches:** The function selector and the speaker switches light up when depressed and so exactly what switches have been depressed can be taken in at a glance.
- **Brightness selector:** This selector allows the brightness of the fluorescent display tubes to be adjusted in line with the brightness of the listening room.
- **AM STEREO OUT jack:** Connect your stereo adaptor to this jack when listening to AM stereo broadcasts.

* Measured pursuant to the Federal Trade Commission's Trade Regulation rule on Power Output Claims for Amplifiers.

REAR PANEL FACILITIES

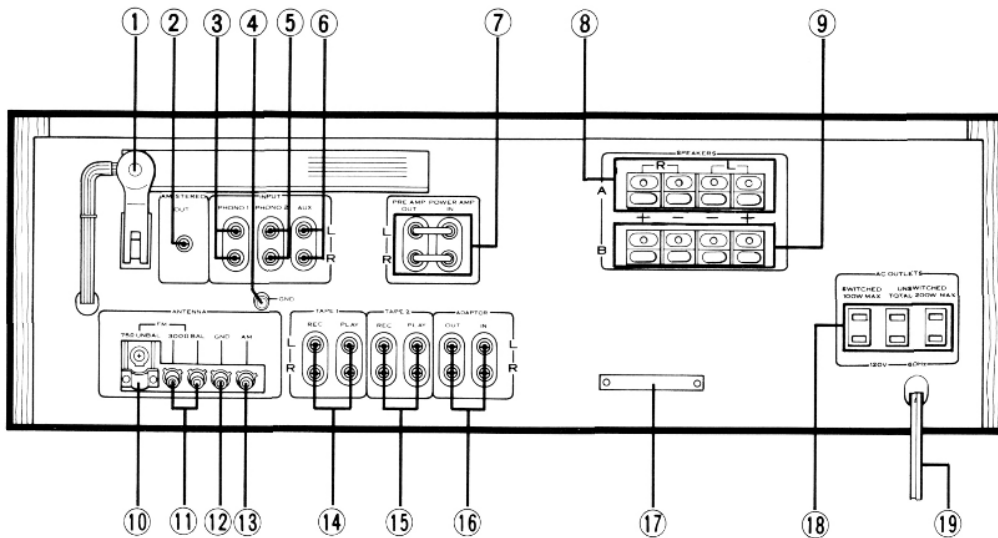

① AM BAR ANTENNA

This antenna is for AM broadcasts. When tuning in an AM station, first use the tuning knob for fine tuning and then move this bar antenna and set it where the optimum reception is obtained. At the same time observe the signal indicator.

For details, refer to "AM ANTENNA" on page 9.

② AM STEREO OUTPUT JACK

This jack is for AM stereo broadcasts. When listening the AM stereo broadcasts, connect the adaptor component to this jack. For further details, refer to the operating instructions of the AM stereo adaptor component.

③ PHONO 1 JACKS

Connect the turntable output cords to these jacks.

④ GND TERMINAL

This is the ground terminal. Connect the ground wire of the turntable, etc. to this terminal.

⑤ PHONO 2 JACKS

Connect your second turntable output cords to these jacks.

⑥ AUX JACKS

These are auxiliary input jacks. Connect a TV tuner or cartridge tape player to them.

⑦ PREAMPLIFIER/POWER AMPLIFIER CONNECTOR BAR

When this connector bar is disconnected from the jacks, you can separate the receiver's preamplifier and power amplifier. For normal use, however, it is connected. For further details on how to use this bar, refer to page 17.

NOTE:

If this bar is not connected properly, you will not hear any sound from the speakers connected to the SPEAKERS terminals.

⑧ SPEAKERS TERMINALS A

Connect your first pair of speakers to these terminals.

⑨ SPEAKERS TERMINALS B

Connect your second pair of speakers to these terminals.

⑩ FM ANTENNA INPUT TERMINAL FOR 75-OHM COAXIAL CABLE

Connect a 75-ohm coaxial cable to this terminal when using it as the feeder from the FM antenna.

⑪ FM ANTENNA INPUT TERMINALS FOR 300-OHM TWIN-LEAD FEEDER

Connect a 300-ohm twin-lead feeder to these terminals when using it as the feeder from the FM antenna. Use these terminals when connecting the accessory T-type FM antenna.

⑫ GND TERMINAL

This is the ground terminal. From aspects of both safety and reduced noise, connect a ground lead to this terminal.

⑬ AM ANTENNA INPUT TERMINAL

When using an external AM antenna, connect it to this terminal.

⑭ TAPE 1 JACKS

Connect the tape deck cords to these jacks.

Connect the REC (recording) jacks to the INPUT jacks on the tape deck, and the PLAY (playback) jacks to the OUTPUT jacks.

15 TAPE 2 JACKS

Connect your second tape deck cords to these jacks.

16 ADAPTOR JACKS

Connect the adaptor component or third tape deck to these jacks.

17 SERIAL NUMBER PLATE

18 AC OUTLETS

These are spare power outlets. Insert the power plug on the stereo components (turntable, tape deck, etc.) into these outlets.

SWITCHED: The power supplied through this

outlet is coupled to the operation of the receiver's power switch. The maximum power capacity which may be connected to this outlet is 100W.

UNSWITCHED: The power is always supplied through these two outlets regardless of the position of the power switch. The maximum power capacity which may be connected to these two outlets is 200W.

19 POWER CORD

Plug this into an AC wall socket.

CONNECTION DIAGRAM

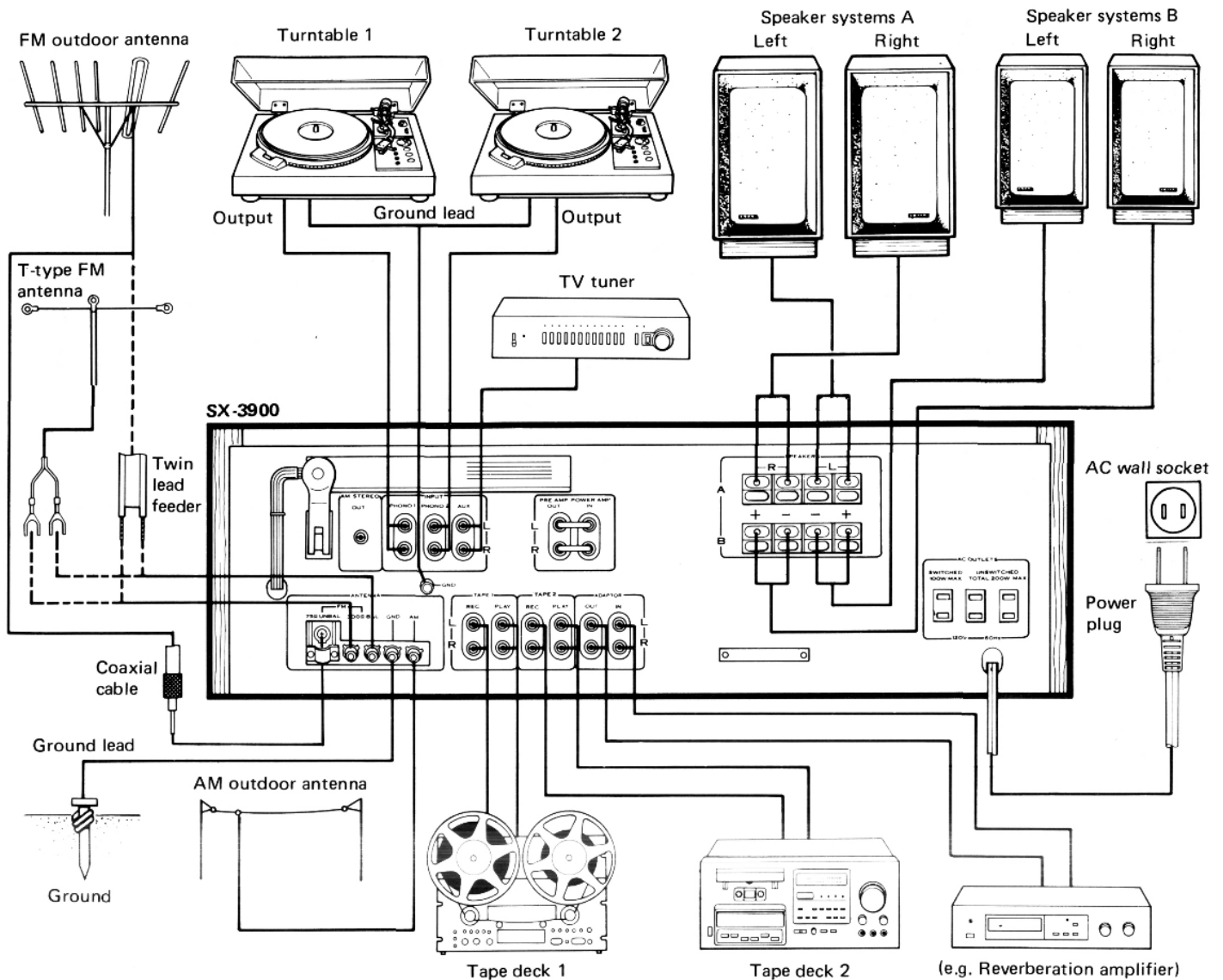

CONNECTIONS

PRECAUTIONS

- Set the POWER switch to ON only when you have completed all the connections of the stereo system. Always set this switch to its bottom position (OFF) if you want to change the connections.
- All the receiver's jacks are aligned for easy connection in two rows: the upper row for L (left channel)

and the lower row for R (right channel). Always connect L to L and R to R with the audio component output and input jacks.

- Make sure that the connections are secure. Improper connections can generate noise or cause the sound to be cut off.

SPEAKER SYSTEM CONNECTIONS (Fig. 1)

The receiver is provided with two sets of SPEAKERS output terminals. Use the A set when connecting only one set of speakers. Viewed from the front, the R (right channel) SPEAKERS terminals are on the right and the L (left channel) SPEAKERS terminals are on the left. Connect the left channel speaker to the L terminals and the right channel speaker to the R terminals.

Cautions when connecting the speakers

1. Do not plug the receiver's power cord into a wall socket before the speakers are fully connected to the SPEAKERS terminals.
2. The speaker output terminals have polarities: minus (brown) and plus (red). The input jacks on the speakers also have plus and minus polarities. When connecting, make sure that these polarities are aligned: plus to plus and minus to minus. If the left and right speaker polarities are misaligned, the reproduced sound will not display a natural stereo effect.
3. Use speakers with a nominal impedance of 4 ohms or more.
If you want to use two sets of speaker system, make sure that the impedance of each system is 8 ohms or more. If the impedance is less than 8 ohms, the protection circuit will be actuated when the volume is turned up and you will not be able to enjoy proper stereo performance.
4. Never use the speakers with the speaker output terminals shorted (minus and plus jacks connected) since this may be damaged the power transistors in the receiver.
5. This receiver delivers a high output power and so make sure that you use speakers with a high allowable input.
6. The high output power of this receiver requires that the speaker lead wires have an ample current carrying capacity. Use wires with a high capacity and connect them securely. If you use low capacity wires and do not connect them properly, the reproduced sound will be adversely affected and heat generation or short circuits may be caused.

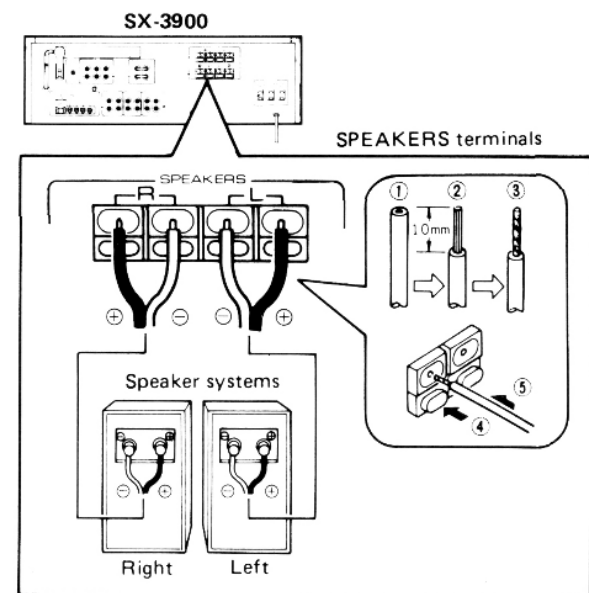

Fig. 1

Processing and connecting the speaker cords

1. Cut off the covering of the speaker cords as shown in Fig. 1.
2. If the strands at the tip of the cord are pointing in all directions, twist them with your thumb and forefinger. Otherwise some of the strands may come into contact with other terminals and cords, and cause a short.
3. Push the minus (brown) button of the speaker terminals with your finger and insert the minus speaker lead into the hole above the button. The lead is locked into position when the button is released. Check that the lead is connected firmly.
4. In the same way, connect the plus speaker lead to the plus terminal (red).
5. Check that the core wires of the speaker leads are not projecting from the terminals. If they should come into contact, this will give rise to a short circuit.

TURNTABLE CONNECTIONS (Fig. 2)

Connect the output cords of a turntable to the PHONO 1 input jacks. Be sure to connect left (L) channel and right (R) channel correctly. Connect the ground lead of the turntable to the GND terminal on the receiver.

NOTES:

1. The way in which the output cords are attached will depend on the type of cartridge used. If you intend to use a low-output moving coil (MC) cartridge, always provide a special MC transformer or a head amplifier.
2. Connect your second turntable to the PHONO 2 input jacks.
3. If your turntable is fitted with two tonearms, the output cords for each the tonearms should be connected to the PHONO 1 and PHONO 2 input jacks.

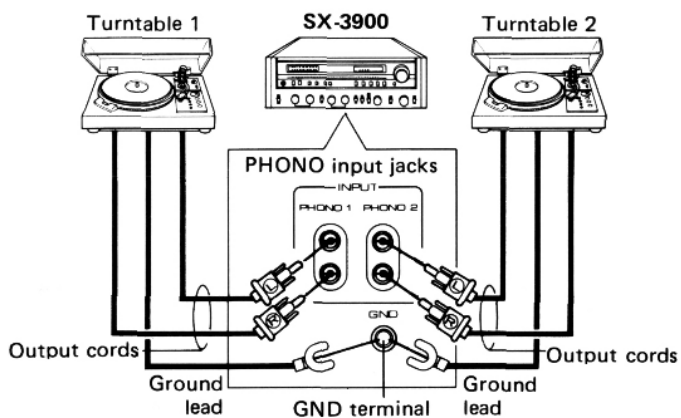

Fig. 2

AUX JACK CONNECTIONS (Fig. 3)

These jacks can be connected to the OUTPUT (PLAY) jacks on a TV tuner, cartridge tape player or tape deck. Use connecting cords with pin plugs to connect the OUTPUT jacks on the component with the AUX jacks. Connect the left channel and right channel properly.

TAPE DECK CONNECTIONS (Fig. 4)

The receiver is provided with two sets of recording (TAPE REC) output jacks and two sets of playback (TAPE PLAY) input jacks. Connect each of the jacks in the following way using the connecting cords which come with the tape deck. The upper row of jacks is for the left channel (L) and the lower row for the right channel (R).

Connections for recording

Connect the recording input jacks (INPUT REC) on the tape deck to the TAPE 1 REC jacks on the receiver.

Connections for playback

Connect the playback output jacks (OUTPUT PLAY) on the tape deck to the TAPE 1 PLAY jacks on the receiver.

NOTE:

Connect your second tape deck to the TAPE 2 jacks (REC, PLAY).

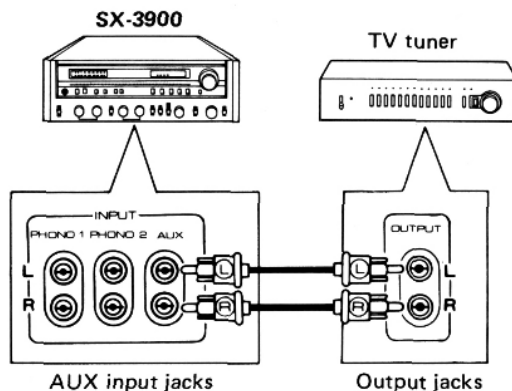

Fig. 3

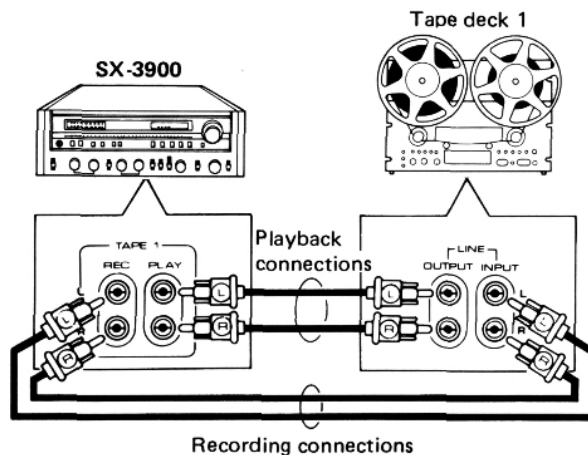

Fig. 4

ADAPTOR JACK CONNECTIONS (Fig. 5)

A third tape deck or other adaptor component (which is connected to the tape terminals on the receiver) can be connected to these terminals.

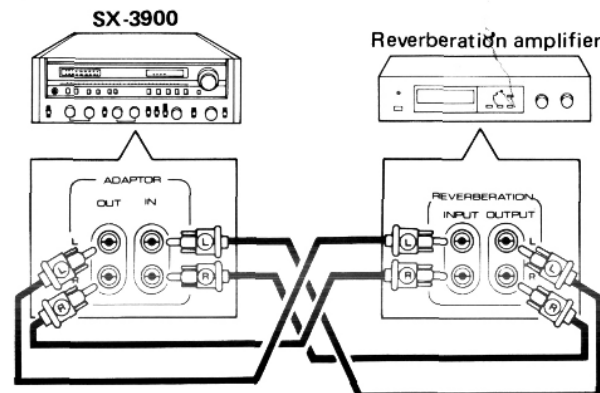

Fig. 5

ANTENNA AND GROUND CONNECTIONS

FM ANTENNAS

There are two methods you can use when connecting the FM antenna to the antenna input terminals: you can use a 300-ohm twin-lead feeder or a 75-ohm coaxial cable.

Pioneer recommends the 75-ohm coaxial cable (RG59U, etc.) if you want your receiver to display its capabilities to the full. The coaxial cable is more effective than the twin-lead feeder in safeguarding against external interference noise from impairing the sound quality. In other words, twin-lead feeders are liable to pick up external noise, and this is why they are not recommended.

CONNECTIONS USING A 75-OHM COAXIAL CABLE

Refer to Fig. 6 and follow the procedure. Prepare the tip of the coaxial cable and connect it to the antenna input terminals (75Ω-UNBAL).

CONNECTIONS USING A 300-OHM TWIN-LEAD FEEDER

In cases where it is only possible to use a twin-lead feeder with a community receiving system antenna, refer to Fig. 6 and follow the procedure. Prepare the ends of the twin-lead feeder and attach them to the 300Ω-BAL antenna input terminals. Then make the twin-lead feeder as short as possible but do not bundle the wires or run them loose on the floor.

ACCESSORY T-TYPE ANTENNA

This antenna is designed to allow you to receive FM programs in areas where strong signals are beamed by broadcasting stations until you install your FM antenna. As shown in Fig. 6, attach the antenna to the 300Ω-BAL antenna input terminals and then tune into an FM station, following the instructions listed under "FM RECEPTION" on page 13. Extend both ends of the antenna horizontally, locate the optimum receiving location by moving the antenna to the left or right, or up or down, and then secure it to the ceiling or wall.

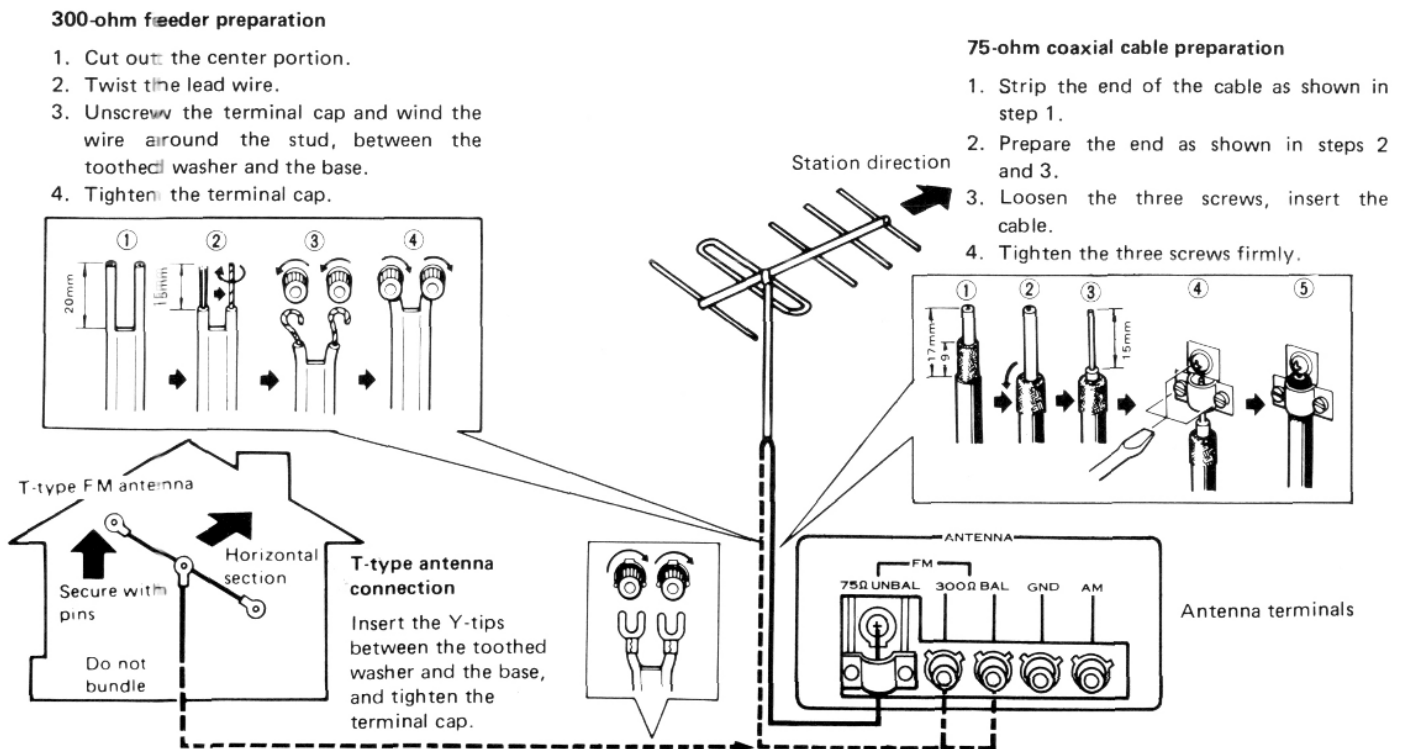

Fig. 6

AM ANTENNAS

While listening to AM stations (see AM RECEPTION on page 14), move the rear panel ferrite bar antenna and position it for best reception.

- Select the desired AM station, and move the bar antenna around in every direction and then set it at the position where the best reception is obtained (Fig. 7).
- In cases when the bar antenna is insufficient for adequate reception, an indoor AM antenna can be made from a length (5 to 6 meters) of vinyl insulated wire as shown in Fig. 8, connect one end of the wire to the AM antenna terminal and suspend the free end from an wall or ceiling at as high a location as possible.
- If reception is still difficult with an indoor antenna, use vinyl insulated wire to erect an outdoor AM antenna between two supports as shown in Fig. 8.

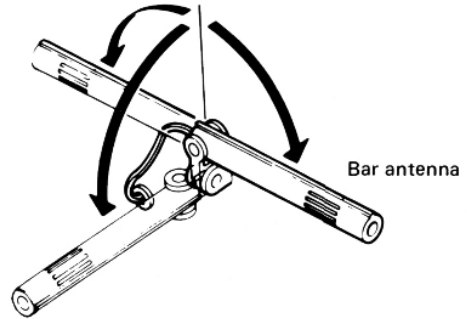

Fig. 7

GROUNDING

From the viewpoint of both safety and reduced noise, Pioneer recommends that you employ a ground as shown in Fig. 8. Connect the ground lead to the GND terminal of the receiver. Never connect it to a gas pipe or other dangerous location.

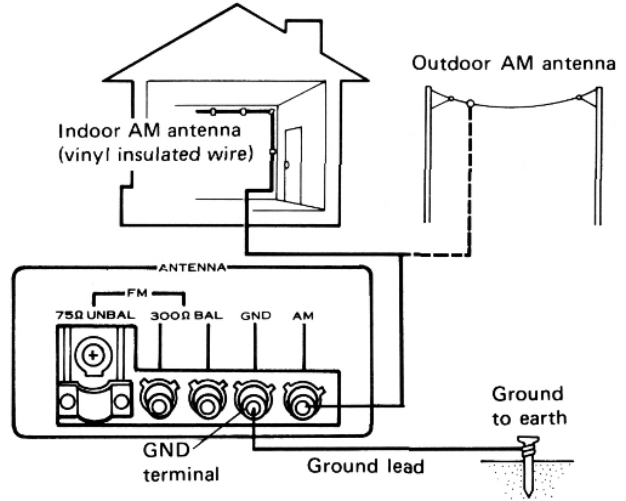

Fig. 8

FM ANTENNA LOCATION

The signals transmitted by an FM broadcasting station inevitably become weak when received behind mountains, between buildings and inside reinforced concrete structures. In weak-signal areas, signals which are reflected off mountains and other obstacles in their path may be picked up by the antenna, which causes a

multipath effect. This adversely affects the sound received. This is why it is necessary to choose an antenna and installation location which are best suited to cope with the ambient conditions and the strength of the signals.

Bear in mind the following points and determine the optimum location (height and direction).

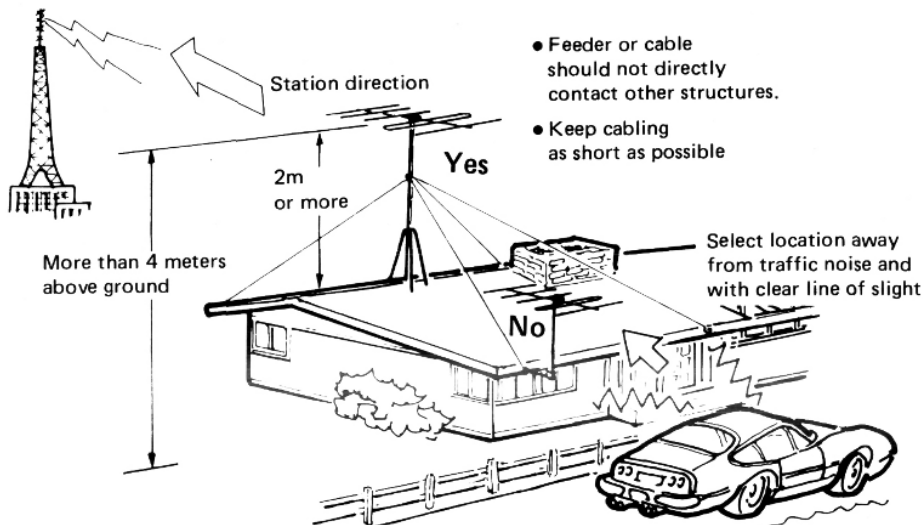

- Feeder or cable should not directly contact other structures.
- Keep cabling as short as possible

Select location away from traffic noise and with clear line of sight

Fig. 9

FRONT PANEL FACILITIES

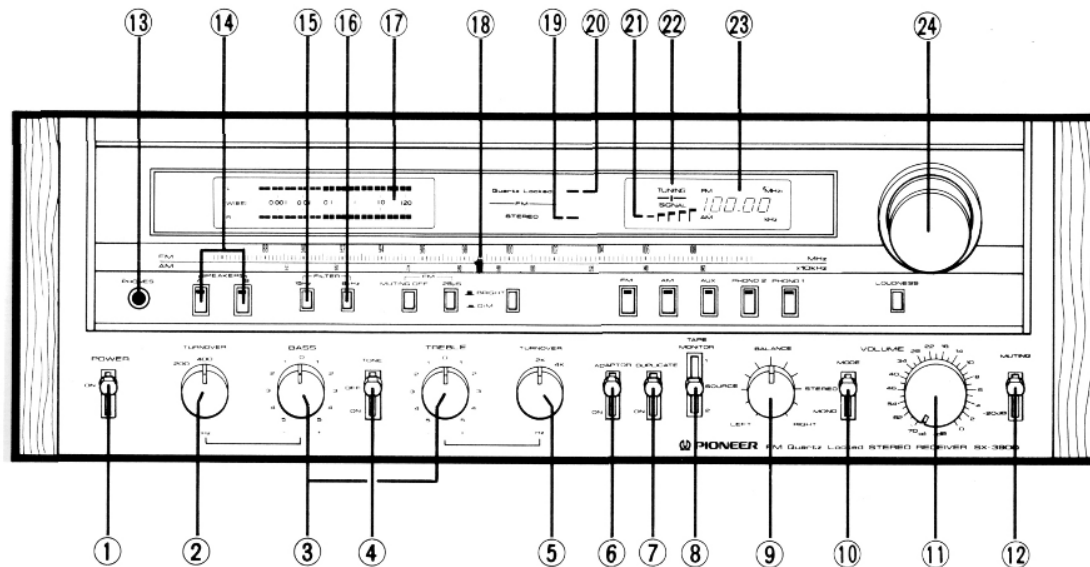

① POWER SWITCH

Set this switch to ON to supply power to the receiver. There will be a short delay when it is set to ON, because the muting circuit has been actuated to suppress the unpleasant noise that is sometimes generated when the power is switched on and off.

② BASS TURNOVER SWITCH

Use this switch to change over the frequency in which the sound adjustment with the bass control is starting to take effect. Select 200Hz or 400Hz in accordance with the characteristics of your listening room and of your speakers, and with your general preference.

③ BASS AND TREBLE CONTROLS

Use these controls to adjust the bass and the treble. If you set the tone switch to ON and turn the bass control to the right from its center position, you will be able to emphasize the sound in a frequency range which is lower than that selected by the bass turnover switch. Conversely, turning this control from the center position to the left will attenuate the sound.

You can use the treble control to adjust the sound in a frequency higher than that selected by the treble turnover switch. For further details, refer to "TURNOVER SWITCHES" on page 15.

④ TONE SWITCH

Set this switch to ON when adjusting the bass and treble controls. When set to the OFF position, the tone control circuits are disengaged and frequency response is flat. This function is convenient for checking phono cartridge and speaker tone quality and listening room acoustics.

⑤ TREBLE TURNOVER SWITCH

Use this switch to change over the frequency in which the sound adjustment with the treble control is starting to take effect. Select 2kHz or 4kHz in accordance with the characteristics of your listening room and of your speakers, and with your general preference.

⑥ ADAPTOR SWITCH

Set this switch to ON when reproducing sound from an optional component which is connected to the ADAPTOR jacks. Always set it to the upper position if you are not using a component with these terminals.

⑦ TAPE DUPLICATE SWITCH

Set this switch to ON when you want to duplicate or edit a pre-recorded tape using two tape decks. For further details, refer to "TAPE DECK OPERATIONS" on page 16.

⑧ TAPE MONITOR SWITCH

Employ for tape playback or to monitor a recording in progress.

1: Playback or monitoring of a tape deck connected to the TAPE 1 jacks.

SOURCE: Be sure to set to this position when not using the tape deck for playback and monitoring.

2: Playback or monitoring of a tape deck connected to the TAPE 2 jacks.

NOTE:

When listening to records or broadcasts, be sure to set this switch to SOURCE. Sound will not be obtained from speakers if it is set to 1 or 2.

⑨ BALANCE CONTROL

Use this control to balance the volume of the left and right channels. First, however, set the mode switch to MONO. If the sound appears to be louder on the right, it means that the volume of the right channel is higher. Turn the balance control to the left and adjust. Conversely, if the sound appears to be louder on the left, it means that the volume of the left channel is higher. Therefore, turn the balance control to the right and adjust. After adjusting, return the mode switch to STEREO.

⑩ MODE SWITCH

Use this switch for selecting mono or stereo performances.

STEREO: Set to this position for normal operations.

MONO: When set to this position, the left and right channel signals will be mixed and reproduced monophonically from both speaker systems.

⑪ VOLUME CONTROL

Use this control to adjust the output level to the speakers and headphones. Turn it clockwise to increase the output level. No sound will be heard if you set it to ∞ . The scale is graduated in dB which indicate the attenuation when the maximum output level is 0dB.

⑫ MUTING SWITCH

Set this switch to the -20dB position to attenuate the audio output indicated by the volume control by 20dB. There is no need to adjust the volume control if you use this switch when turning down the audio output temporarily and when changing over records or tapes.

⑬ HEADPHONE JACK

Plug the headphones into this jack when you want to listen through your stereo headphones.

Release both speaker switches if you want to listen to the sound through your headphones only.

⑭ SPEAKER SWITCHES

Depress the switch corresponding to the speakers connected to the SPEAKERS terminals (A or B) on the rear panel.

You can depress both of these buttons to listen to the sound from two pairs of speaker systems at the same time.

⑮ LOW FILTER SWITCH (15Hz)

Depress this switch in the event that turntable rumble, recording cutting noise or other low frequency noise becomes objectionable. Attenuation in the frequency band below 15Hz is 6dB/octave.

⑯ HIGH FILTER SWITCH (8kHz)

Depress this switch if record scratch noise or other high frequency noise becomes objectionable. Attenuation in the frequency band above 8kHz is 6dB/octave.

⑰ POWER METER

This meter allows you to read out the rated power level on the fluorescent display tube when speakers with a nominal impedance of 8 ohms are connected to the speaker terminals.

⑱ DIAL POINTER

This pointer indicates the broadcasting stations.

⑲ FM STEREO INDICATOR

This indicator lights up when receiving an FM stereo program.

⑳ QUARTZ LOCKED INDICATOR

This indicator lights up after the optimum tuning point has been obtained and displays that the receiving state is stabilized by the built-in quartz lock circuit.

㉑ SIGNAL INDICATOR

This indicator lights in sequence from left through right during the tuning of an AM or FM broadcast in accordance with the strength of the signals being received. The optimum tuning point is where the maximum number of indicators light.

㉒ TUNING INDICATOR

When tuning in an FM station, the optimum reception point is indicated when the center indicator lights up. When the left indicator has come on, rotate the tuning knob slightly clockwise. When the right indicator comes on, rotate the knob slightly counter-clockwise.

㉓ FREQUENCY DISPLAY

This indicates the frequency which is tuned.

With FM reception, the letters "FM" appear on the left of the display and "MHz" on the right. With AM reception, "AM" appears on the left and "kHz" on the right. These change when the function selector position is changed.

㉔ TUNING KNOB

Use this knob to tune in to broadcasting stations.

FRONT PANEL FACILITIES

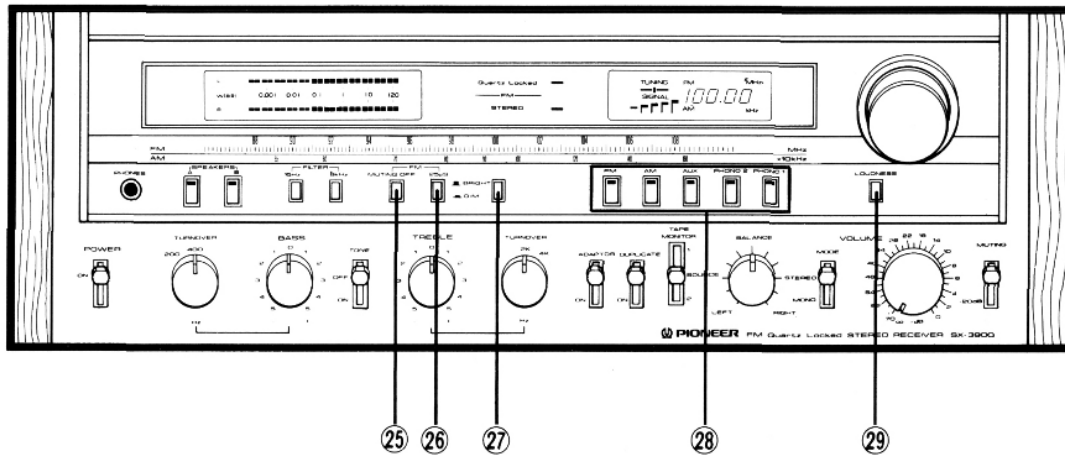

25 FM MUTING OFF SWITCH

When this switch is released, the muting circuit is activated inside to suppress the annoying interstation noise between the broadcasting frequencies for noise-free reception. When the broadcasting station is far away or when receiving a station in a fringe area, set the switch to the OFF position and then tune in. If there is a broadcasting station with a strong signal level on the air next to a station whose program you want to receive, you may not be able to tune in satisfactorily because the sound will be drowned out by the stronger signals. In cases like this, set the FM MUTING OFF switch to OFF (depressed position) and tune in. The muting circuit does not work when the tuner is receiving AM broadcasts. If tuning has been performed after the FM MUTING OFF switch has been depressed and a station selected, the quartz locked circuit is set to the OFF mode and the LOCKED indicator does not light.

26 FM 25µs SWITCH

Depress this switch when listening to a Dolby* FM broadcast; otherwise keep this switch at the released position.

For further details, refer to page 15.

27 BRIGHTNESS SELECTOR

Use this switch to select the brightness of the power meter and the frequency display.

BRIGHT: When using the receiver in daylight or other bright locations.

DIM: At night or in dark locations when the existing brightness is too high.

28 FUNCTION SELECTOR

Depress the function switch which corresponds to the program source. Turn the volume control down first before selecting a different function switch while the sound from one program source is being reproduced.

FM: Depress this switch for FM broadcasts.

AM: Depress this switch for AM broadcasts.

AUX: Depress this switch when listening to an audio component connected to the AUX jacks.

PHONO 2: Depress this switch when playing a record on the turntable connected to the PHONO 2 jacks.

PHONO 1: Depress this switch when playing a record on the turntable connected to the PHONO 1 jacks.

NOTE:

Only one function switch should be depressed at a time.

29 LOUDNESS SWITCH

When listening to a performance with the volume control turned down, depress this switch and the bass and treble will be accentuated.

When the volume is low, the human ear finds it harder to hear the bass and treble than when the volume is high. The loudness switch is thus designed to compensate for this deficiency. By depressing this switch, the bass and treble come through much more strongly and the sound takes on a punch even when the volume control is turned down.

BEFORE OPERATION

PRIOR TO SWITCHING POWER ON

Before switching the power on, set the various controls as follows:

1. Depress the speaker switch that corresponds to the speaker systems which is connected to the SPEAKERS terminals on the rear panel.
2. Release low (15Hz) and high (8kHz) filter switches.
3. Release the FM muting off switch.
4. Release the FM 25 μ S switch.
5. Release the loudness switch.
6. Set the bass and treble controls to the center positions.
7. Set the tone switch to OFF position.
8. Set the adaptor switch to the upper position.
9. Set the tape duplicate switch to the upper position.
10. Set the tape monitor switch to SOURCE position.
11. Set the mode switch to STEREO position.
12. Set the volume control to ∞ position.
13. Set the muting switch to the upper position.

FM RECEPTION

1. Depress the FM function switch.
When the FM function switch is depressed, the letters "FM" and "MHz" are appeared on the frequency display.
2. Slightly turn the volume control clockwise direction to obtain the sound.
3. Rotate the tuning knob and tune in the station whose program you want to listen to. Adjust the knob so that the most signal indicators light up and the center tuning indicator lights up as shown in Fig. 10.
- The quartz locked indicator will light up when the optimum tuning point is obtained. The built-in quartz lock circuit ensures optimum tuning precision.

- The tuned frequency is displayed on the frequency display.
- If the program is being broadcast in stereo, the FM stereo indicator will light up.

NOTE:

When reception is poor even when the frequency display indicates the proper frequency of the broadcasting station, depress the FM muting off switch and tune. If tuning has been performed after the FM MUTING OFF switch has been depressed and a station selected, the quartz locked circuit is set to the OFF mode and the LOCKED indicator does not light.

4. Adjust the volume with the volume control.
5. Set the tone switch to ON in line with your preference and adjust the tone with the tone controls.

Fluorescent display of tuning section
With FM broadcasts



Operating the tuning knob

No reception

Operating the tuning knob

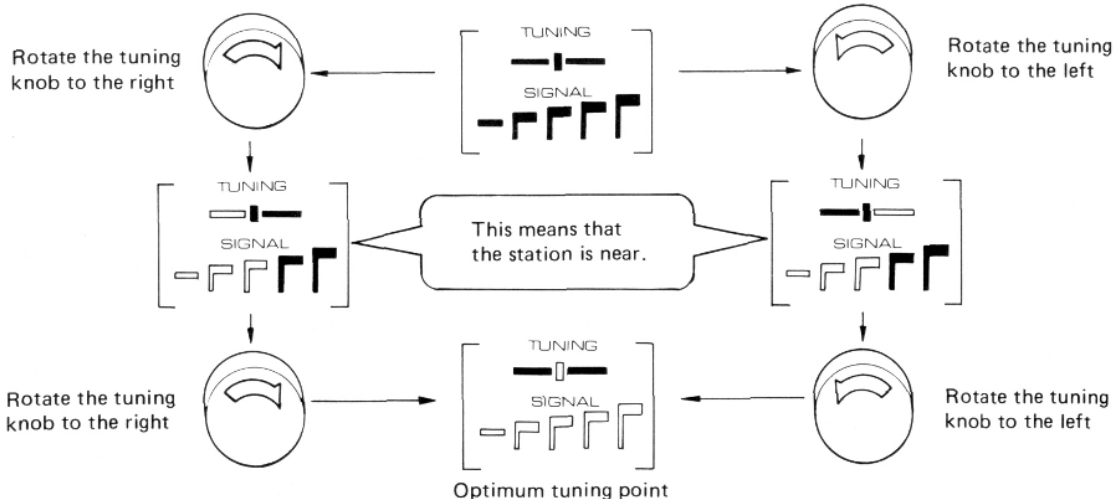

• in the figure indicates "lighted" while indicates "not lighted."

Fig. 10

AM RECEPTION

1. Depress the AM function switch.

When the AM function switch is depressed, the letters "AM" and "kHz" are appeared on the frequency display.

2. Slightly turn the volume control clockwise direction to obtain the sound.
3. Rotate the tuning knob and tune in the station whose program you want to listen to. Adjust the knob so that the most signal indicators light up as in Fig. 11. (Adjust the AM bar antenna at the rear for optimum reception).
4. Adjust the volume with the volume control.
5. Set the tone switch to ON in line with your preference and adjust the tone with the tone controls.

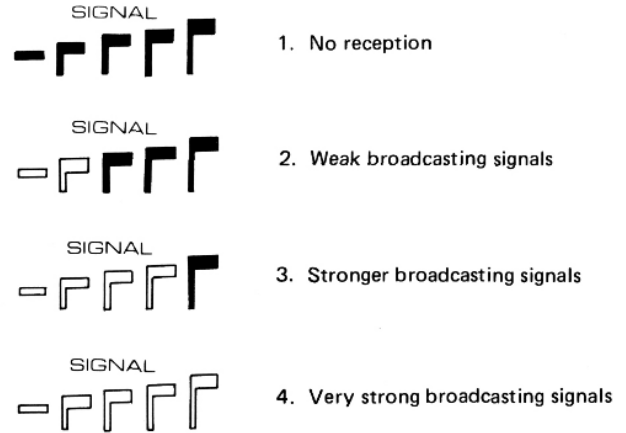
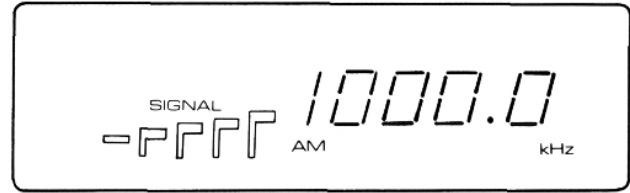

- in the figure indicates "lighted" while indicates "not lighted."

Fig. 11

PLAYING RECORDS

1. If your turntable is connected to the PHONO 1 input jacks, depress the PHONO 1 function switch. If it is connected to the PHONO 2 input jacks, depress the PHONO 2 function switch.
2. Operate the turntable to play the record.
3. Adjust the volume with the volume control.
4. Set the tone switch to ON in line with your preference and adjust the tone with the tone controls.

Precautions when playing records.

- Lower the stylus gently onto the surface of the record. It is a good idea to set the muting switch to -20dB or to turn the volume down when lowering the stylus onto the record.
- Depress the low filter switch if there is a great deal of noise or if the speaker cone paper is seen to be moving despite the fact that you cannot hear the sound during a performance.
- Do not cause the turntable to vibrate while a record is being played since this will cause the stylus to jump and scratch the record. Do not turn off the power if the stylus is still tracing grooves on the record.

USING THE AUX JACKS

1. Depress the AUX function switch.
2. Operate the audio component which you have connected to the AUX jacks.
3. Adjust the volume with the volume control.
4. Set the tone switch to ON in line with your preference and adjust the tone with the tone controls.

EFFECTIVE OPERATION

RECEPTION OF FM DOLBY BROADCASTS

If you live in an area where you can receive FM Dolby broadcasts, you can listen it if you connect an optional Dolby NR adaptor to the ADAPTOR jacks.

1. Connect the Dolby NR adaptor to the ADAPTOR jacks (OUT, IN), as shown in Fig. 12.
2. Depress the FM 25 μ S switch.
3. Set the adaptor switch to ON.
4. Operate the Dolby NR adaptor.
5. Depress the FM function switch and tune in the Dolby broadcast with the tuning knob. For reception, refer to "FM RECEPTION" since the procedure is the same.

NOTES:

- For detailed instructions on connections and the handling of the Dolby adaptor, refer to its operating instructions.
- When you are not listening to an FM Dolby broadcast, return the FM 25 μ S switch and the adaptor switch to their original positions.

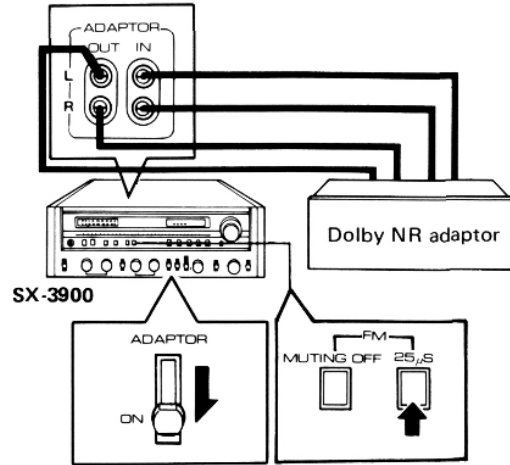

Fig. 12

WHEN USING ADAPTOR COMPONENTS

The ADAPTOR jacks are available in addition to the normal tape REC and PLAY jacks to enable other sophisticated adaptor units (graphic equalizer, reverberation amplifier, etc.) to be connected without disturbing the full tape monitoring and duplicating facility. When using an adaptor, the program source can be taken from the function selector or the tape deck output jacks. Fig. 13 illustrates a reverberation amplifier connected to the ADAPTOR jacks.

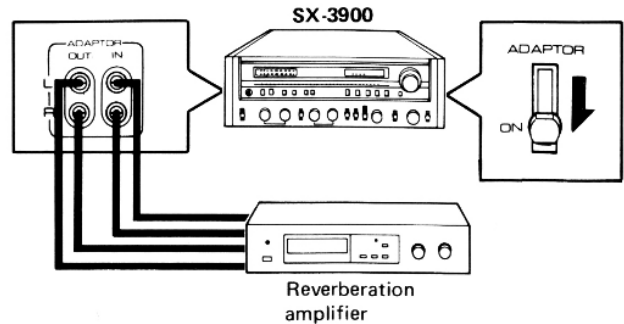

Fig. 13

TURNOVER SWITCHES

As shown in Fig. 14, the receiver adopts a tone control system that combines the bass and treble controls with two turnover switches which are used to select the frequency. Select the frequency with the turnover switches and then enhance or attenuate the sound in the lower (or higher) frequencies with the bass (or treble) controls.

For instance, if the bass turnover switch is set to 400Hz (see Fig. 14), the bass covers a wide frequency spectrum and can be enhanced (or reduced) with large gain per step of the bass control. For this reason, the reproduced sound sometimes seems unnatural depending on the program source, but this can be remedied by setting the switch to 200Hz.

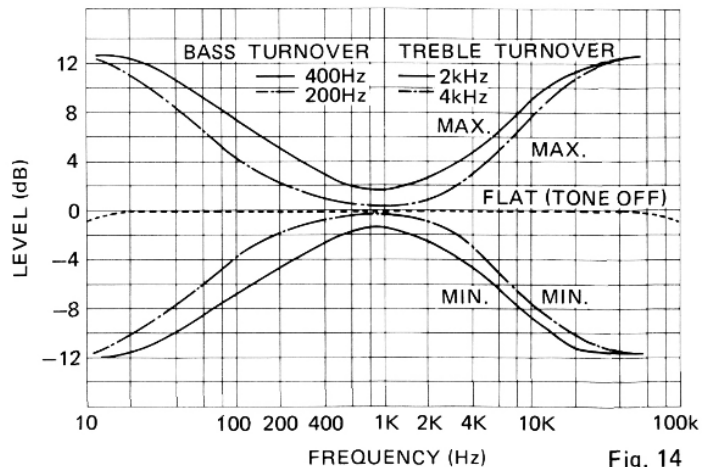
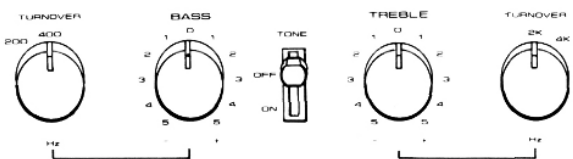

Fig. 14

TAPE DECK OPERATIONS

PLAYBACK (Fig. 15)

1. Set the tape monitor switch to 1 if the tape deck connected to the TAPE 1 jacks. Set the tape monitor switch to 2 if it is connected to the TAPE 2 jacks.
2. Operate the tape deck controls for playback.
3. Adjust the volume with the volume control.
4. Set the tone switch to ON in line with your preference and adjust the tone with the tone controls.

NOTES:

1. Always return the tape monitor switch to SOURCE position when you are not playing back a tape.
2. As long as the tape monitor switch is at 1 or 2, you will be able to play back a tape regardless of the setting of the function selector.
3. If you depress the adaptor switch together, you will hear the playback sound of the tape deck through the adaptor connected to the ADAPTOR jacks.

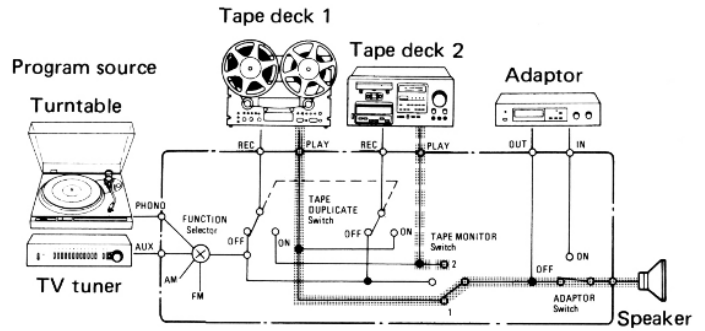

Fig. 15

RECORDING (Fig. 16)

1. Depress the function switch that corresponds to the program source which you intend to record.
2. Set the tape duplicate switch to OFF (upper position).
3. Play the program source (record, FM broadcast, etc.).
4. Set the recording level on the tape deck.
5. Start the recording by following the tape deck's recording procedure.

NOTES:

1. When recording, keep the mode switch at STEREO.
2. The receiver's volume, bass and treble controls have no effect on the recorded sound when a recording is being made.

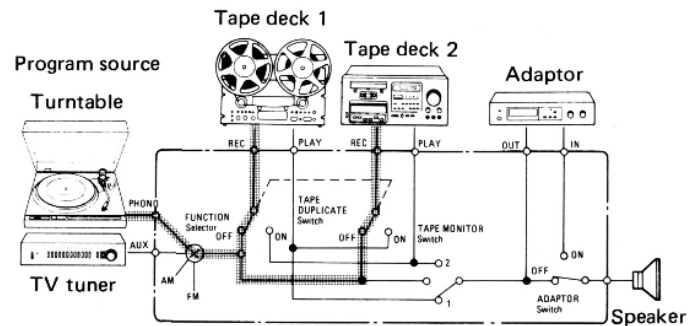

Fig. 16

Tape monitoring

If a recording is being made on a 3-head tape deck, the recorded sound can be monitored through the speaker systems if the tape monitor switch is set to 1 or 2, depending on which TAPE jacks the tape deck is connected to. In this case, both recording and playback connections must be made.

NOTE:

If you have a 2-head open-reel deck or cassette deck, you will not be able to monitor the recorded sound even if you set the tape monitor switch to 1 or 2. However, you will be able to hear the sound at the playback end (program source).

Duplicating and editing recorded tapes

1. As shown in Fig. 17, connect the tape decks to the receiver's TAPE 1 and TAPE 2 jacks.
2. Set the tape duplicate switch to ON.
3. Play back the recorded tape on the tape deck 1 and record it on the tape deck 2. It is also possible to play the tape back on tape deck 2 and record it on the tape deck 1.
4. Set the tape monitor switch to 1 or 2, depending on which tape deck the recording is being made when you want to monitor the recorded sound.

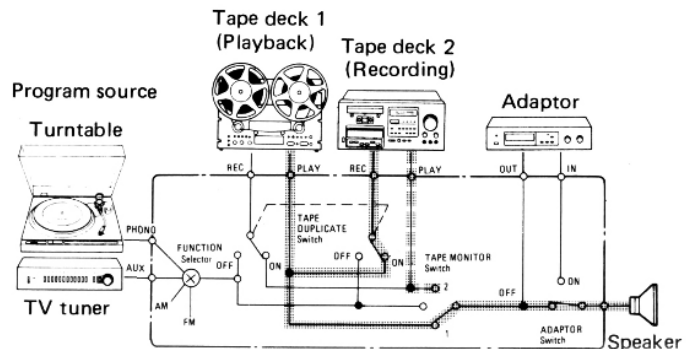

Fig. 17

NOTE:

Do not set both tape decks to the recording mode at the same time.

USING THE PREAMP OUT AND POWER AMP IN JACKS

If the connections between the PREAMP OUT and POWER AMP IN jacks are removed (see Fig. 18), it is possible to use the preamplifier section and the power amplifier section independently. However, for normal use always keep these connections in place because once you remove them, no sound will be heard through the speakers. Always set the power switch to OFF when removing or replacing these connections.

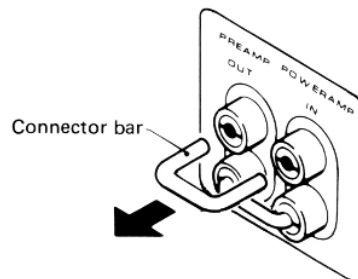

Fig. 18

INDEPENDENT PREAMPLIFIER SECTION

As shown in Fig. 19 you can connect a high output power stereo power amplifier or a homebuilt power amplifier to the PREAMP OUT jacks and compare the sound with the power amplifier section of the stereo receiver.

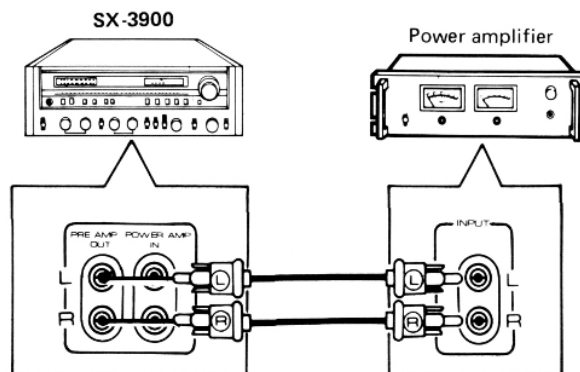

Fig. 19

INDEPENDENT POWER AMPLIFIER SECTION

As shown in Fig. 20, you can connect a stereo preamplifier which you may have to the POWER AMP IN jacks and compose your own stereo system.

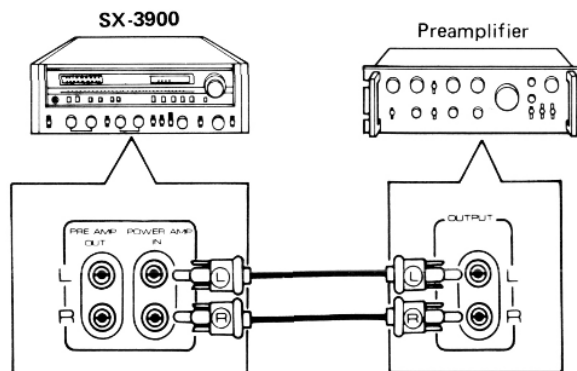

Fig. 20

COMPOSING A MULTI-AMPLIFIER SYSTEM

As shown in Fig. 21, you can compose your own multi-amplifier system if you connect an optional stereo power amplifier and crossover network. A multi-amplifier system splits up the audible frequency range into different frequency bands. Each of these bands is then amplified by the amplifiers and so this has the advantage of reducing intermodulation distortion.

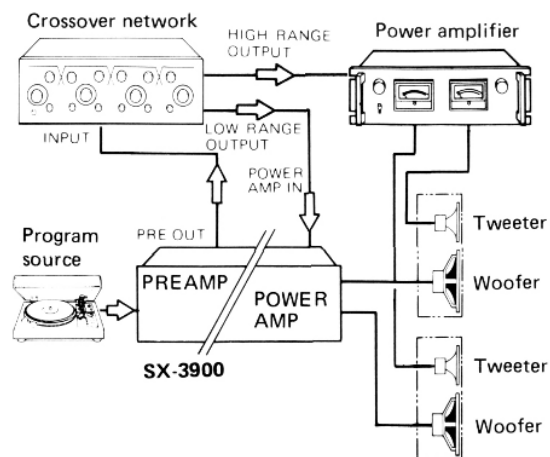

Fig. 21

SPECIFICATIONS

Power Amplifier Section

Continuous Power Output of 120 watts*per channel, min., at 8 ohms from 20Hertz to 20,000 Hertz with no more than 0.005% total harmonic distortion.

Total Harmonic Distortion (20 Hertz to 20,000 Hertz, 8 ohms)

continuous rated power output . . . No more than 0.005%
60 watts per channel power
output No more than 0.005%

Intermodulation Distortion (50 Hertz : 7,000 Hertz = 4 : 1)

continuous rated power output . . . No more than 0.005%
60 watts per channel power
output No more than 0.005%

Frequency Response

. 5 Hertz to 200,000 Hertz $\begin{matrix} +0 \\ -3 \end{matrix}$ dB

Input Sensitivity/Impedance (POWER AMP IN)

. 1V/50 kilohms

Output

Speaker A, B, A+B

Damping Factor (20 Hertz to 20,000 Hertz, 8 ohms)

. 60

Hum and Noise (IHF, short-circuited, A network)

. 115dB

Preamplifier Section

Input (Sensitivity/Impedance)

PHONO 1, 2. 2.5mV/50 kilohms

AUX, TAPE PLAY 1, 2,

ADAPTOR IN 150mV/50 kilohms

Phono Overload Level (T.H.D. 0.005%, 1,000 Hertz)

PHONO 1, 2. 300mV

Output (Level/Impedance)

TAPE REC 1, 2, ADAPTOR OUT

. 150mV

PREAMP OUT (R_L : 50 kilohms)

. 1V/1 kilohms (Volume: max.)

Total Harmonic Distortion (20 Hertz to 20,000 Hertz)

PHONO 1, 2 (REC OUT) No more than 0.005%
(10V output)

AUX, TAPE PLAY 1, 2, ADAPTOR IN

. No more than 0.005%
(10V output)

Frequency Response

PHONO (RIAA Equalization)

. 20 Hertz to 20,000 Hertz ± 0.2 dB

AUX, TAPE PLAY 1, 2, ADAPTOR OUT

. 7 Hertz to 80 000 Hertz $\begin{matrix} +0 \\ -1 \end{matrix}$ dB

Tone Control

BASS ± 4 dB/ ± 7 dB (100Hz)
Turnover Frequency: 200Hz/400Hz

TREBLE ± 9 dB/ ± 7 dB (10kHz)
Turnover Frequency: 2kHz/4kHz

Filter

LOW 15Hz (-6dB/oct.)

HIGH 8kHz (-6dB/oct.)

Loudness Contour (Volume control set at -40dB position)
. +6dB (100Hz), +3dB (10,000Hz)

Hum and Noise (IHF, short-circuited, A network)

PHONO 86dB

AUX, TAPE PLAY 1, 2,

ADAPTOR IN 105dB

Attenuator -20dB

FM Tuner Section

Usable Sensitivity (IHF) 9.8dBf (1.7 μ V)

50dB Quieting Sensitivity

MONO 14.2dBf (2.8 μ V)

STEREO 36dBf (34.7 μ V)

Signal-to-Noise Ratio

MONO 83dB (at 65dBf)

STEREO 78dB (at 80dBf)

Distortion (at 65dBf)

MONO 100Hz. 0.1%

1kHz 0.07%

6kHz 0.1%

STEREO 100Hz. 0.2%

1kHz 0.15%

6kHz 0.2%

Capture Ratio 1.0dB

Alternate Channel Selectivity

400kHz 80dB

Stereo Separation

1kHz 50dB

30Hz to 15kHz 35dB

Frequency Response

. 20Hz to 15kHz $\begin{matrix} +0.2 \\ -0.8 \end{matrix}$ dB

Spurious Response Ratio 100dB

Image Response Ratio 90dB

IF Response Ratio 100dB

AM Suppression Ratio 60dB

Subcarrier Product Ratio 64dB

SCA Rejection Ratio 64dB

Muting Threshold 19.2dBf (5 μ V)

Antenna Input 300 ohms balanced,
75 ohms unbalanced.

AM Tuner Section

Sensitivity (IHF, Ferrite antenna) . . .	300 μ V/m
(IHF, Ext. antenna) . . .	15 μ V
Selectivity	30dB
Signal-to-Noise Ratio	50dB
Image Response Ratio	40dB
IF Response Ratio	40dB
Antenna	Ferrite loopstick antenna

Audio Section

Output (Level/Impedance)	
FM (100% Mod.)	650mV/2.4 kilohms
AM (30% Mod.)	200mV/2.4 kilohms

Semiconductors

ICs	15
FETs	6
Transistors	89
Diodes	62

Miscellaneous

Power Requirements	AC 120V, 60Hz
Power Consumption	350W (UL)
Dimensions	526(W) x 176(H) x 452(D) mm 20-11/16(W) x 6-15/16 (H) x 17-14/16(D) in
Weight (without package)	20kg (44lb 2oz)

Furnished Parts

Operating instructions	1
FM T-type antenna	1

** Measured pursuant to the Federal Trade Commission's Trade Regulation rule on Power Output Claims for Amplifiers.*

NOTE:

Specifications and the design subject to possible modifications without notice due to improvements.

TROUBLESHOOTING

If your stereo appears to malfunction, first check such things as the controls (power switch, function switch, tape monitor switch, etc.) and connecting cords (components connected correctly).

Noise: There are a variety of noises relating of the operation of a hi-fi unit. There are generally divided into two types: (1) the unit is faulty (a transistor or part has deteriorated), and (2) an external source is interfering with the unit.

When a hi-fi unit produces an unpleasant noise, it is often assumed that the unit is faulty; however, statistical records indicate that the majority of noise produced in hi-fi acoustic units results from external sources of noise: Due to the inherent high-sensitivity and the high-fidelity reproduction, the unit amplifies and reproduces extraneous noise, however small, into audible output noise. If your receiver produces a noise, check according to the following table and trace the source of noise for the appropriate corrective action.

	Symptom	Suspected source of noise	Diagnosis and remedy
When listening to broadcasts	Continuous or intermittent buzzing noise.	<ul style="list-style-type: none"> • Static (lighting) • A fluorescent lamp, motor, or thermostat may be in use in the house or in the vicinity. 	In many cases, it is very difficult to remove the source of noise. In order to make the radio input larger than the noise level, set up a good outdoor antenna and make a complete grounding.
	When a station is tuned in hum is mixed in the program.	<ul style="list-style-type: none"> • A poor fluorescent lamp, motor, or electric heater may be in use in the house or nearby. 	Reversing the power plug may occasionally alleviate this noise problem. Usually it is very difficult to eliminate the noise.
	Hissing noise an AM (medium wave) reception.	<ul style="list-style-type: none"> • The frequency of an adjacent station is interfering with that of the station being tuned in to (10kHz beat interference). • TV set is on in the same house with the receiver. 	Impossible to remove such interference. If the cause of such noise is the TV set, increase the distance between the TV set and receiver.
	Static noise (in particular, when automobiles run close to the house).	<ul style="list-style-type: none"> • White noise generated from automobile engines. • High-frequency sewing machine or welding machine being used near your house. 	In an area surrounded by hills or high buildings, the FM input signals are very weak. Thus the noise limiter in the circuit loses its function. Set up an FM outdoor antenna having many director elements.
	Reception of FM stereo program contains more noise than FM mono program.	<ul style="list-style-type: none"> • Note that the service area covered by an FM stereo broadcast is about 50% of that of a regular mono broadcast. 	Increasing the FM input signal may alleviate this problem. Use an exclusive FM outdoor antenna instead of the indoor T-type antenna.
When playing records	Hum or buzz. When switched to radio reception, the noise disappears.	<ul style="list-style-type: none"> • Poor connection shielded wire. (a) • Jack connection is loose. (b) • Power lead of fluorescent lamp passes near the shielded wire. (c) • Poor grounding. (d) • Ham transmitting station or TV transmitting station is near your house. (e) 	Correct the conditions stated in (a), (b), (c), or (d). In case of (e), report it to an official authority.
	Output tone quality is poor and mixed with noise. Treble is not clear.	<ul style="list-style-type: none"> • Stylus is worn. (a) • Record is worn. (b) • Dust adhering to stylus. (c) • Stylus is improperly mounted. (d) • Stylus pressure (tracking force) is not correct. (e) • The treble level is too high. 	Check (a) through (e) and correct the condition. Turn the treble control to OFF.
	In playing a record, increasing the volume causes howling.	<ul style="list-style-type: none"> • Distance between the turntable and the speakers is too short. • The turntable or speakers supports are unstable. 	Increase the distance or rearrange the installation of the unit and speakers. (Installing the turntable on a firm, solid stand may alleviate this problem.) Do not enhance the bass sound level excessively.

Protection Circuit

After the power switch is set to ON, there is delay of about 5 seconds before sound is obtained. This is due to the muting function of the protection circuit which eliminates unpleasant noise when the power supply is activated.

PIONEER ELECTRONIC CORPORATION 4-1, Meguro 1-Chome, Meguro-ku, Tokyo 153, Japan
U.S. PIONEER ELECTRONICS CORPORATION 85 Oxford Drive, Moonachie, New Jersey 07074, U.S.A.
PIONEER ELECTRONIC (EUROPE) N.V. Luithagen-Haven 9, 2030 Antwerp, Belgium
PIONEER ELECTRONICS AUSTRALIA PTY. LTD. 178-184 Boundary Road, Braeside, Victoria 3195, Australia