

OWNER'S MANUAL

PLEASE READ BEFORE OPERATING THIS EQUIPMENT.

WIDE RANGE STEREO FREQUENCY EQUALIZER

CATALOG NO. 31-2000A

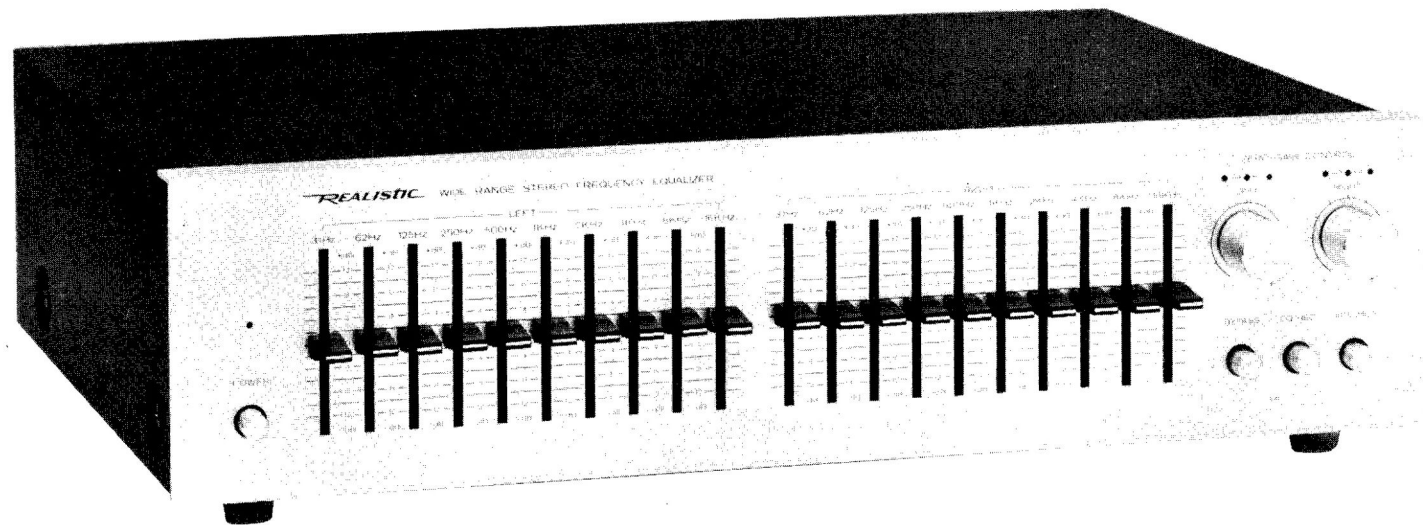

CUSTOM MANUFACTURED FOR RADIO SHACK, A DIVISION OF TANDY CORPORATION

REALISTIC[®]

REALISTIC®

THE BRAND WITH OVER 10,000,000 CUSTOMERS

For your own protection, we urge you to record the Serial Number of this unit in the space provided. You'll find the Serial Number on the back panel of the unit.

Serial Number

RADIO SHACK LIMITED WARRANTY

This product is warranted against defects for 2 years from date of purchase from Radio Shack company-owned stores and authorized Radio Shack franchisees and dealers. Within this period, we will repair it without charge for parts and labor. Simply **bring your Radio Shack sales slip** as proof of purchase date to any Radio Shack store. Warranty does not cover transportation costs. Nor does it cover a product subjected to misuse or accidental damage.

EXCEPT AS PROVIDED HEREIN, RADIO SHACK MAKES NO WARRANTIES, EXPRESS OR IMPLIED, INCLUDING WARRANTIES OF MERCHANTABILITY AND FITNESS FOR A PARTICULAR PURPOSE. Some states do not permit limitation or exclusion of implied warranties; therefore, the aforesaid limitation(s) or exclusion(s) may not apply to the purchaser.

This warranty gives you specific legal rights and you may also have other rights which vary from state to state.

We Service What We Sell



Speakers



Components

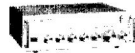

P.A. Products

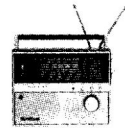

Radios



Recorders



Phonographs

REALISTIC AUDIO PRODUCTS are the proud result of Radio Shack engineering, research, development, and over 50 years of experience in electronics. Laboratories are maintained in Boston, Ft. Worth, Los Angeles, and abroad. In every sense a national brand, the Realistic label is worn with equal distinction by our highly original Communications and Citizens Band (two-way radio) products, and numerous other items, including tape, headphones, antennas, intercoms and tubes.

In choosing this fine Realistic product you have demonstrated a rather acute awareness of the good old American custom called "getting the most for your money". With Realistic this is not an idle boast.

The "line" was born in Boston, long famous for Yankee ingenuity — and thrift. Its original intent was to bridge a gap between \$100 equipment and \$25 equipment where, at the time, there was a real void in hi-fi merchandise.

Early products were a \$39.95 FM tuner, a \$29.95 preamp/amplifier, a \$19.95 speaker. Soon we found ourselves a unique niche as manufacturing retailers.

Capacity and ability grew simultaneously. Soon Realistic hi-fi products — loudspeakers, receivers, tape decks, even table radios — began receiving critical acclaim for faultless performance as well as value. Dealers and franchises from all over the world began requesting a Realistic franchise.

Today you can shop The Worldwide Supermarket of Sound® with the confidence that you're getting the widest selection of quality hi-fi equipment available anywhere — whether you're looking at budget-priced extension speakers or true audio-ophile receivers.

SPECIFICATIONS

The **REALISTIC Wide Range Stereo Frequency Equalizer** is designed to tailor the frequency response of your stereo system. Since it has separate controls for each channel, it gives you an almost infinite combination of control variations. The controls each have a range of approximately 24 dB (± 12 dB) and are calibrated in 4 dB increments.

There are many reasons why you need such a specialized component. The speakers, the room, your ears and your personal preferences vary greatly. For example, if a speaker is simply moved 6 to 8" (15 to 20 cm) away from the wall, the bass response at 50 Hz could drop as much as 8 to 10 dB.

The furnishings in the room, such as stuffed chairs, draperies and floor covering can affect the high and middle frequency response very dramatically.

It is a known fact that our hearing changes with age and varies greatly from person to person and when the sound pressure or volume is decreased. The ear's low frequency response at conversational levels, can be as much as 15 dB lower than at live concert levels at normal conversational levels.

Normal Dual Tone Controls vary too much of the audio spectrum. If we want to increase the low bass, we also increase the middle bass which very often muddies up the whole bottom end. The same is true with the treble control. We cannot boost or cut the midrange without affecting the entire high frequency response.

The Frequency Equalizer with its ten frequency bands can give almost an infinite number of possible frequency response variations. It will allow you to match your speakers to your room and the music to your ears — without adding distortion, hum or hiss.

The Equalizer can also be used when making recordings of old LP's or 78's without losing the main portion of the music. It can get rid of the scratchy top, add a little needed bass . . . and really bring some of those old 78's alive again.

Zero Gain Controls with LED indicators simplify channel balancing and level setting of the equalized signal to virtually the same level as the input signal, giving unity gain.

The circuit of the Equalizer is new type of tone control circuit which yields extremely low distortion. The components used are of the highest quality. We wish you many years of good sound!

Number of Channels	: Two (Left & Right), with separate controls for each
Frequency Response (flat setting)	: 5 to 50,000 Hz $^{+0.5}_{-1.0}$ dB
Tone Control Range	: ± 12 dB @31, 62, 125, 250, 500, 1,000, 2,000, 4,000, 8,000 and 16,000 Hz
Intermodulation Distortion	: 0.02% @0.775 volts output
Harmonic Distortion	: 0.02% @0.775 volts output (20–20,000 Hz)
Hum and Noise (shorted input)	: 80 dB (0.775 volts input)
Dynamic Range (flat setting)	: Up to 10 volts RMS
Total Gain (flat setting)	: 0 dB
Input Impedance	: 60 K ohms
Output Impedance	: 100 ohms (provides suitable match for circuits with impedance of 5 K ohms to 1 M ohms)
Inputs	: INPUT, TAPE MONitor
Outputs	: OUTPUT, TAPE OUT
Controls	: Power Switch (indicated with L.E.D.) 20 Linear Sliding Frequency Controls (10 each channel), Tape Monitor Switch, EQ REC Switch, BYPASS Switch, Zero Gain Controls
Power Requirements	: 120 volt AC, 60 Hz, 15 watts for UL & C.S.A. models (220/240 volt AC, 50 Hz, 15 watts for European and 240 volt AC, 50 Hz, 15 watts for Australian models)

CONTROL LOCATIONS AND FUNCTION

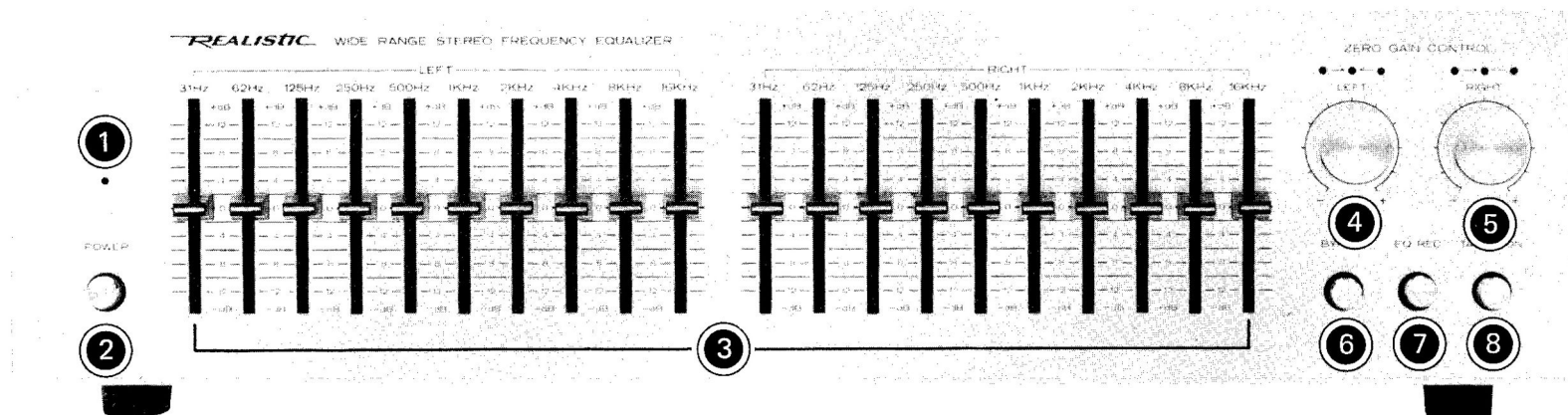

① Power Indicator LED

Lights up when power is "on".

② POWER

Push in to turn "on", the LED will light. Press again to turn "off".

③ Frequency Slide Controls

Control the frequency response. Permit a Boost or Cut upto 12 dB at the frequencies shown above each control.

④ ZERO GAIN CONTROLs (LEFT and RIGHT)

To restore the output level from the Equalizer to the original input level. Three LED's above each control are indicators for setting the levels.

⑤ Right and left red LED's show the output level is improper. Adjust the ZERO GAIN CONTROL toward + or - so the center LED glows green.

⑥ BYPASS Button

Press to bypass the Equalizer circuit.

⑦ EQualization RECOrd Button

Press into record the "Equalized" sound. Otherwise leave in the "out" position.

⑧ TAPE MONitor Button

Pressed to listen to the output from the Tape Deck. Use this to hear recordings as they are being made on your 3-head Tape Deck or when playing back tapes.

Rear Panel

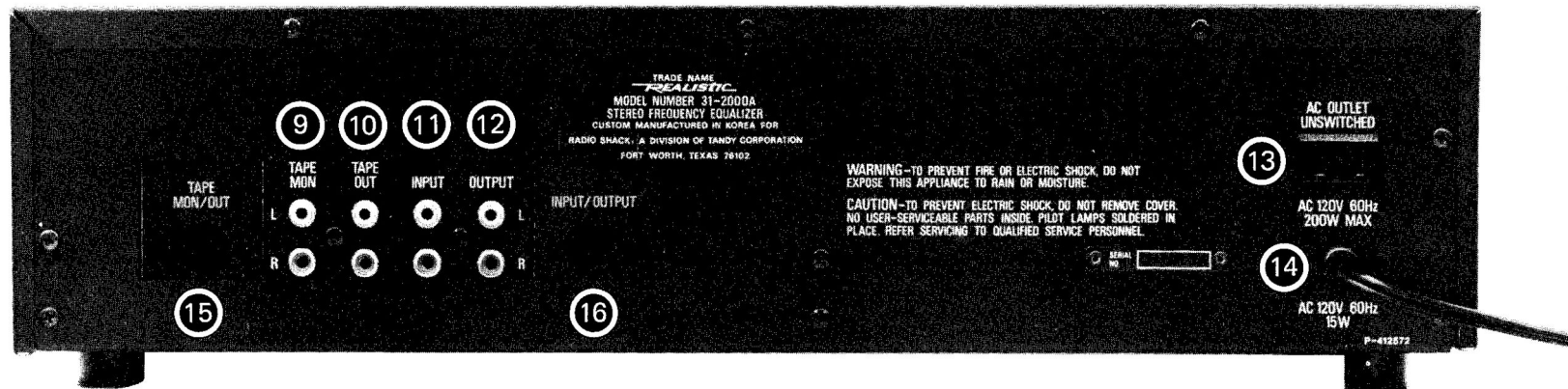

- 9 TAPE MONitor Jack**
Connect to Tape Deck's Output jacks for tape playback (or record monitor with 3-head deck).
To activate these jacks, press in TAPE MONitor button.
- 10 TAPE OUT Jack**
Connect to Tape Deck's Auxiliary Input for recording.
- 11 INPUT Jack**
Connect to "Tape Out" or "Pre Out" of your Amplifier/Receiver.
- 12 OUTPUT Jack**
Connect to the "Tape In" or "Main In" jacks of your Amplifier/Receiver.
- 13 UNSWITCHED AC Convenience OUTLET**
Powers any audio accessory up to 200 watt. The Front Panel POWER does not affect this receptacle. (Not available for UK models)

- 14 AC Cord**
Connect into any 120 V AC, 60 Hz outlet (220/240 V AC, 50 Hz for European and 240 V AC, 50 Hz for Australian models as indicated on rear of unit).

- EUROPEAN/AUSTRALIAN models only-----
- 15 TAPE MON/OUT DIN Jack**
To connect to Tape Deck which has DIN connector. Use RCA type or DIN Jack, not both.
- 16 INPUT/OUTPUT DIN Jack**
To connect to Amplifier/Receiver which has DIN connector. Use RCA type or DIN Jack, not both.

CONNECTIONS

With an Amplifier/Receiver Incorporating a Tape Monitor Switch

With an integrated Amplifier/Receiver which has a Tape Monitor Switch, make connections as shown in Figure 1A. Set the Amplifier/Receiver's Tape Monitor switch to the IN or MONITOR position. To disconnect the Equalizer, set the Amplifier/Receiver's Monitor switch to the OUT position.

NOTE: With this connection, the Tape Monitor switch on the Amplifier/Receiver will not be performing its original function (to "monitor" tape recordings). Thus, we've added a Monitor function to the Equalizer (with switch and jacks).

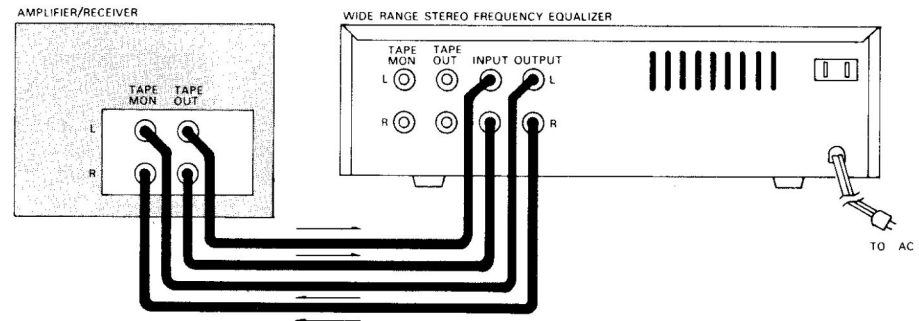

Figure 1A

With an Amplifier/Receiver Incorporating "PRE OUT" and "MAIN IN" Jacks or with Separate Preamp and Basic Amplifier.

If your audio system has a Pre-amplifier separate from the Power Amplifier, connect the Frequency Equalizer between the two, observing the correct channel notations. The Equalizer TAPE MONitor switch must be in the "out" position (button extended). Make connections as shown in Figure 1B.

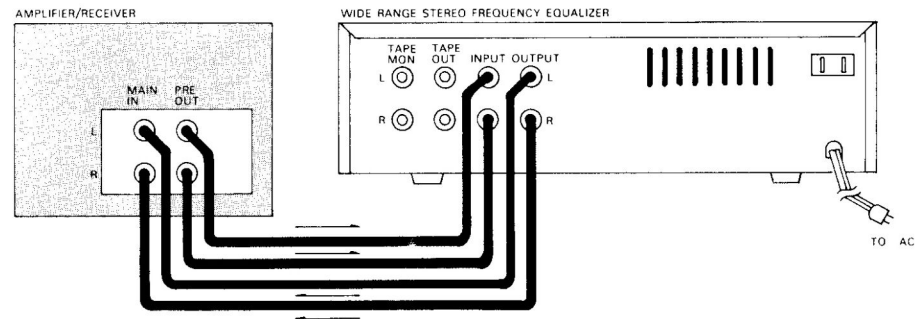

Figure 1B

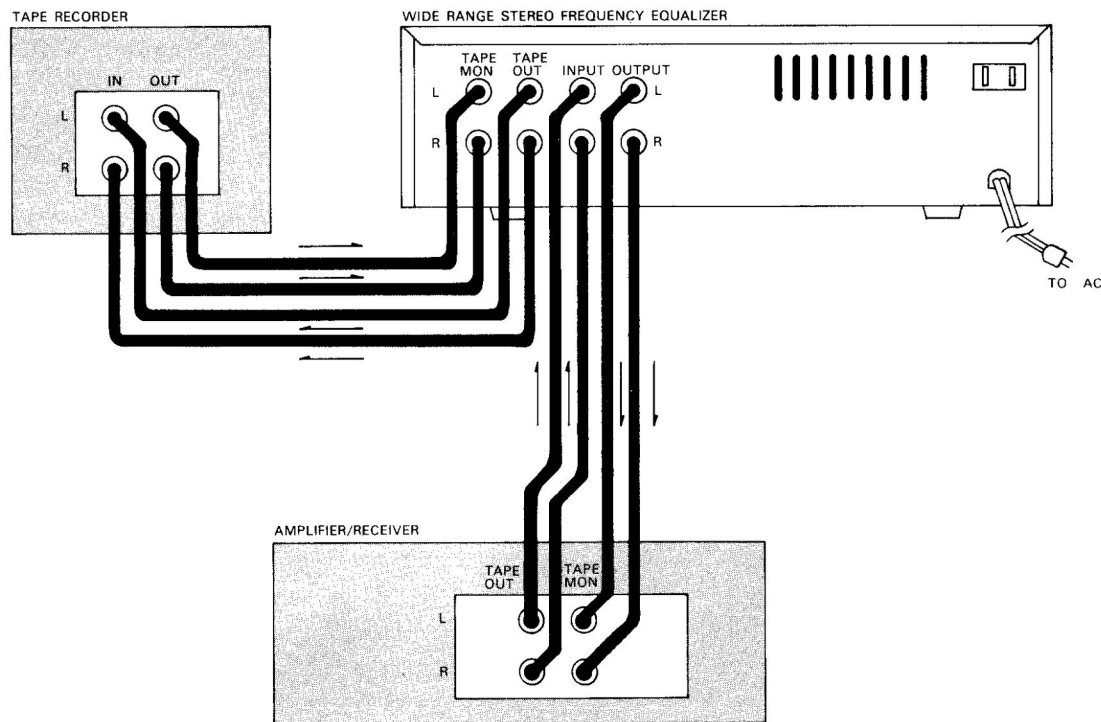

Figure 2

To incorporate the Tape Monitor feature with wiring as shown in Figure 1B, change connections to be as shown in Figure 2. If your Tape Recorder has monitor function (a 3-head deck), press the Equalizer's **MONITOR** button to hear the recording after it has been made (also, for normal Playback of tape from your Recorder).

For Monitoring, both the Amplifier/Receiver's Monitor and the Equalizer's **MONITOR** switch must be "in". If you don't need "monitoring", the Equalizer's **MONITOR** switch can be set to either position. If you want to process the "source" signal through the Equalizer, leave Amplifier/Receiver's Monitor switch "in".

IMPORTANT NOTE: When you are using connections as illustrated in Figure 2, when you "monitor" the recording, it will have been processed by the Equalizer — and thus will not be an accurate "monitor" signal. For accurate monitoring under these conditions, use the **BYPASS** button.

OPERATION

IMPORTANT — Wait 8–10 seconds after “Turn-On” for the Equalizer circuits to stabilize before operating the function switches. This will eliminate “popping” noises when function switches are actuated. Be sure to set the Volume control on your Receiver/Amplifier to minimum.

EQualization RECORD Button

When pressed in, the program source can be equalized before it goes to the Tape Recorder input. Use this function when recording from a poor quality program source (old records, etc.). In the “out” position (button extended), the program source signal to the Tape Recorder will not be equalized, while the signal to the Amplifier/Receiver can be equalized.

The simple illustrations below show the functions:

You can equalize your program material. But, Recording can not be equalized.

Button Positions

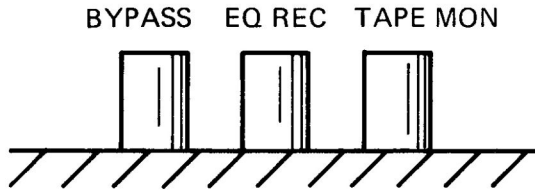

Program material AND Recording are processed through the Equalizer circuits.

Button Positions

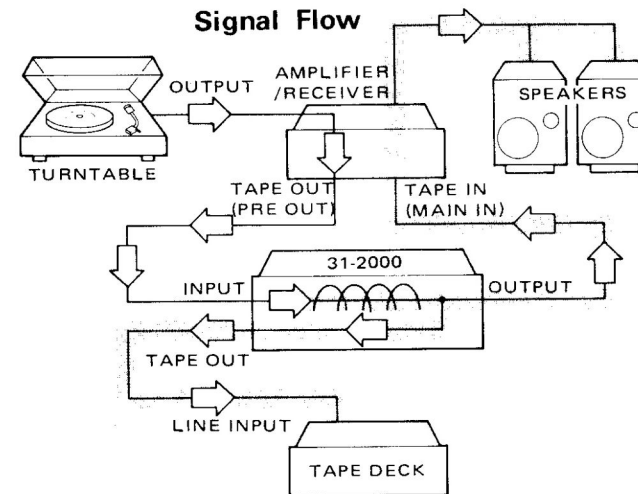
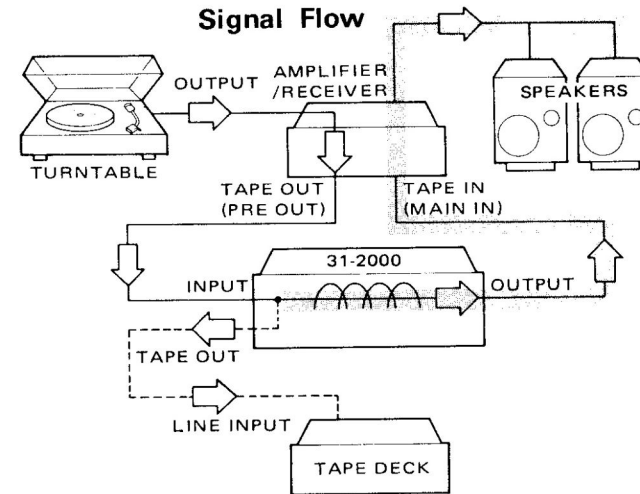
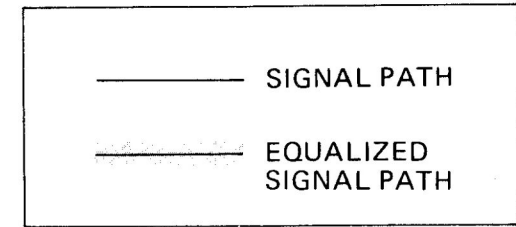
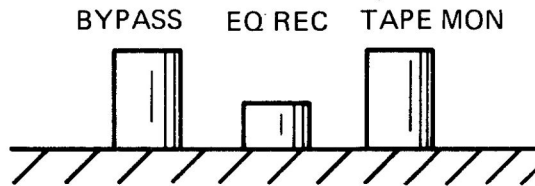

TAPE MONitor Button

When pressed, the output from the Tape Deck can be equalized and then heard through your speakers. Use this function to hear recordings as they are being made on your 3-head Tape Deck and when playing back tapes.

You can equalize tape playback, and the sound you hear from your Receiver will be as processed by the Equalizer.

Button Positions

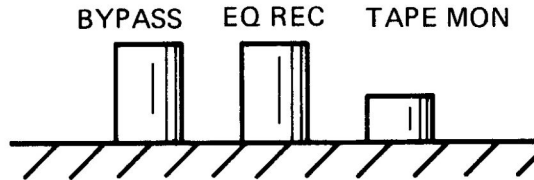

Signal Flow

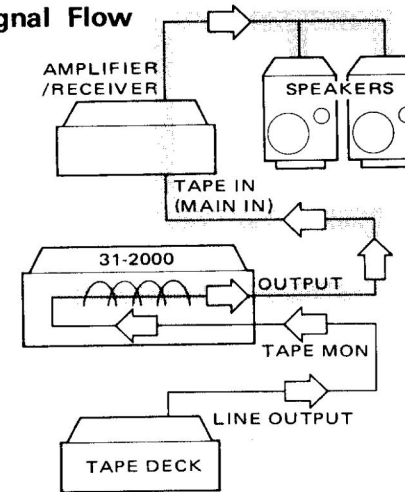

BYPASS Button

When you press BYPASS button, the Equalizer is completely disconnected from the system. TAPE MON button will still function when pressed in. But, as long as BYPASS is pressed, the Equalizer is not in the signal path (it is bypassed, out of the circuit).

You can not equalize any signal. TAPE MON will still function.

Button Positions

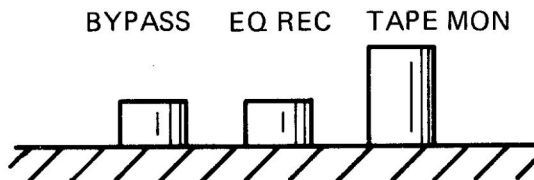
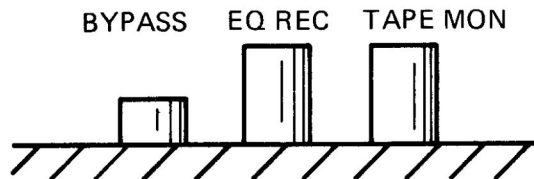

The Equalizer is bypassed, so position of EQ REC button is irrelevant.

Signal Flow

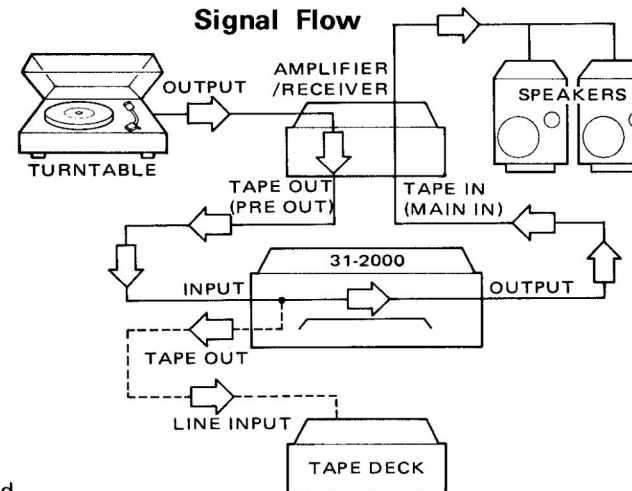

EQ REC and TAPE MON Buttons Pressed In

If you have a 3-head deck connected, the sound you hear from your Receiver will be actual recorded result. Adjust the Frequency Controls so the sound you hear compensates for deficiencies in the program source (such as eliminating hiss from old 78's). Do not adjust Frequency Controls to compensate for overall system deficiencies or room acoustics.

You are equalizing the recording being made.

Button Positions

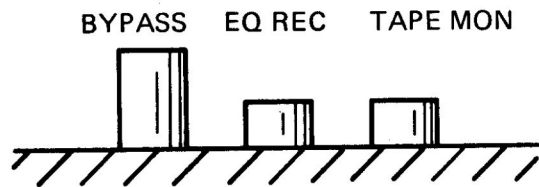

All Buttons Pressed In

The Equalizer is bypassed and the sound you hear will be what is coming from the Tape Recorder (tape playback or monitored signal from a 3-head deck).

You will hear output only from the Tape Recorder (no equalizing action).

Button Positions

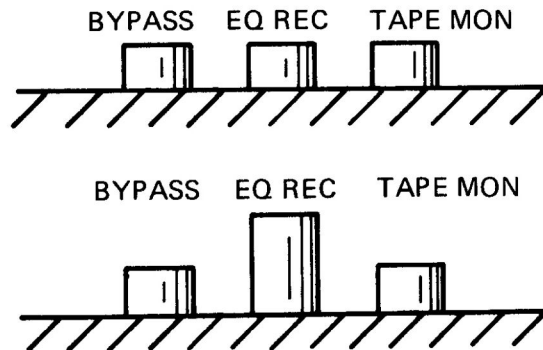

The Equalizer is bypassed, so position of EQ REC button is irrelevant.

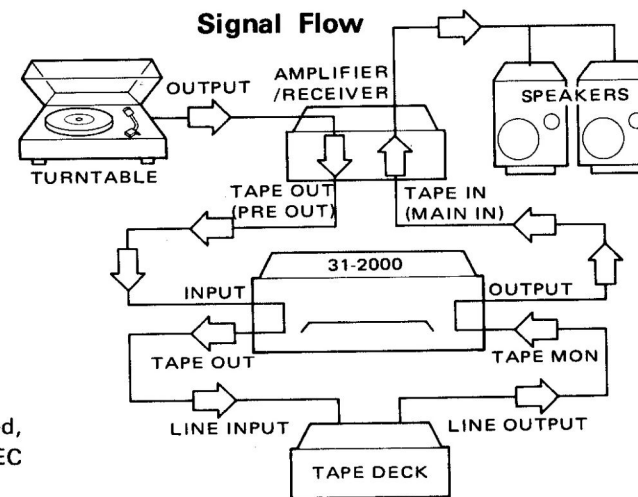
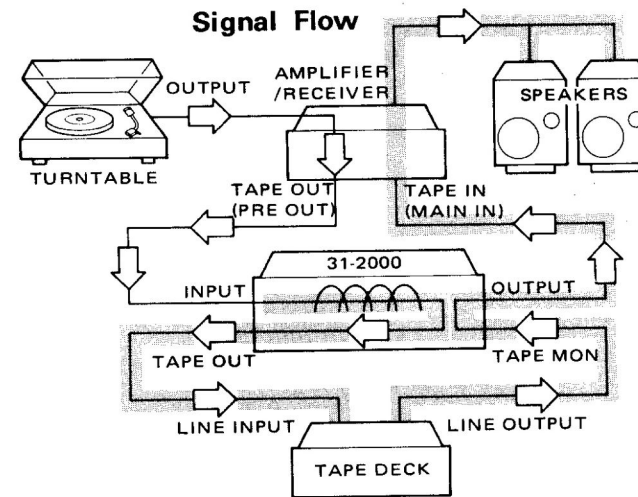

FREQUENCY SLIDE CONTROLS

TYPICAL FREQUENCY RESPONSE CURVES

The front panel has 20 controls, 10 per channel. Each control varies by ± 12 dB the level of a small range of audio frequencies which are centered around the frequency marked over each control. In order to achieve a smooth response, controls for adjacent frequencies within each band must interact. For example, the 500 Hz left channel control will affect the 1 kHz (1000 Hz) left channel control's effect. The net effect of such controls set in the same direction (both in boost or cut position) will be greater than the panel marking indicates. The effect of such controls set in opposite directions (one in boost and one in cut) will be less than indicated. Refer to Figure 3 through 7 for typical slide control effect.

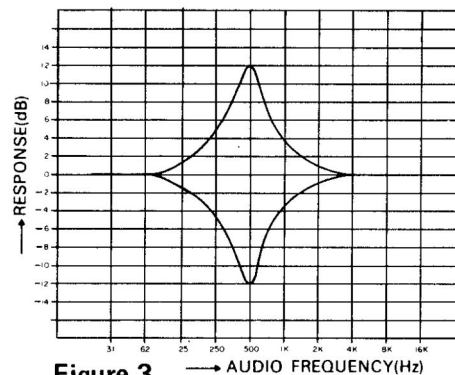

Figure 3

500 Hz : Full Boost
500 Hz : Full Cut

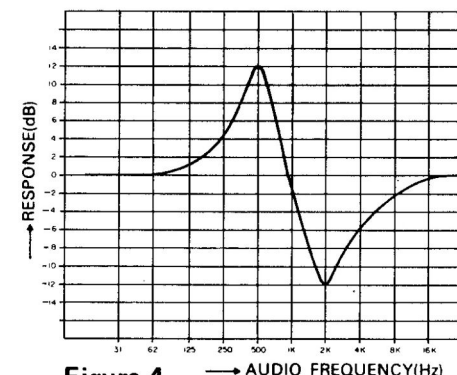

Figure 4

500 Hz : Full Boost
2 kHz : Full Cut

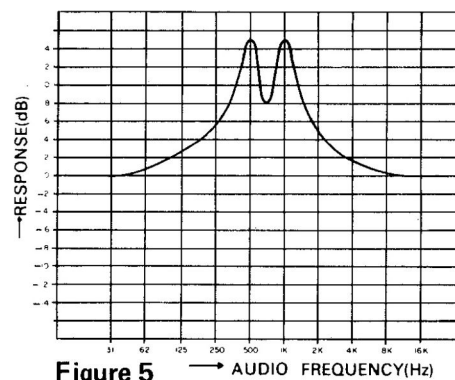

Figure 5

500 Hz : Full Boost
1 kHz : Full Boost

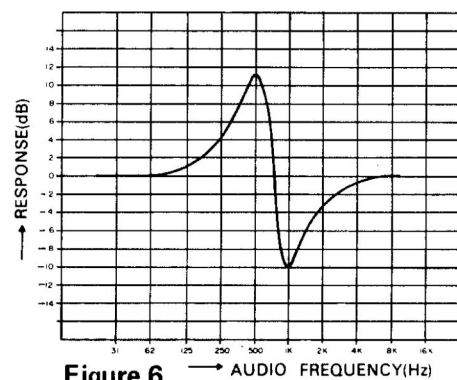

Figure 6

500 Hz : Full Boost
1 kHz : Full Cut

ZERO GAIN CONTROLS

NOTES:

1. Set the Amplifier/Receiver's tone controls to their "flat" position (or use "Tone Flat" switch if you have such a switch).
2. Depending on the location of the Equalizer, you may notice some hum pickup (this would be from magnetic lines of flux from nearby power transformers). If this happens, try re-positioning the Equalizer — as far away as possible from such sources of magnetism.

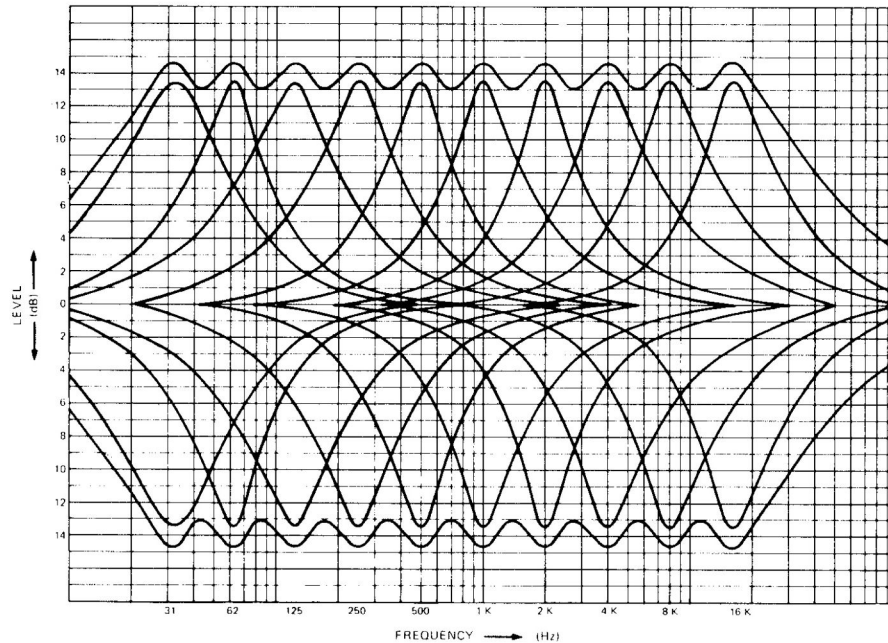

Figure 7

The Slide Frequency Controls will change the average level of the program material (signal) as they are moved up or down from the "0" dB (flat) position. After having equalized your system, the average signal level to each channel of your Amplifier/Receiver may be higher or lower than that of the original input signal to the Equalizer (i.e. the level which your Amplifier/Receiver would receive if you didn't use the Equalizer).

To restore the output level from the Equalizer to the original input level, the ZERO GAIN CONTROLS must be adjusted. There are three LED's above each control as indicators for setting the levels. These will insure that you don't over-drive your Amplifier/Receiver or Speakers (which can result in distortion) and will make sure that the signal levels of left and right channels are same.

After equalization, the LED indicators will light red. Adjust the ZERO GAIN CONTROL toward + or - so the center LED glows green. At this position, the average signal level of equalized signal will be same as the original level (Unity Gain).

NOTE: When adjusting ZERO GAIN CONTROLS you will find that the red and green LED's flicker with variation in the program signal. Ideal setting of the ZERO GAIN CONTROLS will be when only the green LED's flicker (or midway between the points where the upper and lower red LED's flicker). Only when the red LED's stay on all the time it is necessary to adjust the ZERO GAIN CONTROL(s).

If you connect your Equalizer using the PRE OUT/MAIN IN jacks, you might notice the LEDs on your Equalizer will not light except at loud volume levels. This is normal: your Equalizer is still functioning normally.

THE MUSICAL SPECTRUM

This chart correlates familiar musical instruments with the numerical frequencies that they produce. Given the often talked about musical range of 20 to 20,000 Hz, it is surprising to see how low musical fundamentals actually are. (Almost all are under 3,500 Hz.) It should be understood however that if all instruments were perceived only by their fundamental frequency output (black areas), they would all sound alike. It is the harmonics or overtones (shaded areas) that give each individual instrument its character or timbre and set it apart from the rest.

Interestingly enough, the human ear is more sensitive to certain octaves in the musical spectrum than to others. Whoever designed this engineering marvel deemed it necessary to tune the ear more toward the midrange frequencies, where speech and voice communication occur, than to the outer octaves of low bass and high musical overtones. As a result, very small energy changes in the middle frequencies will cause a more drastic psychoacoustic effect than larger changes would at the frequency extremes.

In order to discuss the qualitative effects of adjustment in tonal balance, it is best to arbitrarily divide the musical spectrum into five ranges:

The Bass (approximately 20–140 Hz). There is little musical material with fundamental frequencies below about 60 Hz, and what is normally perceived as low bass material is actually in the 60–140 Hz range. The two lowest frequency controls can be used to enhance output for the few instruments in that range (organ, contrabassoon, etc.) or can be used to reduce rumble, acoustic feedback and other low frequency aberrations. The 31 Hz, 62 Hz and 125 Hz controls will cause the greatest perceptible changes in "bass response".

The Mid-Bass (approximately 140–400 Hz). An over-accentuated mid-bass region will yield a very muddy and "boomy" quality to the music. A system shy of mid-bass will sound hollow and thin. The 250 Hz control is important for good overall balance.

Approximate Frequency Ranges for Musical Instruments and Voice

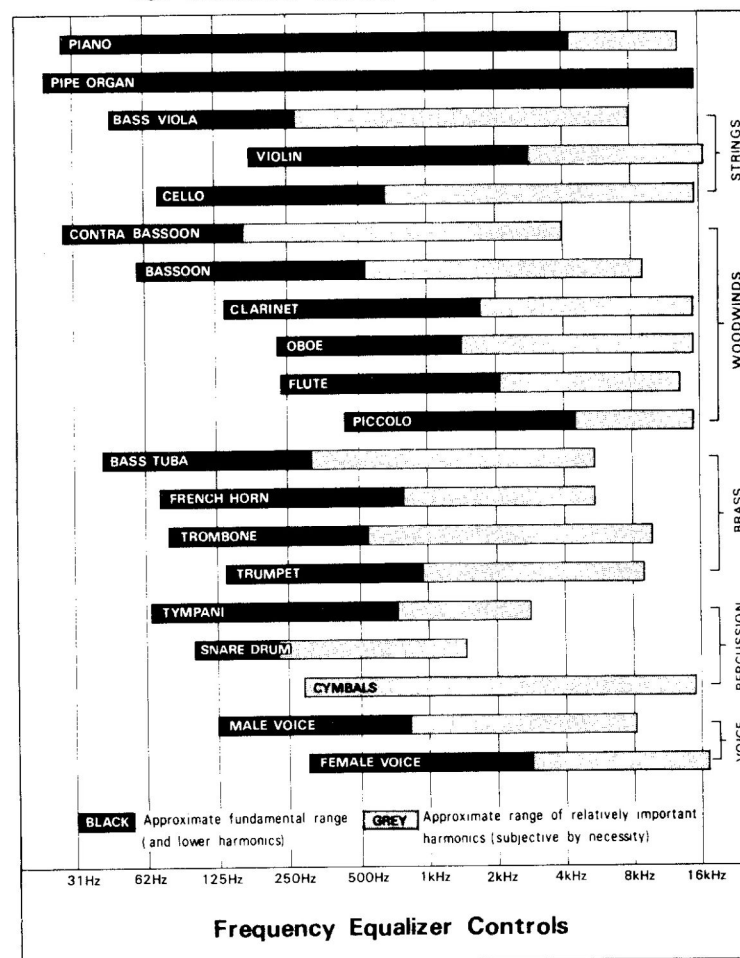

Figure 8

CAUTION

The Mid-Range (approximately 400–2600 Hz). As the area where the ear is most sensitive to tonal balance, the mid-range is important in adjusting the qualitative sonic characteristics of your system. There is controversy among engineers and audiophiles as to what the proper balance should be in this range. Moreover, you will find some 500 Hz, 1 kHz or 2 kHz control settings optimum for certain types of music, with other settings just right for different types.

The Upper Mid-Range (approximately 2600–5200 Hz). Speaker designers often boost output in this range to give a quality of "presence" to the music. Too much energy, on the other hand, sounds overbearingly harsh and strident. A good balance should be achieved between this and a more muffled sound. Use the 4 kHz control for this effect.

The High End (approximately 5200–20,000 Hz). The region up to only about 12,000 Hz or so is what is normally perceived as high frequencies. Adjustment of the 8 kHz control affects the brilliance of music, with too much boost in energy yielding an unpleasant and piercing quality.

The last 8000 Hz contains very little musical material. And most adults have hearing which rolls off rapidly above 13,000 to 15,000 Hz. As a consequence, the 16 kHz control will have a very subtle effect. It can be used to add a little more dimension to the sound, or as a very high frequency noise filter.

Note for European and Australian Models

European and Australian models are equipped with both DIN Sockets and Phono Sockets.

Depending on your Amplifier/Receiver you may use either the DIN type or the Phono type but never try to use both at the same time. If you connect a Tape Recorder to the Equalizer you must use the same type connections as used to connect the Equalizer to the Amplifier/Receiver. If the Equalizer-to-Amplifier/Receiver connection is DIN, the Tape Recorder-to-Equalizer connection must be DIN also (or both connections must be Phono-type only).

If your sound system employs separate components, e.g. Preamplifier and Amplifier, and the Equalizer is connected between the output of the preamplifier and input of your power amplifier, it is important to follow the procedures below:

1. Power "on" Sequence
 - A. Turn on the Equalizer.
 - B. Turn on your Preamplifier.
 - C. Turn on your Power Amplifier.

Follow the reverse sequence in turning your system "off".

2. You must reduce Volume control setting **before** switching the Equalizer **IN** or **OUT** of the Sound System. Failure to do this will result in excessive volume when the Equalizer is introduced into the system and can result in damage to your Amplifier or Speakers.

All Equalizers are designed for unity gain; in other words, the level of signal "OUT" is the same as the level "IN" **WHEN ALL FREQUENCY CONTROLS ARE SET AT "0"**.

If one or several frequency controls are boosted in either or both channels (stereo), the output level from your Equalizer will increase within the range of frequencies affected by those controls, thereby increasing the sound level or power output of your Amplifier. Depending on your master Volume control setting, this can result in overdriving of your Power Amplifier and/or Speaker system and incurring possible damage.

Thus we suggest you reduce the master Volume control setting of your sound system before switching the Equalizer in or out of the system and then restore the master Volume control setting for your listening pleasure.

SCHEMATIC DIAGRAM

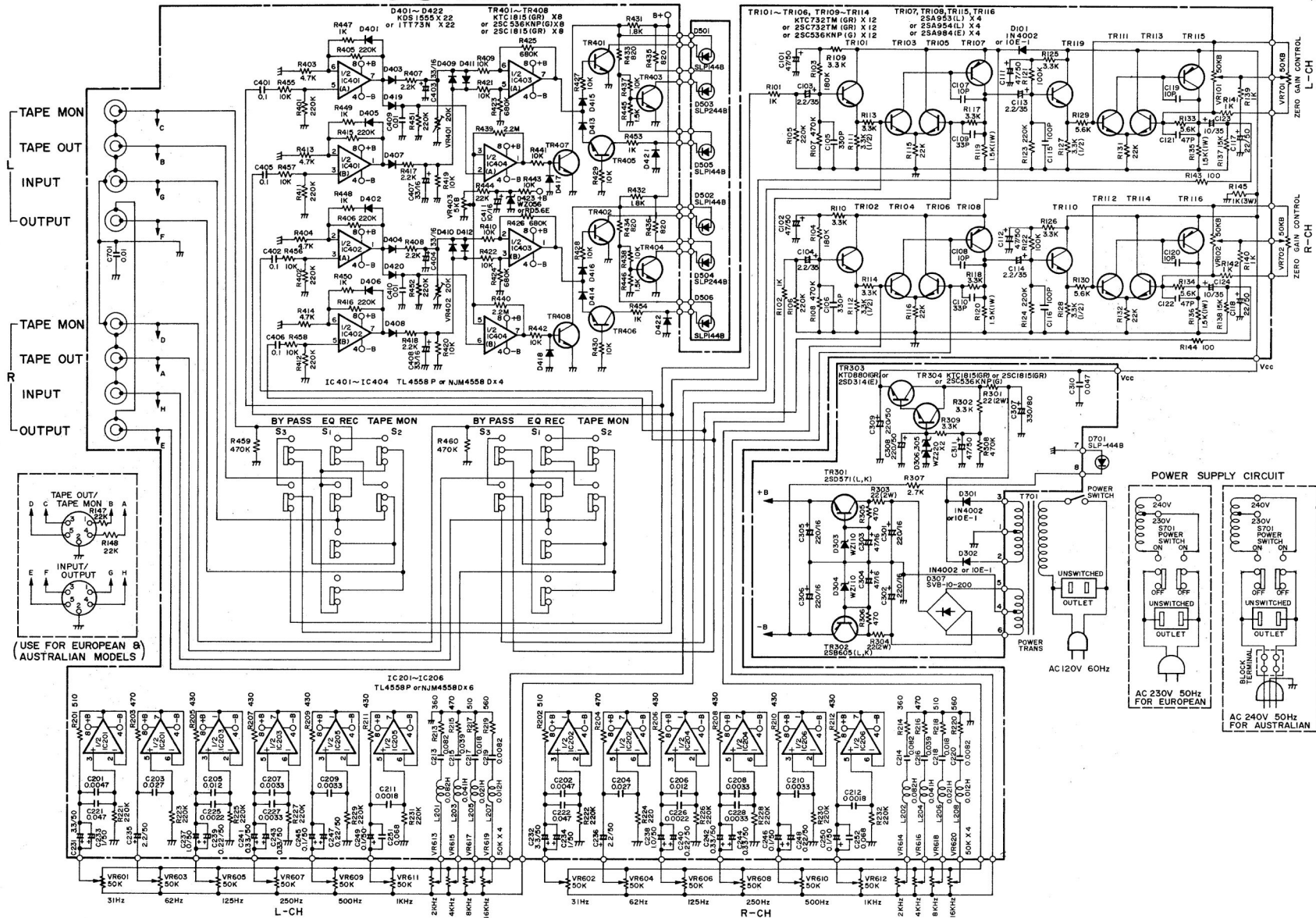

Schematic subject to change without notice. For most accurate Schematic (and parts) contact Radio Shack, National Parts Dept., Fort Worth, TX 76101.
 In UK, contact Tandy Electronics, National Parts Dept., Bilston Road, Wednesbury, West Midlands WS10 7JN.
 In Australia, contact Tandy Corporation (Australian Branch), National Parts Dept., 280-316 Victoria Road, Rydalmere, NSW 2116.

NOTE: (1) ALL RESISTANCE VALUES ARE INDICATED IN "OHM" (K = 10^3 OHM, M = 10^6 OHM).
 (2) ALL CAPACITANCE VALUES ARE INDICATED IN "μF" (P = 10^{-6} μF).

REALISTIC SPEAKERS— WE'RE IN IT FOR THE MUSIC

From our awesome Optimus T-200 Tower Speaker to our amazing Minimus-7, we've designed and engineered Realistic Speaker systems with one goal in mind — The Sound of Music. You'll discover the deep, rich bass and crisp, clean highs from all the music you enjoy.

And the contemporary styling of Realistic Speakers means your speaker system will look as good as it sounds.

Your local Radio Shack has the complete line of Realistic Speakers. Stop in and take a listen soon.

MACH™ SERIES



Mach One

MINIMUS-7

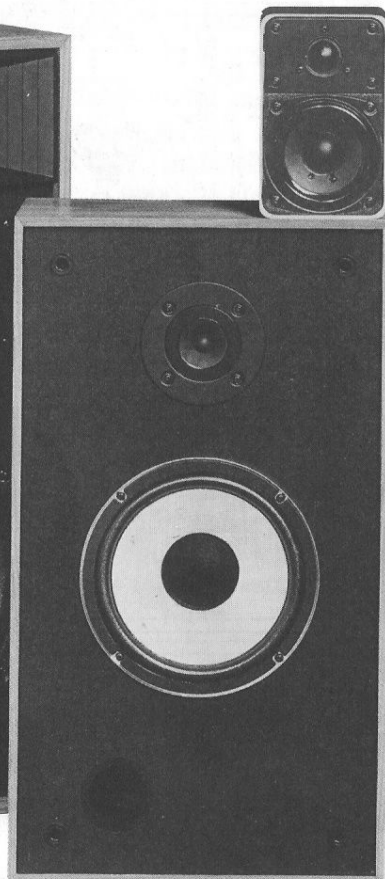

MC-2001

MINIMUS® SERIES

MINIMUS-11



NOVA® -10

OPTIMUS® SERIES



T-200

REALISTIC®

AUSTRALIA

280-316 VICTORIA ROAD
RYDALMERE, N.S.W. 2116

BELGIUM

PARC INDUSTRIEL DE NANINNE
5140 NANINNE

U. K.

BILSTON ROAD, WEDNESBURY
WEST MIDLANDS WS10 7JN

RADIO SHACK, A DIVISION OF TANDY CORPORATION: U.S.A.: FORT WORTH, TEXAS 76102: CANADA: BARRIE, ONTARIO L4M 4W5