

ALIGNMENT INSTRUCTIONS

AUDIO CIRCUIT ADJUSTMENT/CHECK

EQUIPMENT REQUIRED

1. DC Voltmeter
2. Audio Oscillator
3. Oscilloscope
4. AC Voltmeter

- Note
- * Maintain voltage at 120 volts, AC 60 Hz.
 - * Set SELECTORS Switch to AUX 1.
 - * Set MODE Switch to STEREO.
 - * See P.C.B. illustration for alignment points/adjustments.

For location of connection points and trimmer resistors, see P.C.B. view.

MAIN AMP ADJUSTMENT

STEP	ADJUSTMENT	EQUIPMENT	CONNECTION	AUDIO FREQ.	LEVEL	ADJUSTMENT
1	Check Balance by measuring DC voltage across OUTPUT TERMINAL of L and R channel.	DC Volt Meter	See Fig. 1.	No signal	DC voltage should be less than 20 mV.	VR 501 VR 502
2	Idling current adjustment	DC Volt Meter	See Fig. 2.	No signal	Adjust voltage across Emitter resistors R 557 and R 558 to 17.5 mV (8 ohm Load).	VR 503 VR 504

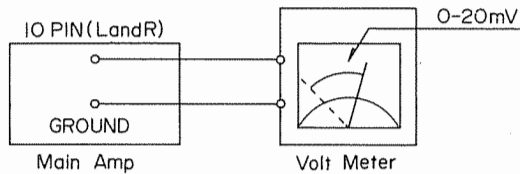

Figure 1

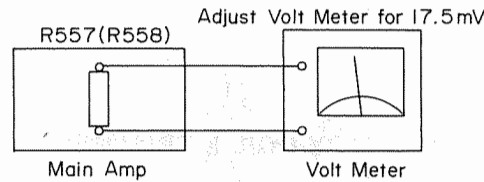

Figure 2

RESET CIRCUIT ALIGNMENT

STEP	ADJUSTMENT	EQUIPMENT	CONNECTION	AUDIO FREQ.	SETTING	LEVEL	ADJUSTMENT
1	Turn trimmer resistor VR 603 counterclockwise (minimum value).						
2		Audio Osc. V.T.V.M. Oscilloscope	See Figure 3.	1000 Hz	VOLUME: Max. BASS, TREBLE BALANCE: center	Adjust input to AUX 1 to get output level of about 6 volts (8 ohm load).	
3	Reset circuit adjustment	Audio Osc. V.T.V.M. Oscilloscope	See Figure 3, 4.	1000 Hz	Same as above	Adjust VR 603 so output drops to zero (RESET comes "on") when output speaker terminals are shorted: DO NOT ADJUST PAST THIS POINT.	VR 603

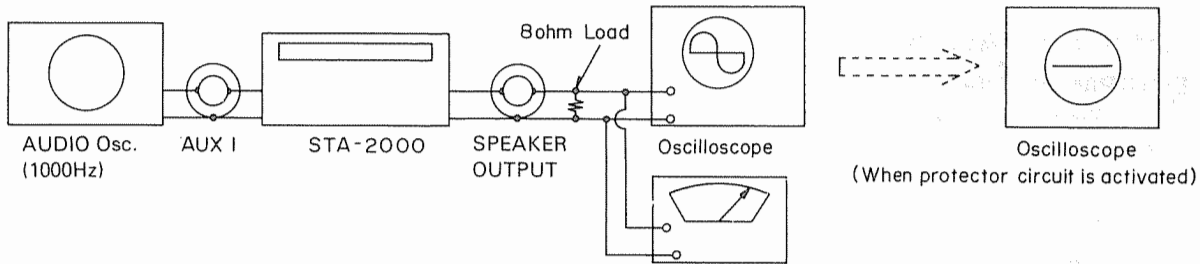

Figure 3

AC V. T. V. M. (6V)

Figure 4

(When protector circuit is activated)

For location of connection points and trimmer resistors, see P.C.B. view.

WATT METER ADJUSTMENT

STEP	ADJUSTMENT	EQUIPMENT	CONNECTION	AUDIO FREQ.	SETTING	LEVEL	ADJUSTMENT
1	WATT Meter level adjustment	Audio Osc. V.T.V.M. Oscilloscope	See Fig. 5.	1000 Hz	VOLUME: Max BASS, TREBLE BALANCE : center	Adjust input to AUX 1 to get output level of 2.8 V (1 W) (8 ohm load).	VR 601 VR 602 VR 604 VR 605

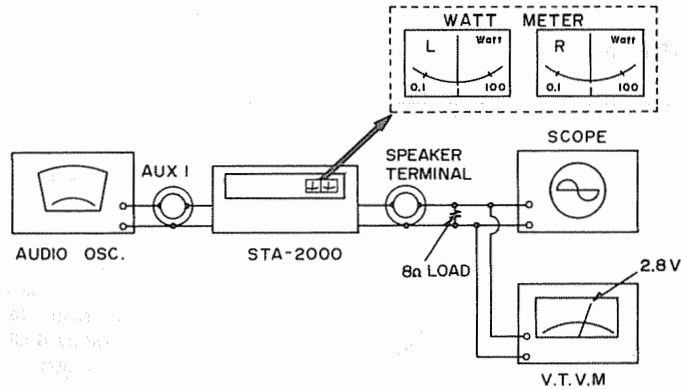

Figure 5

AM-FM IF & MPX COIL & TRIMMER LOCATIONS

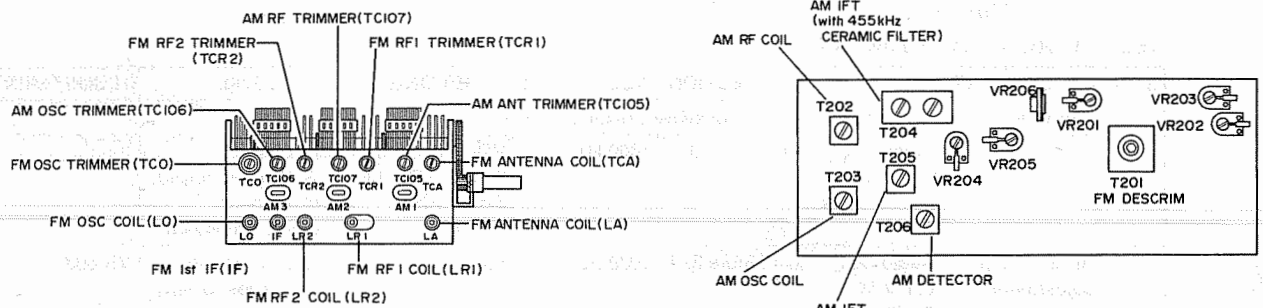

Figure 6

AM IF & RF ALIGNMENT

EQUIPMENT REQUIRED

1. AM Signal Generator
2. AC Voltmeter
3. Oscilloscope
4. Distortion Meter

Note: * Signal generator output should be no higher than necessary to obtain an output reading.
 * Maintain line voltage at 120 volts, 60 Hz AC.
 * Set SELECTOR switch to AM.
 * See P.C.B. illustrations for alignment points/adjustments.

STEP	SIGNAL GENERATOR COUPLING	SIGNAL GENERATOR FREQUENCY	DIAL SETTING	INDICATOR	ADJUSTMENT	REMARKS
1	Connect standard loop ANTENNA to Signal Generator and radiate signal into the AM Ferrite antenna. See Fig. 7.	455 kHz (400 Hz, 30 % Mod.)	Point of non-interference (near 600 kHz)	AC Voltmeter to TAPE OUT 1 Jack	T 204 (Both sections) T 205 T 206	Adjust for maximum reading on meter.
2	Same as above	455 kHz (400 Hz, 80 % Mod.)	Same as above	Distortion Meter and AC Voltmeter to TAPE OUT 1 Jack	T 206	Adjust for minimum Distortion.
3	Same as above	600 kHz (400 Hz, 30 % Mod.)	600 kHz	Same as STEP 1	T 203 (AM OSC Coil) L 101 (AM ANT Coil) T 202 (AM RF Coil)	Adjust for maximum reading on meter. Refer to Fig. 7.
4	Same as above	1400 kHz (400 Hz, 30 % Mod.)	1400 kHz	Same as STEP 1	TC 106 (AM OSC Trimmer) TC 105 (AM ANT Trimmer) TC 107 (AM RF Trimmer)	Adjust for maximum reading on meter. Refer to Fig. 6 and 7.
5	Repeat STEPs 3 and 4 until no further change is noticed.					
6	Same as STEP 1	No Signal	Point of non-interference and no signal	AM strength Meter (TUNING Meter on Receiver	VR 206	Adjust so the Meter Pointer on Receiver is at "0" point on the Meter.
7	Same as STEP 1	1000 kHz (400 kHz, 30 % Mod.) Output level to 100 mV/m	1000 kHz	Same as above	VR 204	Adjust so the Meter Pointer on Receiver is between 85 % and 90 % on the Meter.
8	Same as STEP 1	1000 kHz (Modulated 30 % with 2 kHz) Output level to 2 mV/m	1000 kHz	Same as STEP 1	VR 205	Adjust so Output level increase by 3 dB (AM "wide band" circuit is "ON").

AM ALIGNMENT SET-UP

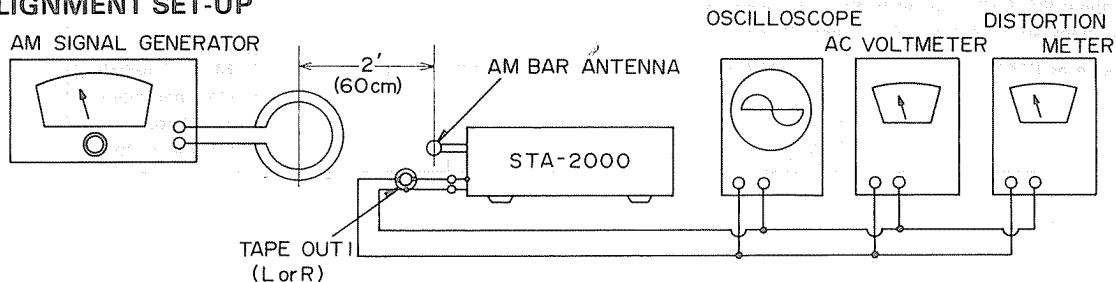

Figure 7

FM RF & IF ALIGNMENT

EQUIPMENT REQUIRED

1. FM Signal Generator
2. AC Voltmeter
3. Oscilloscope
4. Distortion Meter

NOTE:

- * Signal Generator output should be no higher than necessary to obtain an output reading.
- * Maintain Line voltage at 120 volts 60 Hz AC.
- * Set SELECTOR Switch to FM.
- * Refer to P.C.B. illustrations for test points/adjustments.

STEP	GENERATOR COUPLING	GENERATOR FREQUENCY	DIAL SETTING	INDICATOR	ADJUSTMENT	REMARKS
1	Signal Generator to FM Antenna Terminal thru FM Dummy Antenna (300 ohm)	98 MHz (400 Hz, 75 kHz dev.) Input: no input (unit off)	Near to 98 MHz	TUNING Meter	T 201 (Primary)	Adjust for Center Point on TUNING Meter. Refer to Fig. 8, 9 and 10.
2	Same as above	98 MHz (400 Hz, 75 kHz dev.) Input: 1 mV	Same as above	AC Voltmeter Scope and Distortion Meter to TAPE OUT 1 Jack (L or R)	T 201 (Secondary)	Adjust for minimum Distortion (about 0.1 %). Refer to Fig. 8, 9 and 10.
3	Repeat STEPs (1) and (2) until no further improvement is noticed.					
4	Same as STEP (1)	90 MHz (400 Hz, 75 kHz dev.) Input: about 2 - 3 μ V	90 MHz	Same as STEP (2)	LO (FM OSC Coil) LR 1, LR 2 (FM 1st and 2nd RF Coil) LA (FM Antenna Coil)	Adjust for maximum reading on meter. Refer to Fig. 6 and 10.
5	Same as STEP (1)	106 MHz (400 Hz, 75 kHz dev.) Input: about 2 - 3 μ V	106 MHz	Same as STEP (2)	TCO (FM OSC Trimmer) TCR 1, TCR 2 (FM 1st and 2nd RF Trimmer) TCA (FM Antenna Trimmer)	Adjust for maximum reading on meter. Refer to Fig. 6 and 10.
6	Repeat STEPs (4) and (5) until no further improvement is noticed.					
7	Same as STEP (1)	98 MHz (400 Hz, 75 kHz dev.) Input: 10 μ V	98 MHz	Same as STEP (2)	IFT (FM 1st IFT) (FM Front-end Board)	Adjust for maximum reading on meter. Refer to Fig. 6 and 10.
8	Repeat STEP (7) until no further improvement is obtained. Go back and check STEPs (1) and (2) and realign if necessary.					
9	Same as STEP (1)	98 MHz (400 Hz, 75 kHz dev.) Input: 2.5 μ V	98 MHz	Same as STEP (2)	VR 201	"MUTE" switched "ON" and adjust VR 201 for no signal output.

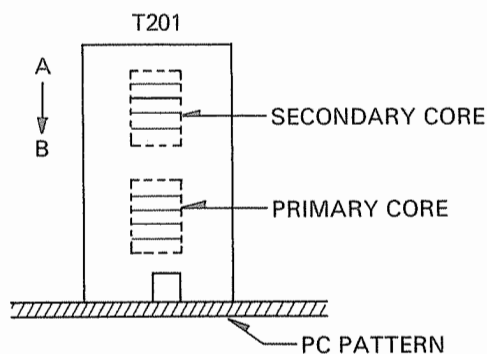

Figure 8

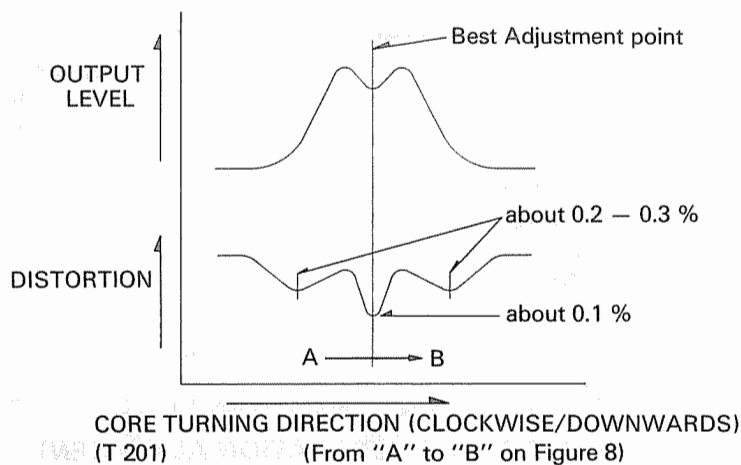

Figure 9

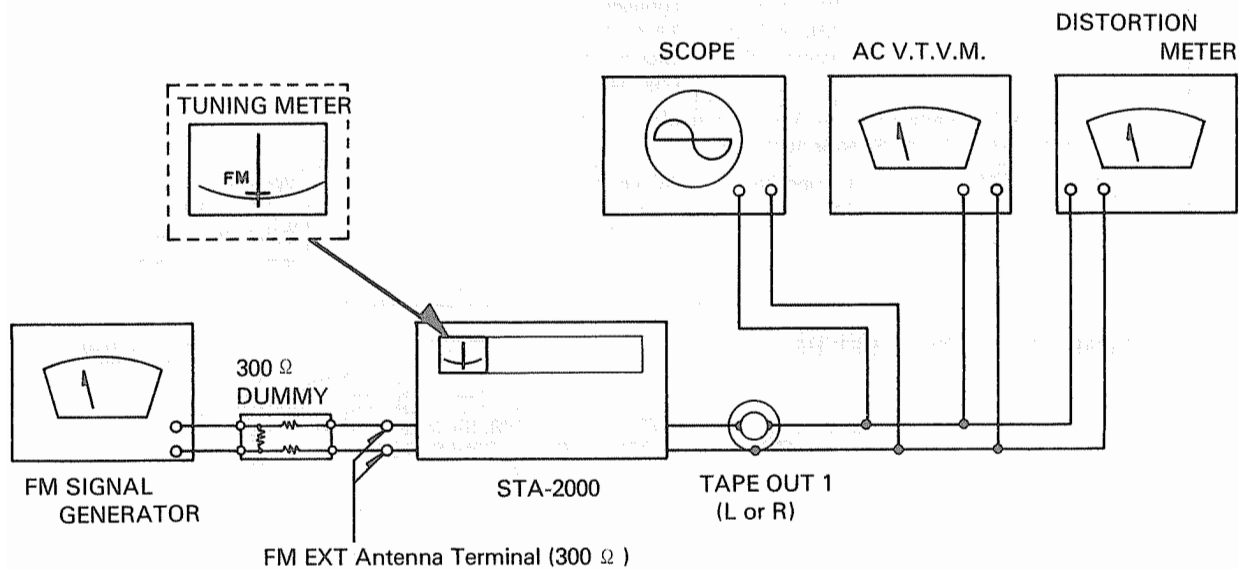

Figure 10

FM STEREO ALIGNMENT

EQUIPMENT REQUIRED

1. Stereo Modulation ---- Connect Stereo Modulator to EXT. Mod. terminal FM Signal Generator.
Modulation Level of 19 kHz Pilot Signal --- 8 — 10 %
2. FM Signal Generator ---- Output Level ---- 1 mV
Frequency ---- Approximately 98 MHz
Deviation ---- 75 kHz, 100 % modulation of composite signal
3. Audio Generator
4. AC Voltmeter
5. Oscilloscope
6. Distortion Meter
7. Frequency Counter

NOTE:

See P.C.B. illustration for alignment/test points.

Preliminaries

Set SELECTOR Switch to FM STEREO and MUTE Switch to "OFF" position.

MULTIPLEX & SEPARATION ALIGNMENT

STEP	SIGNAL GENERATOR COUPLING	STEREO MODULATION	INDICATOR	ADJUSTMENT	REMARKS
1	Connect to FM Antenna terminal thru FM dummy antenna (300 ohm).	Mono. 1 kHz (1000 Hz, No Mod.) Input: 1 mV	Counter connected to TP at Pin No. 12 of IC 202	VR 203	Adjust for 19 kHz \pm 50 Hz on Counter. Refer to Fig. 11.
2	Same as above	Composite MPX Signal 1 kHz on Left channel ONLY	AC Voltmeter connector for TAPE OUT 1 Jack of Right Channel	VR 202 (Separation)	Adjust for minimum reading on meter. Refer to Fig. 2.
3	Same as above	Composite MPX Signal 1 kHz on Right channel ONLY	AC Voltmeter connector for TAPE OUT 1 Jack of Left Channel	Same as above	Same as above
4	Repeat STEPs 2 and 3 until AC Voltmeter reading is at least - 40 dB re same channel output (ie. 40 dB separation).				
5	Same as STEP (1)	Composite MPX Signal 1 kHz	AC Voltmeter connected to TAPE OUT 1 Jack	----	With 10 μ V antenna input signal, Stereo indicator lamp should come on.

FM STEREO ALIGNMENT SET-UP

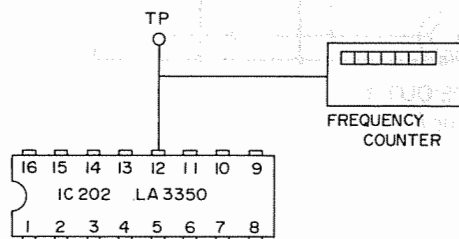

Figure 11

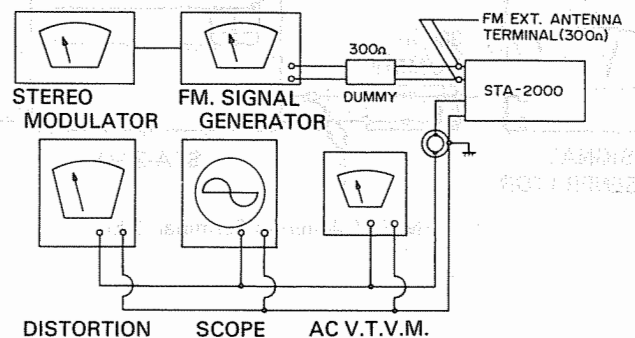

Figure 12

TROUBLESHOOTING

Realistic STA-2000 (31-2075)

SYMPTOM	CAUSE/REMEDY
1) No output	1) Faulty AC power cord * Replace the cord. 2) Defective POWER switch * Replace the switch. 3) Broken wire in the Power Transformer * Replace the Transformer. 4) Blown Primary Fuse * Replace the Fuse.
2) Pilot Lamp does not Light for SELECTOR (AM, FM, PHONO, AUX-1 or AUX-2).	1) Broken Lamp * Replace the Lamp. 2) Open in the Power Transformer tertiary winding * Replace the Transformer.
3) Pilot lamp lights but no Speaker output.	1) Defective capacitor C 1106 or C 1107 * Replace the defective capacitor(s). 2) Defective Rectifier D 1101 * Replace the defective Rectifier. 3) Defect in the Power Transformer secondary winding * Replace the Power Transformer. 4) Defective Power Relay L 601 * Replace the Relay.
4) Blows Fuse.	1) Defective Rectifier D 1101 * Replace the Rectifier. 2) Short-circuit in the rectifier circuit * Remove the short. 3) Short-circuit in Power Transistor Circuitry TR 519-522 * Repair circuit and/or replace the defective Transistor.
5) "A" Speakers do not work.	1) Speaker switch A defective * Replace the switch.
6) "B" Speakers do not work.	1) Speaker switch B defective * Replace the switch.
7) No output one channel with VOLUME at maximum and BALANCE at center, when a test signal is applied to the terminal of non-operating channel of the BALANCE control VR 405/406	1) Defective Transistor TR 401-412, TR 501-524 or TR 601-605 * Replace the defective Transistor(s). 2) Defective resistor or capacitor of TONE, MAIN AMP or PROTECTOR circuit * Replace the defective part(s).
8) No output when a test signal is applied to the input terminals except PHONO input	1) Defective MONO-Stereo or TAPE switch * Replace or repair the switch. 2) Defective Selector switch * Replace the switch.

SYMPTOM	CAUSE/REMEDY
9) No output when a test signal is applied to the PHONO input terminals.	1) Defective transistor, resistor or capacitor of PRE AMP circuit • Replace the part(s). 2) Defective MONO-Stereo or TAPE switch • Replace or repair the switch. 3) Defective Selector switch • Replace the Selector switch.
10) Speaker works normally but Headphone does not work.	1) Defective R 629 (Left) or R 628 (Right) • Change it. 2) Headphone plug does not mate with jack • Replace the plug.
11) All the inputs work normally except "AUX-1" input.	1) Poor contact in "AUX-1" input jack • Repair or replace it. 2) Poor contact in Selector switch • Repair or replace the switch.
12) All the inputs work normally except "AUX-2" input.	1) Poor contact in "AUX-2" input jack • Repair or replace it. 2) Poor contact in Selector switch • Repair or replace the switch.
13) "PHONO" input not operative	1) Poor contact in "PHONO" input jack • Repair or replace it. 2) Faulty Selector switch • Repair or replace it.
14) "TAPE OUT 1" inoperative	1) Poor contact in "TAPE OUT 1" output jack • Repair or replace the jack.
15) "TAPE IN 1" inoperative	1) Poor contact in "TAPE IN 1" input jack • Repair or replace the jack.
16) "TAPE OUT 2" inoperative	1) Poor contact in "TAPE OUT 2" output jack • Repair or replace the jack.
17) "TAPE IN 2" inoperative	1) Poor contact in "TAPE IN 2" input jack • Repair or replace the jack.
18) No AM or FM. (Tuner + B voltage is not 11-12 V.)	1) Broken tertiary winding in the Power Transformer • Replace the Transformer. 2) Defective Diode D 705 or D 706 • Change the defective Diode(s). 3) Faulty capacitor C 705, 706, 717, 718, 719, 720 or 724 • Change the defective capacitor(s). 4) Defective resistor R 713 or 714 • Replace the resistor(s). 5) Zener Diode D 707 defective • Replace the Diode. 6) Short-circuit in Tuner + B circuit • Repair the short. 7) Poor contact in Selector switch • Repair or replace it. 8) Defective Transistor TR 701 • Replace the Transistor.

Realistic STA-2000 (31-2075)

SYMPTOM	CAUSE/REMEDY
19) No FM	1) Poor contact in Selector switch * Repair or replace it. 2) IC, Transistor, Diode, resistor, capacitor, Inductor or IFT of FM IF board defective * Replace the defective part(s). 3) FM Front End defective * Replace the Front End (This board comes assembled). 4) Faulty FM Antenna lead-in/circuitry * Replace or repair the Antenna lead-in/circuitry.
20) No AM	1) Poor contact in Selector switch * Repair or replace switch. 2) Transistor, Diode, IFT, resistor or capacitor of AM IF defective * Replace the defective part(s). 3) Bar-Antenna coil defective * Repair or replace it.
21) No FM MPX Separation	1) Improper adjustment * Readjust VR 202 and VR 203. 2) IC 202 of MPX board defective * Replace the IC. 3) VR 202, 203(Trimmer resistor) defective * Replace the Trimmer resistor. 4) Defective Transistor TR 204, 205, 206 or 207 * Replace the defective Transistor.
22) No STEREO light or FM Stereo does not works.	1) Broken STEREO indicator lamp * Replace the lamp. 2) Defective IC 202 of MPX board * Change the defective IC. 3) Defective Transistor TR 204, 205, 206 and 207 * Replace the defective Transistor(s). 4) VR 202, 203 defective * Replace the defective Trimmer resistor(s).
23) AM Wide Band has no effect (High Frequency, higher than 3 kHz will be increased when signal input is more than about 2 mV/m but this effect does not work).	1) Defective Transistor TR 214, 215 or 216 * Replace the defective Transistor(s). 2) Defective capacitor C 282-287 * Replace the defective capacitor(S). 3) Defective resistor R 294-297 * Replace the defective resistor(s). 4) Defective Diode D 205 or 206 * Replace the defective Diode(s).
24) "LOUDNESS" has no effect.	1) Defective "LOUDNESS" switch * Replace the switch. 2) Defective C 449, 450, R 475-478, R 1114 or 1115 * Replace the defective part(s).

SYMPTOM	CAUSE/REMEDY
25) "Stereo-MONO" not effective	1) Defective Stereo-MONO "MODE" switch • Repair or replace the switch.
26) "MUTING" not effective	1) Defective MUTE switch • Repair or replace the switch. 2) Defective Transistor TR 203 or TR 1001-1004 • Replace the defective Transistor(s). 3) Defective Trimmer resistor VR 201 • Replace the Trimmer resistor. 4) Defective the part(s) of MUTING board • Replace the part(s).
27) "HI MPX FILTER" not effective	1) Defective HI MPX FILTER switch • Repair or replace the switch. 2) Defective C 247 or R 253 • Replace the defective part(s).
28) "-20 dB ATTENUATOR" not effective	1) Defective -20 dB ATTENUATOR switch • Repair or replace the switch. 2) Defective R 1116 or R 1117 • Replace the resistor(s).
29) "TAPE DUBBING 1→2" does not operate.	1) Defective TAPE DUBBING switch • Replace it.
30) "TAPE DUBBING 2→1" does not operate.	1) Defective TAPE DUBBING switch • Replace it.
31) "TAPE MONITOR 1" does not operate.	1) Defective TAPE MONITOR switch • Replace it.
32) "TAPE MONITOR 2" does not operate.	1) Defective TAPE MONITOR switch • Replace it.
33) "BASS" has not effect	1) VR 403, 404 (100 K ohm control) defective • Replace it. 2) Defective R 445-448, 451-456 or C 425-428 of TONE CONTROL board. • Replace the defective part(s).
34) "TREBLE" has no effect.	1) Faulty VR 401 or VR 402 (100 K ohm control) • Replace it. 2) Defective R 441-444, 450, 451 or C 423, 424 of TONE CONTROL board • Replace the defective part(s).
35) WATTs Meter does not work.	1) Defective WATT Meter L or/and R • Repair or replace the Meter. 2) Defective Diode, capacitor or resistor of Meter circuit • Replace the defective part(s). 3) Defective Trimmer resistor VR 601, 602, VR 604 or 605 • Replace the defective Trimmer resistor.

SYMPTOM	CAUSE/REMEDY
<p>36) PROTECTOR circuit does not work.</p>	<ol style="list-style-type: none"> 1) Defective SCR D 604 <ul style="list-style-type: none"> • Replace the defective SCR. 2) Defective resistor or capacitor of PROTECTOR circuit <ul style="list-style-type: none"> • Replace the defective part(s). 3) Defective Diode D 601, 602, or 603 <ul style="list-style-type: none"> • Replace the defective Diode(s). 4) Defective Transistor TR 601-605 <ul style="list-style-type: none"> • Replace the defective Transistor(s). 5) Defective Relay L 601 <ul style="list-style-type: none"> • Replace it.
<p>37) "TUNING" Meter not functioning</p>	<ol style="list-style-type: none"> 1) Defective TUNING Meter <ul style="list-style-type: none"> • Replace it. 2) In case of FM reception, R 226, 228 or C 213 defective <ul style="list-style-type: none"> • Replace the defective part(s). 3) In case of AM reception, VR 204, 206, D 203, 204 C 278-281, or R 293, 298 defective <ul style="list-style-type: none"> • Replace the defective part(s).

FRONT END ASSEMBLY

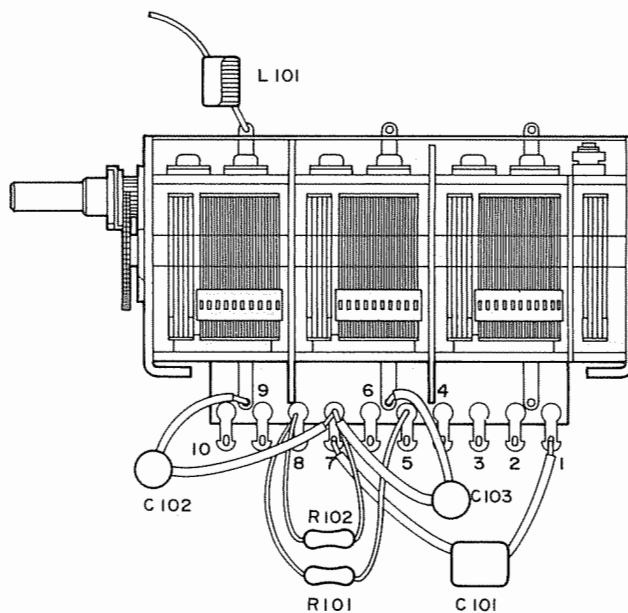

ELECTRICAL PARTS LIST

REF. NO.	DESCRIPTION	RS PART NO.	MFD. PART NO.
CAPACITORS			
C 101	Mylar 0.1 μ F 50WV		
C 102	Ceramic 10 pF 50WV		
C 103	Ceramic 5 pF 50WV		
C 201	Ceramic 0.01 μ F 25WV		
C 202	Ceramic 0.04 μ F 25WV		
C 203	Ceramic 0.02 μ F 25WV		
C 204	Ceramic 0.01 μ F 25WV		
C 205	Ceramic 0.01 μ F 25WV		
C 206	Ceramic 0.02 μ F 25WV		
C 207	Ceramic 0.01 μ F 25WV		
C 208	Ceramic 0.04 μ F 25WV		
C 209	Ceramic 0.04 μ F 25WV		
C 210	Ceramic 0.04 μ F 25WV		
C 211	Ceramic 0.04 μ F 25WV		
C 212	Ceramic 33 pF 50WV		
C 213	Electrolytic 0.47 μ F/50V		
C 214	Electrolytic 10 μ F/16V		
C 215	Ceramic 0.02 μ F 25WV		
C 216	Ceramic 0.04 μ F 25WV		
C 217	Electrolytic 1 μ F/50V		
C 218	Ceramic 0.04 μ F 25WV		
C 219	Ceramic 0.02 μ F 25WV		
C 220	Electrolytic 0.47 μ F/50V		
C 221	Ceramic 0.04 μ F 25WV		
C 222	Electrolytic 100 μ F/16V		
C 223	Ceramic 0.04 μ F 25WV		
C 224	Ceramic 0.04 μ F 25WV		
C 225	Mylar 0.027 μ F 50WV		
C 226	Mylar 0.027 μ F 50WV		
C 227	Electrolytic 100 μ F/16V		
C 228	Ceramic 0.04 μ F 25WV		
C 229	Mylar 0.1 μ F 50WV		
C 230	Aluminum 0.22 μ F/25V		
C 231	Aluminum 0.47 μ F/25V		
C 232	Electrolytic 1 μ F/50V		
C 233	Polystyrene 1500 pF 50WV		
C 234	Mylar 0.047 μ F 50WV		
C 235	Polystyrene 680 pF 50WV		
C 236	Aluminum 0.47 μ F/25V		
C 237	Aluminum 0.47 μ F/25V		
C 238	Mylar 0.0015 μ F 50WV		
C 239	Mylar 0.0015 μ F 50WV		
C 240	Aluminum 0.22 μ F/25V		
C 241	Aluminum 0.22 μ F/25V		
C 242	Ceramic 220 pF 50WV		
C 243	Ceramic 220 pF 50WV		

Realistic STA-2000 (31-2075)

REF. NO.	DESCRIPTION	RS PART NO.	MFD. PART NO.
C 244	Aluminum 0.47 μ F/25V		
C 245	Aluminum 0.47 μ F/25V		
C 246	Electrolytic 220 μ F/16V		
C 247	Mylar 0.0047 μ F 50WV		
C 248	Ceramic 0.04 μ F 25WV		
C 249	Ceramic 0.04 μ F 25WV		
C 250	Ceramic 0.02 μ F 25WV		
C 251	Ceramic 0.02 μ F 25WV		
C 252	Ceramic 0.04 μ F 25WV		
C 253	Ceramic 22 pF 50WV		
C 254	Polystyrene 440 pF 50WV		
C 255	Mylar 0.022 μ F 50WV		
C 256	Ceramic 0.04 μ F 25WV		
C 257	Mylar 0.022 μ F 50WV		
C 258	Ceramic 0.04 μ F 25WV		
C 259	Ceramic 0.04 μ F 25WV		
C 260	Ceramic 0.01 μ F 25WV		
C 261	Ceramic 0.02 μ F 25WV		
C 262	Ceramic 0.04 μ F 25WV		
C 263	Ceramic 0.01 μ F 25WV		
C 264	Ceramic 0.02 μ F 25WV		
C 265	Ceramic 0.04 μ F 25WV		
C 266	Mylar 0.0022 μ F 50WV		
C 267	Electrolytic 4.7 μ F/16V		
C 268	Ceramic 0.04 μ F 25WV		
C 269	Mylar 0.0047 μ F 50WV		
C 270	Electrolytic 4.7 μ F/25V		
C 271	Electrolytic 0.47 μ F/50V		
C 272	Not used		
C 273	Electrolytic 100 μ F/16V		
C 274	Ceramic 0.04 μ F 25WV		
C 275	Electrolytic 100 μ F/16V		
C 276	Electrolytic 0.47 μ F/50V		
C 277	Not used		
C 278	Ceramic 220 pF 50WV		
C 279	Ceramic 0.02 μ F 25WV		
C 280	Electrolytic 100 μ F/10V		
C 281	Ceramic 0.02 μ F 25WV		
C 282	Ceramic 33 pF 50WV		
C 283	Ceramic 0.04 μ F 25WV		
C 284	Electrolytic 10 μ F/16V		
C 285	Electrolytic 10 μ F/16V		
C 286	Electrolytic 10 μ F/16V		
C 287	Mylar 0.027 μ F 50WV		
C 288	Mylar 0.0018 μ F 50WV		
C 289	Electrolytic 1 μ F/16V		
C 290	Electrolytic 22 μ F/16V		
C 301	Tantalum 2.2 μ F/25V		

REF. NO.	DESCRIPTION	RS PART NO.	MFD. PART NO.
C 302	Tantalum 2.2 μ F/25V		
C 303	Ceramic 100 pF 50WV		
C 304	Ceramic 100 pF 50WV		
C 305	Ceramic 47 pF 50WV		
C 306	Ceramic 47 pF 50WV		
C 307	Electrolytic 100 μ F/25V		
C 308	Electrolytic 100 μ F/25V		
C 309	Mylar 0.0018 μ F 50WV		
C 310	Mylar 0.0018 μ F 50WV		
C 311	Mylar 0.0068 μ F 50WV		
C 312	Mylar 0.0068 μ F 50WV		
C 313	Electrolytic 22 μ F/16V		
C 314	Electrolytic 22 μ F/16V		
C 315	Tantalum 0.68 μ F/25V		
C 316	Tantalum 0.68 μ F/25V		
C 317	Electrolytic 100 μ F/35V		
C 318	Ceramic 0.04 μ F 50WV		
C 319	Ceramic 0.04 μ F 50WV		
C 401	Tantalum 4.7 μ F/25V		
C 402	Tantalum 4.7 μ F/25V		
C 403	Electrolytic 100 μ F/10V		
C 404	Electrolytic 100 μ F/10V		
C 405	Ceramic 10 pF 50WV		
C 406	Ceramic 10 pF 50WV		
C 407	Ceramic 22 pF 50WV		
C 408	Ceramic 22 pF 50WV		
C 409	Electrolytic 100 μ F/16V		
C 410	Electrolytic 100 μ F/16V		
C 411	Electrolytic 2.2 μ F/50V		
C 412	Electrolytic 2.2 μ F/50V		
C 413	Electrolytic 100 μ F/10V		
C 414	Electrolytic 100 μ F/10V		
C 415	Ceramic 10 pF 50WV		
C 416	Ceramic 10 pF 50WV		
C 417	Ceramic 22 pF 50WV		
C 418	Ceramic 22 pF 50WV		
C 419	Electrolytic 100 μ F/16V		
C 420	Electrolytic 100 μ F/16V		
C 421	Tantalum 2.2 μ F/25V		
C 422	Tantalum 2.2 μ F/25V		
C 423	Mylar 0.001 μ F 50WV		
C 424	Mylar 0.001 μ F 50WV		
C 425	Mylar 0.039 μ F 50WV		
C 426	Mylar 0.039 μ F 50WV		
C 427	Mylar 0.039 μ F 50WV		
C 428	Mylar 0.039 μ F 50WV		
C 429	Electrolytic 2.2 μ F/50V		

Realistic STA-2000 (31-2075)

REF. NO.	DESCRIPTION	RS PART NO.	MFD. PART NO.
C 430	Electrolytic 2.2 μ F/50V		
C 431	Aluminum 0.47 μ F/25V		
C 432	Aluminum 0.47 μ F/25V		
C 433	Ceramic 10 pF 50WV		
C 434	Ceramic 10 pF 50WV		
C 435	Tantalum 4.7 μ F/25V		
C 436	Tantalum 4.7 μ F/25V		
C 437	Electrolytic 100 μ F/16V		
C 438	Electrolytic 100 μ F/16V		
C 439	Aluminum 0.22 μ F/25V		
C 440	Aluminum 0.22 μ F/25V		
C 441	Ceramic 10 pF 50WV		
C 442	Ceramic 10 pF 50WV		
C 442	Ceramic 10 pF 50WV		
C 443	Tantalum 2.2 μ F/25V		
C 444	Tantalum 2.2 μ F/25V		
C 445	Electrolytic 330 μ F/16V		
C 446	Electrolytic 330 μ F/16V		
C 447	Ceramic 0.04 μ F 50WV		
C 448	Ceramic 0.04 μ F 50WV		
C 449	Mylar 0.018 μ F 50WV		
C 450	Mylar 0.018 μ F 50WV		
C 501	Ceramic 200 pF 50WV		
C 502	Ceramic 200 pF 50WV		
C 503	Tantalum 4.7 μ F/25V		
C 504	Tantalum 4.7 μ F/25V		
C 505	Electrolytic 100 μ F/16V		
C 506	Electrolytic 100 μ F/16V		
C 507	Electrolytic 100 μ F/63V		
C 508	Electrolytic 100 μ F/63V		
C 509	Electrolytic 100 μ F/63V		
C 510	Electrolytic 100 μ F/63V		
C 511	Electrolytic 100 μ F/16V		
C 512	Electrolytic 100 μ F/16V		
C 513	Ceramic 30 pF 50WV		
C 514	Ceramic 30 pF 50WV		
C 515	Not used		
C 516	Not used		
C 517	Mylar 0.0022 μ F 50WV		
C 518	Mylar 0.0022 μ F 50WV		
C 519	Mylar 0.0022 μ F 50WV		
C 520	Mylar 0.0022 μ F 50WV		
C 521	Mylar 0.082 μ F 50WV		
C 522	Mylar 0.082 μ F 50WV		
C 523	Ceramic 0.01 μ F 500WV		
C 524	Ceramic 0.01 μ F 500WV		
C 525	Ceramic 0.01 μ F 500WV		
C 526	Ceramic 0.01 μ F 500WV		
C 527	Mylar 0.1 μ F 100WV		

REF. NO.	DESCRIPTION	RS PART NO.	MFD. PART NO.
C 528	Mylar 0.1 μ F 100WV		
C 529	Electrolytic 0.47 μ F/50V		
C 530	Electrolytic 0.47 μ F/50V		
* C 531	Electrolytic 470 μ F/16V		
* C 532	Electrolytic 470 μ F/16V		
C 533	Ceramic 500 pF 50WV		
C 534	Ceramic 500 pF 50WV		
C 535	Ceramic 500 pF 50WV		
C 536	Ceramic 500 pF 50WV		
C 537	Not used		
C 538	Not used		
C 539	Mylar 0.1 μ F 100WV		
C 540	Mylar 0.1 μ F 100WV		
C 541	Not used		
C 542	Not used		
C 543	Electrolytic 100 μ F/63V		
C 544	Electrolytic 100 μ F/63V		
C 601	Electrolytic 22 μ F/63V		
C 602	Electrolytic 220 μ F/16V		
C 603	Electrolytic 220 μ F/16V		
C 604	Electrolytic 220 μ F/16V		
* C 605	Electrolytic 330 μ F/16V		
C 606	Ceramic 0.04 μ F 50WV		
C 607	Ceramic 0.04 μ F 100WV		
C 608	Ceramic 0.04 μ F 100WV		
C 609	Ceramic 0.04 μ F 100WV		
C 610	Ceramic 0.04 μ F 100WV		
C 611	Electrolytic 47 μ F/50V		
C 612	Electrolytic 47 μ F/50V		
C 701	Ceramic 0.01 μ F 500WV		
C 702	Ceramic 0.01 μ F 500WV		
C 703	Ceramic 0.01 μ F 500WV		
C 704	Ceramic 0.01 μ F 500WV		
C 705	Ceramic 0.04 μ F 50WV		
C 706	Ceramic 0.04 μ F 50WV		
C 707	Electrolytic 220 μ F/50V		
C 708	Electrolytic 220 μ F/50V		
C 709	Ceramic 100 pF 50WV		
C 710	Ceramic 100 pF 50WV		
C 711	Electrolytic 100 μ F/35V		
C 712	Electrolytic 100 μ F/35V		
C 713	Electrolytic 100 μ F/35V		
C 714	Electrolytic 100 μ F/35V		
C 715	Electrolytic 100 μ F/35V		
C 716	Electrolytic 100 μ F/35V		
C 717	Electrolytic 1000 μ F/25V		
C 718	Electrolytic 47 μ F/25V		
C 719	Electrolytic 330 μ F/25V		
C 720	Electrolytic 1000 μ F/16V		
C 721	Ceramic 0.04 μ F 50WV		

* See page 49 for Notice of change during production.

REF. NO.	DESCRIPTION	RS PART NO.	MFD. PART NO.
C 722	Electrolytic 1000 μ F/16V		
C 723	Not used		
C 724	Ceramic 100 pF 50WV		
C 1001	Aluminum 0.1 μ F/16V		
C 1002	Electrolytic 100 μ F/16V		
C 1101	Ceramic 0.01 μ F 125WV		
C 1102	Ceramic 0.01 μ F 500WV		
C 1103	Ceramic 0.01 μ F 500WV		
C 1104	Ceramic 0.01 μ F 500WV		
C 1105	Ceramic 0.01 μ F 500WV		
C 1106	Electrolytic 15000 μ F/63V (Block type)		
C 1107	Electrolytic 15000 μ F/63V (Block type)		
C 1108	Ceramic 0.04 μ F 250WV		
C 1109	Ceramic 0.04 μ F 250WV		
C 1110	Ceramic 0.04 μ F 250WV		
C 1111	Ceramic 0.04 μ F 250WV		
C 1112	Ceramic 0.04 μ F 250WV		
C 1113	Ceramic 0.04 μ F 250WV		
C 1114	Ceramic 1500 pF 50WV		
C 1115	Ceramic 0.02 μ F 50WV		
COILS AND TRANSFORMERS			
L 101	Choke Coil 0.32 μ H		P-360023
L 201	Micro Inductor 18 μ H	C-0709	P-360022
L 202	Micro Inductor 2.2 μ H	C-0708	P-360021
L 501	Choke Coil 2 μ H	CB-2298	P-370009
L 502	Choke Coil 2 μ H	CB-2298	P-370009
L 601	Power Relay MY-4A-02 US	R-8081	P-290012
L 1001	Reed Relay LAB-2S-C 124V	R-8080	P-290010
	Balun Coil 75: 300 ohm	CA-2942	P-110012
	AM Bar Antenna Coil 210 μ H	CA-3464	P-110065
LPF 201	Low Pass Filter Coil	CA-3469	P-510007
T 201	FM IFT 3F-033	CA-7606	P-140033
T 202	AM RF Coil OR-052	CA-4752	P-340052
T 203	AM OSC Coil OC-063	CA-4751	P-120063
T 204	AM IFT (Ceramic Filter) OA-023	C-0275	P-130023
T 205	AM IFT OA-005	CA-7112	P-130005
T 206	AM IFT OA-022	CA-7537	P-130022
	Power Transformer	TA-0579	P-100384
CERAMIC FILTERS			
CF 201	FM Ceramic Filter SFE-10.7 MA-8	CA-7536	P-140030
CF 202	FM Ceramic Filter SFE-10.7 MA-8	CA-7536	P-140030
CF 203	FM Ceramic Filter SFE-10.7 MA-8	CA-7536	P-140030
DIODES			
D 201	Ge Diode 1N-60P or 1S-188		
D 202	Ge Diode 1N-60P or 1S-188		

REF. NO.	DESCRIPTION	RS PART NO.	MFD. PART NO.
D 203	Ge Diode 1N-60P or 1S-188		
D 204	Ge Diode 1N-60P or 1S-188		
D 205	Ge Diode 1N-60P or 1S-188		
D 206	Ge Diode 1N-60P or 1S-188		
D 501	Zener Diode WZ-130		
D 502	Zener Diode WZ-130		
D 503	Varistor VD-1221		
D 504	Varistor VD-1221		
D 505	Varistor VD-1221		
D 506	Varistor VD-1221		
D 507	Si Diode WG-713		
D 508	Si Diode WG-713		
D 509	Si Diode WG-713		
D 510	Si Diode WG-713		
D 511	Si Diode WG-713		
D 512	Si Diode WG-713		
D 513	Si Diode WG-713		
D 514	Si Diode WG-713		
D 515	Ge Diode 1N-60 or 1S-188		
D 516	Ge Diode 1N-60 or 1S-188		
D 517	Ge Diode 1N-60 or 1S-188		
D 518	Ge Diode 1N-60 or 1S-188		
D 519	Si Diode WG-713		
D 520	Si Diode WG-713		
D 521	Si Diode WG-713		
D 522	Si Diode WG-713		
D 601	Si Diode SR-1K-2 or 10D-1		
D 602	Si Diode SR-1K-2 or 10D-1		
D 603	Si Diode WG-713		
D 604	Si Controlled Rectifier (SCR) 2SF 657 or M 21C		
D 605	Si Diode SR-1K-2 or 10D-1		
D 606	Si Diode SR-1K-2 or 10D-1		
D 607	Si Diode SR-1K-2 or 10D-1		
D 608	Si Diode SR-1K-2 or 10D-1		
D 609	Si Diode SR-1K-2 or 10D-1		
D 610	Si Diode SR-1K-2 or 10D-1		
D 611	Si Diode SR-1K-2 or 10D-1		
D 612	Si Diode SR-1K-2 or 10D-1		
*D 613	Si Diode WG-713		
*D 614	Si Diode WG-713		
*D 615	Ge Diode 1N-60 or 1S-188		
*D 616	Ge Diode 1N-60 or 1S-188		
D 701	Si Diode SR-1K-2 or 10D-1		
D 702	Si Diode SR-1K-2 or 10D-1		
D 703	Si Diode SR-1K-2 or 10D-1		
D 704	Si Diode SR-1K-2 or 10D-1		
D 705	Si Diode SR-1K-2 or 10D-1		
D 706	Si Diode SR-1K-2 or 10D-1		
D 707	Zener Diode WX-137		

Realistic STA-2000 (31-2075)

REF. NO.	DESCRIPTION	RS PART NO.	MFD. PART NO.
D 708 D 1101	Si Diode SR-1K-2 or 10D-1 Bridge Type Rectifier S4B-01		
FUSES			
	Fuse Quick Acting 1A, 250V Fuse Quick Acting 2.5A, 250V Fuse Quick Acting 7A, 125V	HF-0069	P-250013 P-250008 P-250101
INTEGRATED CIRCUITS			
IC 201 IC 202	IC LA 1230 IC LA 3350		
FRONT END			
	Front End Ass'y FL526U12-7603	C-4582	P-150020
LAMPS			
PL 1	Wedge Lamp 8V, 0.3A	L-0690	P-240076
PL 2	Wedge Lamp 8V, 0.3A	L-0690	P-240076
PL 3	Wedge Lamp 8V, 0.3A	L-0690	P-240076
PL 4	Fuse Type Lamp 8V, 0.3A		P-240091
PL 5	Wedge Lamp 8V, 0.3A	L-0690	P-240076
PL 6	Lamp with Lead 6V, 60 mA	L-0717	P-240090
PL 7	Lamp with Lead 6V, 60 mA	L-0717	P-240090
PL 8	Lamp with Lead 6V, 60mA	L-0717	P-240090
PL 9	Lamp with Lead 6V, 60 mA	L-0717	P-240090
PL 10	Lamp with Lead 6V, 60 mA	L-0717	P-240090
PL 11	Lamp with Lead 6V, 60 mA	L-0717	P-240090
METERS			
	Tuning Meter $\pm 100 \mu A$, 1.2K ohm Wattage Meter (Right) $200 \mu A$, 1.2K ohm Wattage Meter (Left) $200 \mu A$, 1.2K ohm	M-0314 M-0312 M-0313	P-230047 P-230048 P-230049
PROTECTOR			
	Temperature Protector $95^{\circ}C \pm 5^{\circ}C$	HB-5094	P-290005
RESISTORS UZ = Radial Type J = $\pm 5\%$ PZ = Axial Type K = $\pm 10\%$			
R 101	Carbon $\frac{1}{4}$ W PZ 2.7K ohm J		
R 102	Carbon $\frac{1}{4}$ W PZ 10K ohm J		
R 201	Carbon $\frac{1}{4}$ W UZ 100 ohm J		
R 202	Carbon $\frac{1}{4}$ W UZ 330 ohm J		
R 203	Carbon $\frac{1}{4}$ W UZ 10K ohm J		
R 204	Carbon $\frac{1}{4}$ W UZ 3.9K ohm J		
R 205	Carbon $\frac{1}{4}$ W UZ 1K ohm J		

REF. NO.	DESCRIPTION	RS PART NO.	MFD. PART NO.
SWITCHES			
Sa1-Sa10	Lever Switch B	S-5038	P-180209
	Lever Switch A	S-5039	P-180210
	Rotary Switch (SELECTOR)	S-1226	P-180213
	Push Switch A (MPX FILTER/MUTE/MONO/LOUDNESS)	S-7282	P-180211
	Push Switch B (-20 dB/SPEAKERS/POWER)	S-7283	P-180212
TRANSISTORS			
TR 201	Si Transistor 2SC 1675(L) or (K)		
TR 202	Si Transistor 2SC 1675(L) or (K)		
TR 203	Si Transistor 2SC 536(H)		
TR 204	Si Transistor 2SC 536(H)		
TR 205	Si Transistor 2SC 536(H)		
TR 206	Si Transistor 2SC 536(H)		
TR 207	Si Transistor 2SC 536(H)		
TR 208	Si Transistor 2SC 929(E) or 2SC 829(D)		
TR 209	Si Transistor 2SC 929(E) or 2SC 829(D)		
TR 210	Si Transistor 2SC 929(E) or 2SC 829(D)		
TR 211	Si Transistor 2SC 929(E) or 2SC 829(D)		
TR 212	Si Transistor 2SC 536(H)		
TR 213	Si Transistor 2SC 929(E) or 2SC 829(D)		
TR 214	Si Transistor 2SC 536(H)		
TR 215	Si Transistor 2SC 536(H)		
TR 216	Si Transistor 2SC 536(H)		
TR 301	Si Transistor 2SC 1222(2) (E) or (U)		
TR 302	Si Transistor 2SC 1222(2) (E) or (U)		
TR 303	Si Transistor 2SC 1222(2) (E) or (U)		
TR 304	Si Transistor 2SC 1222(2) (E) or (U)		
TR 305	Si Transistor 2SA 750 (E)		
TR 306	Si Transistor 2SA 750 (E)		
TR 307	Si Transistor 2SC 1222(2) (E) or (U)		
TR 308	Si Transistor 2SC 1222(2) (E) or (U)		
TR 401	Si Transistor 2SC 1222(2) (E) or (U)		
TR 402	Si Transistor 2SC 1222(2) (E) or (U)		
TR 403	Si Transistor 2SA 750 (E, F)		
TR 404	Si Transistor 2SA 750 (E, F)		
TR 405	Si Transistor 2SC 1222(2) (E) or (U)		
TR 406	Si Transistor 2SC 1222(2) (E) or (U)		
TR 407	Si Transistor 2SA 750 (E, F)		
TR 408	Si Transistor 2SA 750 (E, F)		
TR 409	Si Transistor 2SC 1222(2) (E) or (U)		
TR 410	Si Transistor 2SC 1222(2) (E) or (U)		
TR 411	Si Transistor 2SC 1222 (E)		
TR 412	Si Transistor 2SC 1222 (E)		
TR 501	Si Transistor 2SA 750(1) (E)		
TR 502	Si Transistor 2SA 750(1) (E)		
TR 503	Si Transistor 2SA 750(1) (E)		

REF. NO.	DESCRIPTION	RS PART NO.	FMD. PART NO.
TR 504	Si Transistor 2SA 750(1) (E)		
TR 505	Si Transistor 2SC 1953(R) or (S)		
TR 506	Si Transistor 2SC 1953(R) or (S)		
TR 507	Si Transistor 2SB 536(K) or (L)		
TR 508	Si Transistor 2SB 536(K) or (L)		
TR 509	Si Transistor 2SD 261(P) or (Q)		
TR 510	Si Transistor 2SD 261(P) or (Q)		
TR 511	Si Transistor 2SC 945(P) or (Q)		
TR 512	Si Transistor 2SC 945(P) or (Q)		
TR 513	Si Transistor 2SA 733(P) or (Q)		
TR 514	Si Transistor 2SA 733(P) or (Q)		
TR 515	Si Transistor 2SD 381(K) or (L)		
TR 516	Si Transistor 2SD 381(K) or (L)		
TR 517	Si Transistor 2SB 536(K) or (L)		
TR 518	Si Transistor 2SB 536(K) or (L)		
TR 519	Si Transistor 2SD 287(A) (R) or (A) (Q)		
TR 520	Si Transistor 2SD 287(A) (R) or (A) (Q)		
TR 521	Si Transistor 2SB 539(A) (R) or (A) (Q)		
TR 522	Si Transistor 2SB 539(A) (R) or (A) (Q)		
TR 523	Si Transistor 2SC 536(H)		
TR 524	Si Transistor 2SC 536(H)		
TR 601	Si Transistor 2SD 571(K) or (L)		
TR 602	Si Transistor 2SC 1399(P) or (Q)		
TR 603	Si Transistor 2SA 733(P) or (Q)		
TR 604	Si Transistor 2SC 945(P) or (Q)		
TR 605	Si Transistor 2SC 945(P) or (Q)		
TR 701	Si Transistor 2SD 325(E)		
TR 702	Si Transistor 2SD 325(E)		
TR 703	Si Transistor 2SB 511(E)		
TR 1001	Si Transistor 2SC 945(P) or (Q)		
TR 1002	Si Transistor 2SC 945(P) or (Q)		
TR 1003	Si Transistor 2SC 945(P) or (Q)		
TR 1004	Si Transistor 2SC 945(P) or (Q)		
VARIABLE RESISTORS			
VR 201	Trimmer Resistor 50K ohm B	P-6372	P-170037
VR 202	Trimmer Resistor 1K ohm B	P-6370	P-170036
VR 203	Trimmer Resistor 5K ohm B	P-6371	P-170070
VR 204	Trimmer Resistor 50K ohm B	P-6372	P-170037
VR 205	Trimmer Resistor 100K ohm B	P-6373	P-170035
VR 206	Trimmer Resistor 100K ohm B		P-170237
VR 401/402	Potentiometer (TREBLE) 100K B × 2	P-2069	P-170227
VR 403/404	Potentiometer (BASS) 100K B × 2	P-2069	P-170227
VR 405/406	Potentiometer (BALANCE) 250K 1Z × 2	P-3068	P-170228
VR 501	Trimmer Resistor 5K ohm B	P-6371	P-170070
VR 502	Trimmer Resistor 5K ohm B	P-6371	P-170070

REF. NO.	DESCRIPTION	RS PART NO.	MFD. PART NO.
VR 503	Trimmer Resistor 5K ohm B	P-6371	P-170070
VR 504	Trimmer Resistor 5K ohm B	P-6371	P-170070
* VR 601	Trimmer Resistor 1K ohm B	P-6370	P-170036
* VR 602	Trimmer Resistor 1K ohm B	P-6370	P-170036
VR 603	Trimmer Resistor 2K ohm B		P-170238
			or P-170199
VR 1101/2 /3/4	Potentiometer (VOLUME) 200K 3B x 4	P-1698	P-170229

DIAL STRINGING DIAGRAM

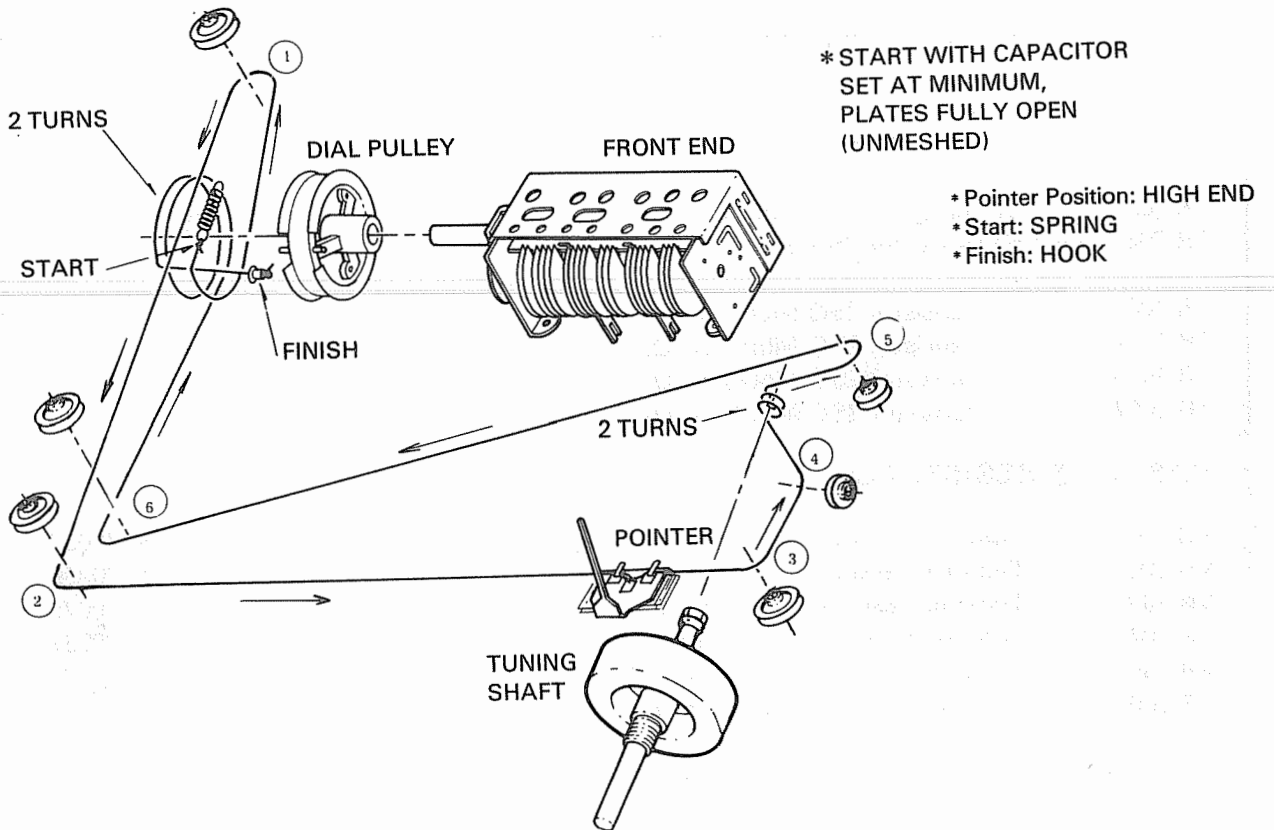

tone AMP P.C.B.

TOP VIEW

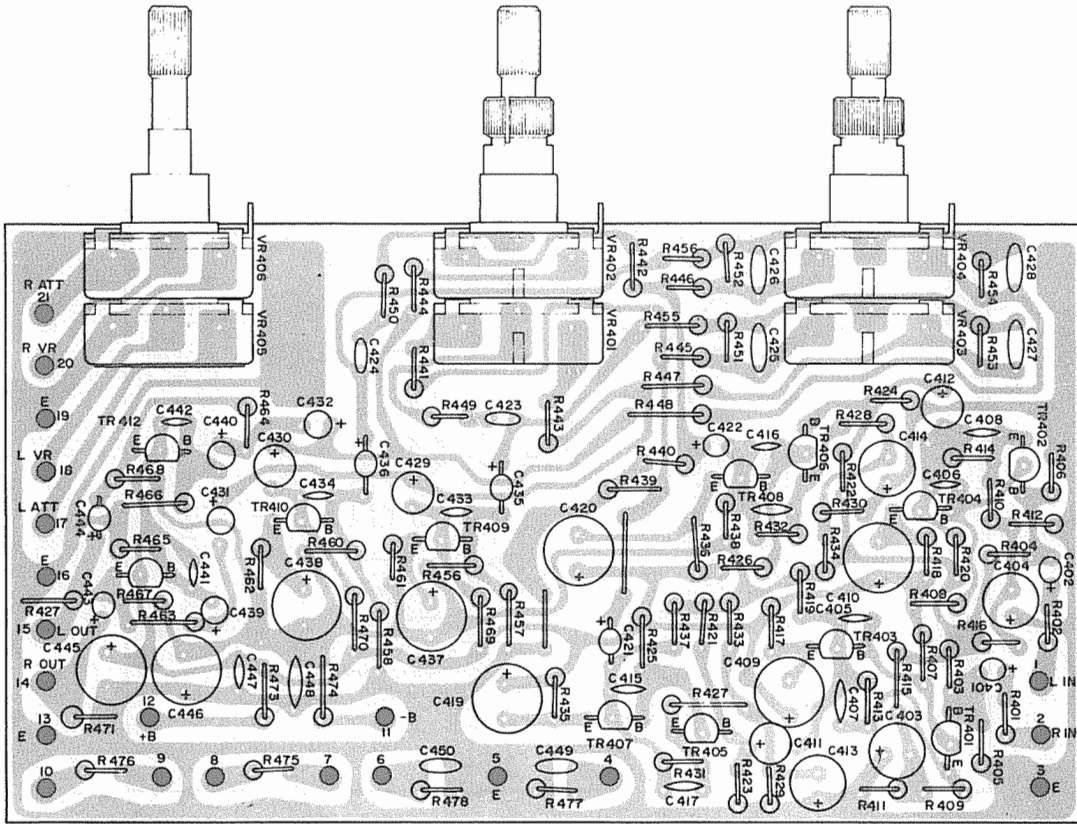

POWER SUPPLY P.C.B.

TOP VIEW

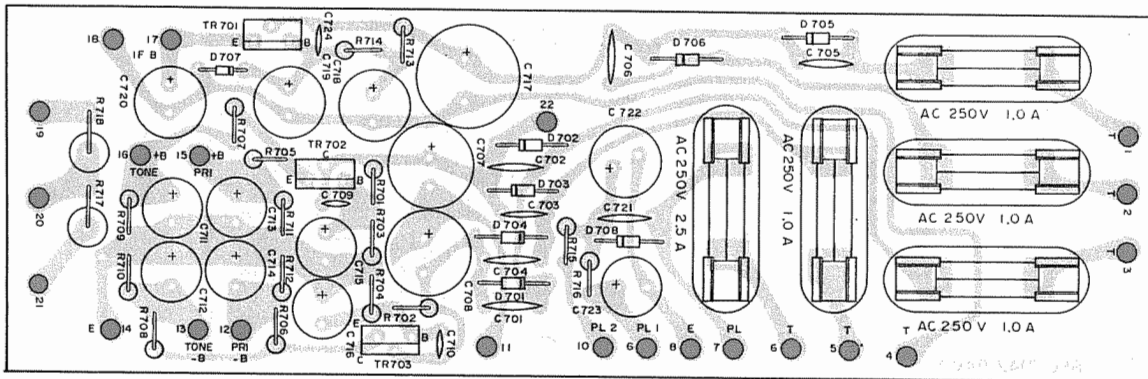

FM MUTING & SWITCHING P.C.B.

TOP VIEW

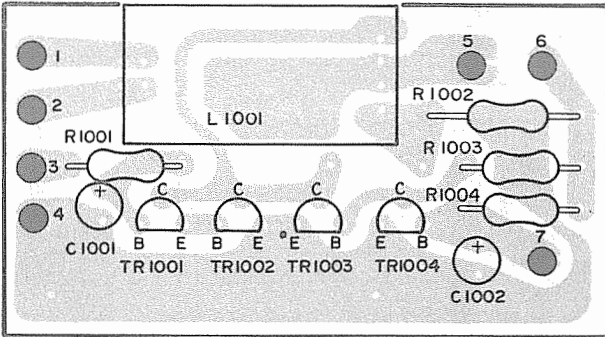

LAMP (A) & LAMP (B) P.C.B. (TOP VIEWS)

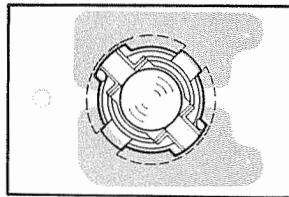
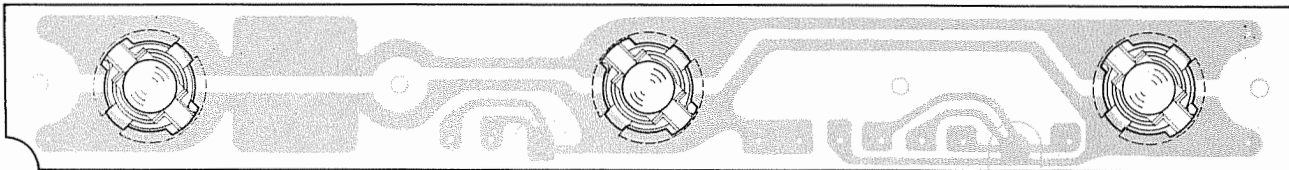

MAIN SUB AMP P.C.B.

TOP VIEW

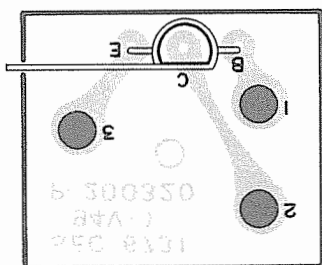

PROTECTOR & METER P.C.B.

TOP VIEW

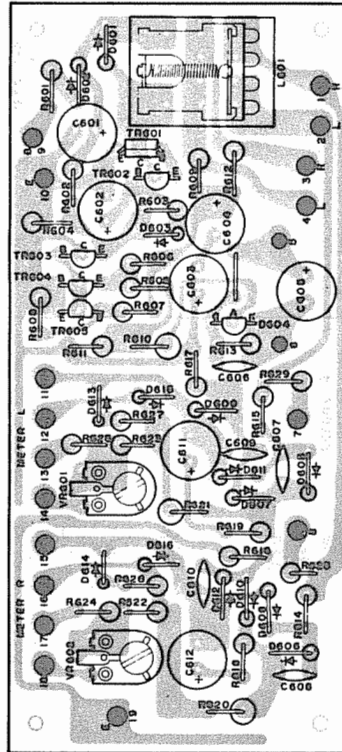

TOP VIEW

After Serial No. 18757

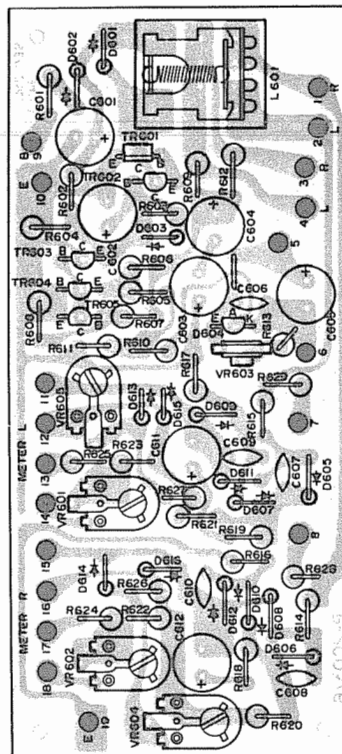

AM/FM IF & MPX P.C.B.

TOP VIEW

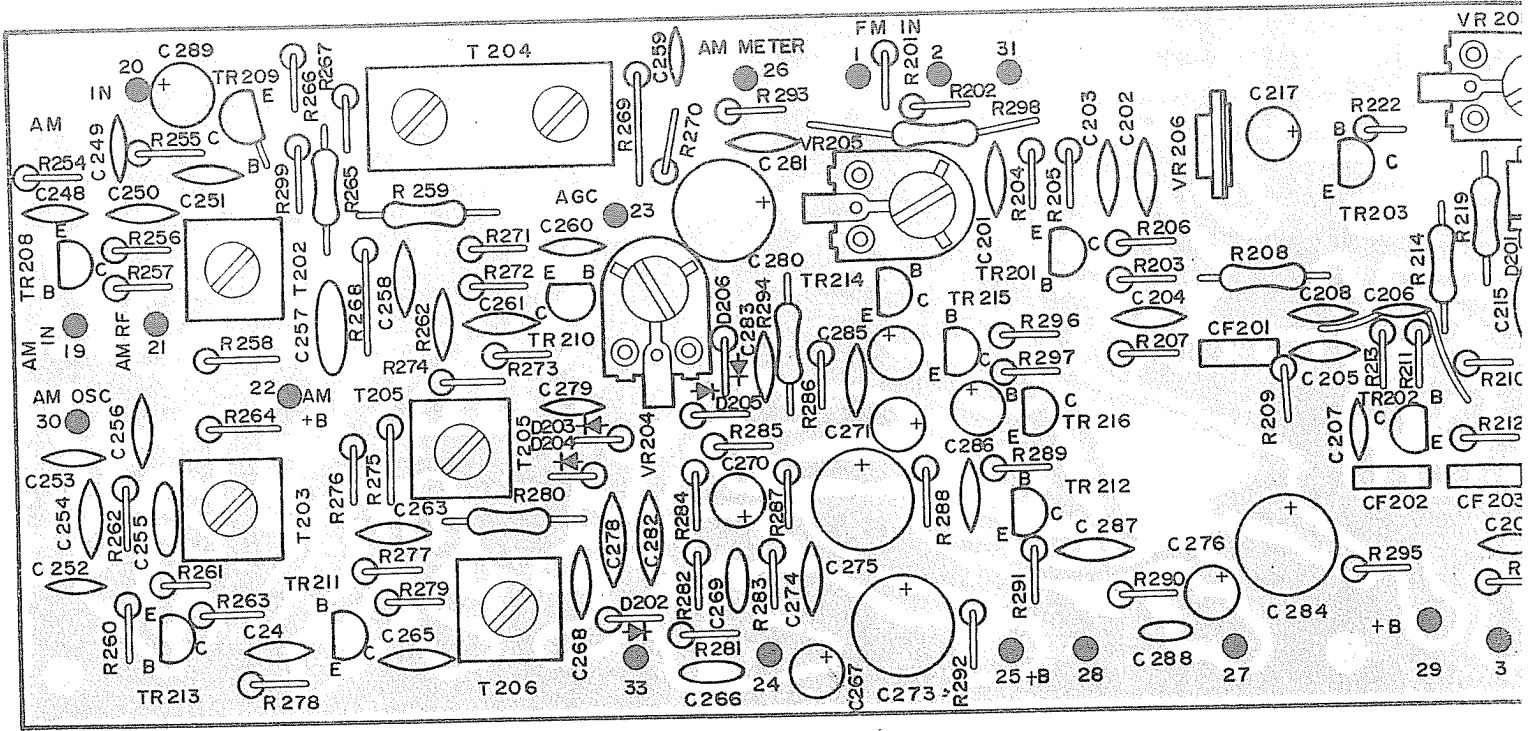

PRE AMP P.C.B.

TOP VIEW

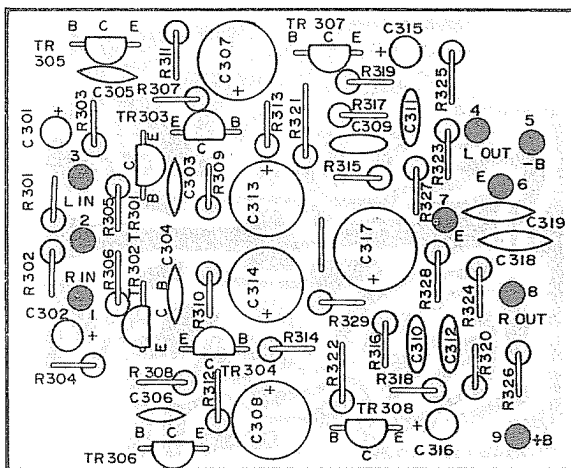

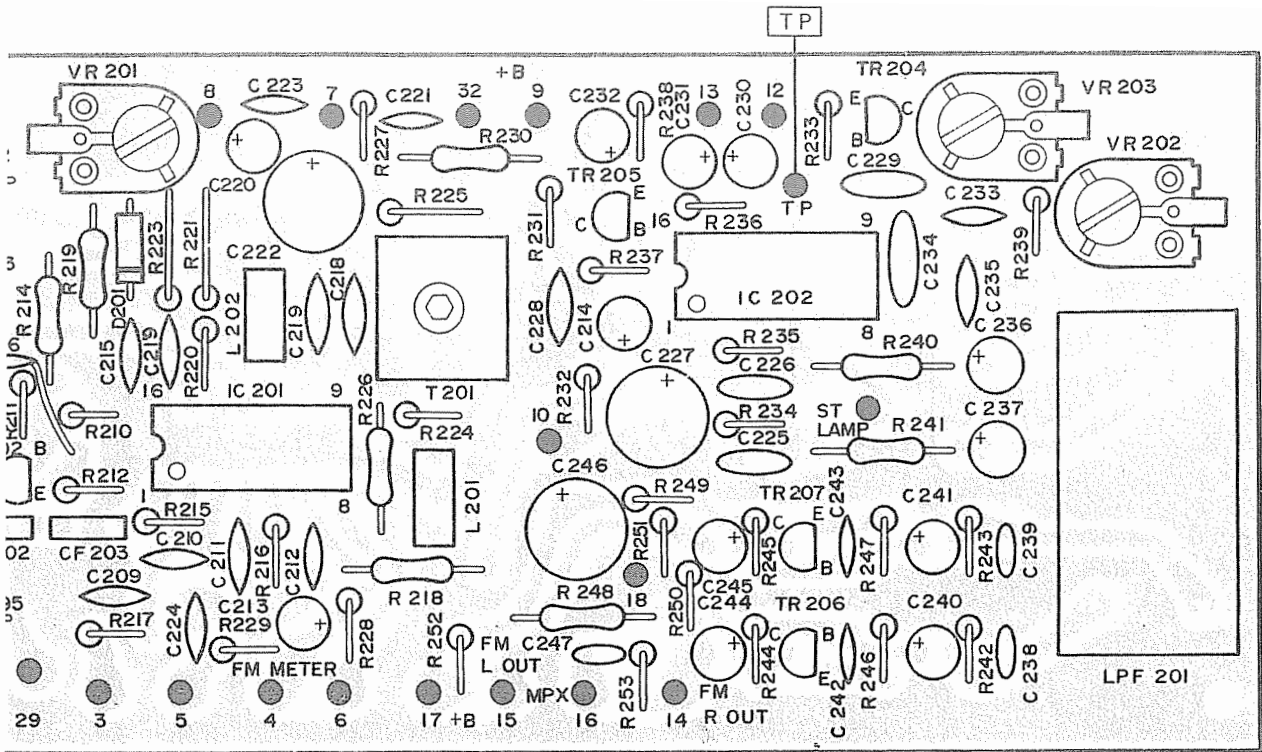

TAPE SWITCH P.C.B.

TOP VIEW

