

Compact Disc Player

Operating Instructions



CDP-C67ES

Owner's Record

The model and serial numbers are located at the rear.
Record the serial number in the space provided below.
Refer to these numbers whenever you call upon your Sony
dealer regarding this product.

Model No. CDP-C67ES Serial No. _____

Warning

**To prevent fire or shock hazard, do not
expose the unit to rain or moisture.**

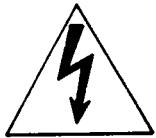
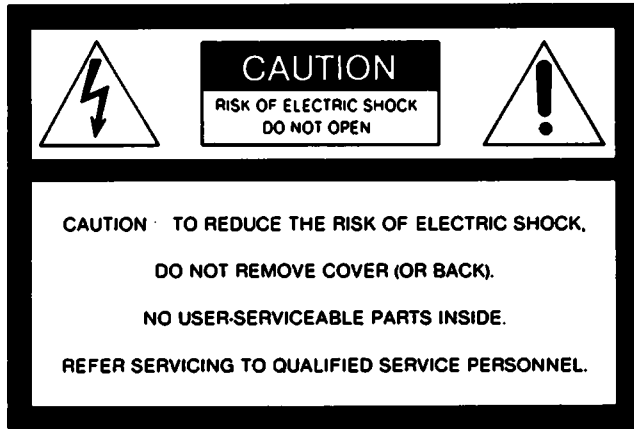

This symbol is intended to alert the user to the presence of uninsulated "dangerous voltage" within the product's enclosure that may be of sufficient magnitude to constitute a risk of electric shock to persons.



This symbol is intended to alert the user to the presence of important operating and maintenance (servicing) instructions in the literature accompanying the appliance.

Information

This equipment generates and uses radio frequency energy and if not installed and used properly, that is, in strict accordance with the manufacturer's instructions, may cause interference to radio and television reception. It has been type tested and found to comply with the limits for a Class B computing device in accordance with the specifications in Subpart J of Part 15 of FCC Rules, which are designed to provide reasonable protection against such interference in a residential installation. However, there is no guarantee that interference will not occur in a particular installation. If this equipment does cause interference to radio or television reception, which can be determined by turning the equipment off and on, the user is encouraged to try to correct the interference by one or more of the following measures:

Reorient the receiving antenna

Relocate the equipment with respect to the receiver

Move the equipment away from the receiver

Plug the equipment into a different outlet so that equipment and receiver are on different branch circuits.

If necessary, the user should consult the dealer or an experienced radio/television technician for additional suggestions. The user may find the following booklet prepared by the Federal Communications Commission helpful:

"How to Identify and Resolve Radio-TV Interference Problems".

This booklet is available from the U.S. Government Printing Office, Washington, D.C. 20402, Stock No. 004-000-00345-4.

Table of Contents

Introduction	3
Precautions	4
Installation	4
Connections	5
Location of controls	6
Front panel	6
Remote commander	7
Installing batteries in the remote commander	7
Playing a disc – Continuous play	8
Information display	9
Selecting a desired disc	10
Locating a particular selection	10
Locating a particular point in a selection	10
Playing in a random order – Shuffle play	11
To play only the desired discs in a random order	
– Select shuffle play	11
Playing in a desired order – Program play	12
Designating the playing time – Program edit	12
Designating the total playing time – Time edit	14
Playing repeatedly – Repeat play	16
Scanning selections – Music scan	17
Tips on editing tapes	18
Fading in/Fading out	18
Fading out after a desired duration – Time fade	18
Locating the loudest portion of the disc	
– Peak search	19
Enhanced surround effects – Digital signal processor	20
Maintenance	21
Cleaning the cabinet	21
Cleaning discs	21
Specifications	21
Troubleshooting guide	22

Note on the Transit Key

The transit key on the bottom exterior of the unit protects the optical system against shock during transportation. Before operating the CD player, be sure to remove the key by following the instructions on the label, and store it in a safe place. When transporting the unit, replace the key in its original hole and lock it in place.

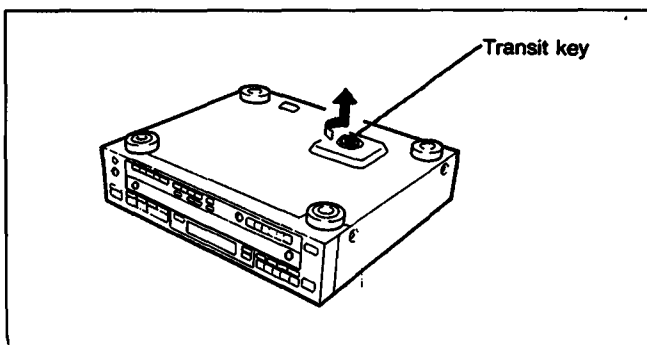

Introduction

This unit is equipped with 5 disc trays which allow you to choose from a large number and wide variety of selections.

Any disc at any time can be played using the DISC 1 to 5 buttons.

Enjoy listening in various playing modes

You can select the playing modes among the following:

- | | |
|--------------------------|---|
| Continuous play (page 8) | – The entire disc(s) is played once. |
| Shuffle play (page 11) | – Selections are played in a random order. |
| Program play (page 12) | – Selections are played in your desired order. |
| Repeat play (page 16) | – Selections or portions are played repeatedly. |

Editing your own tapes

- You can fade the play in or out when making your own tape recording. – Fade in/Fade out (page 18)
- You can confirm the total playing time while choosing the selections to be programmed. – Program edit (page 12)
- The player can program selections automatically to fit in a desired duration. – Time edit (page 14)
- You can stop the play, fading out at the time desired. – Time fade (page 18)
- The loudest portion of the disc will be determined and played repeatedly. – Peak search (page 19)

You can play a beginning of each selection – Music scan

You can check the selections by scanning the beginning of each selection in the disc. You can use this function in any play mode. (page 17)

Enjoy listening in various acoustic atmospheres

The DIGITAL SIGNAL PROCESSOR (DSP) lets you listen to selections according to various acoustic atmospheres. (page 20)

Easy-to-see display

The selection number, the playing time and the remaining time are displayed by pressing the TIME button. And also playing modes like repeat, shuffle, program are displayed in the display window.



This indicates a function operated only from the remote commander.



This indicates a function operated only on the main unit.

Precautions

On safety

- Operate the unit only on 120 V AC, 60 Hz.
- Should any liquid or solid object fall into the cabinet. Unplug the unit and have it checked by qualified personnel before operating it any further.
- Unplug the unit from the wall outlet if it will not be used for a long time. To disconnect the cord, pull it out by grasping the plug. Never pull the cord itself.
- As the laser beam used in this compact disc player is harmful to the eyes, do not attempt to disassemble the cabinet. Refer servicing to qualified personnel only.

On operation

When the unit is not used, turn the power off, to conserve energy and to extend the useful life of your unit.

For detailed safety precautions, see the leaflet "IMPORTANT SAFEGUARDS".

If you have any questions or problems concerning your unit, please contact you nearest Sony dealer.

Installation

Placing Your Unit

- Place the unit in a location with adequate air circulation to prevent internal heat buildup in the unit.
- Do not place the unit on a soft surface, such as a rug that would block the ventilation holes on the bottom.
- Do not install the unit.
 - near heat sources such as radiators or air ducts.
 - in a place subject to direct sunlight, excessive dust, mechanical vibration or shock.

Not this way.

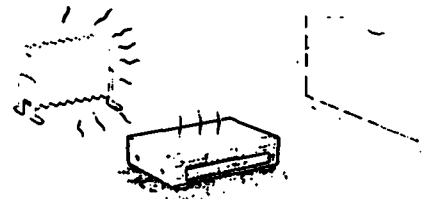

On moisture condensation

If the unit is brought directly from a cold to a warm location, or is placed in a very damp room, moisture may condense on the lens inside the unit. Should this occur, the player will not operate. In this case, remove the disc and leave the player turned on for about an hour until the moisture evaporates.

Connections

For Correct Connections

- Turn off the power of each unit before making connections.
- Connect the AC power cord last.
- Be sure to insert the plugs firmly into the jacks. Loose connection may cause hum and noise.
- Leave a little slack in the connecting cord to allow for inadvertent shock or vibration.
- Cord plugs and jacks are color coded: Red plugs and jacks are for the right channel (R) and white ones for the left channel (L).

To Connect to an Amplifier

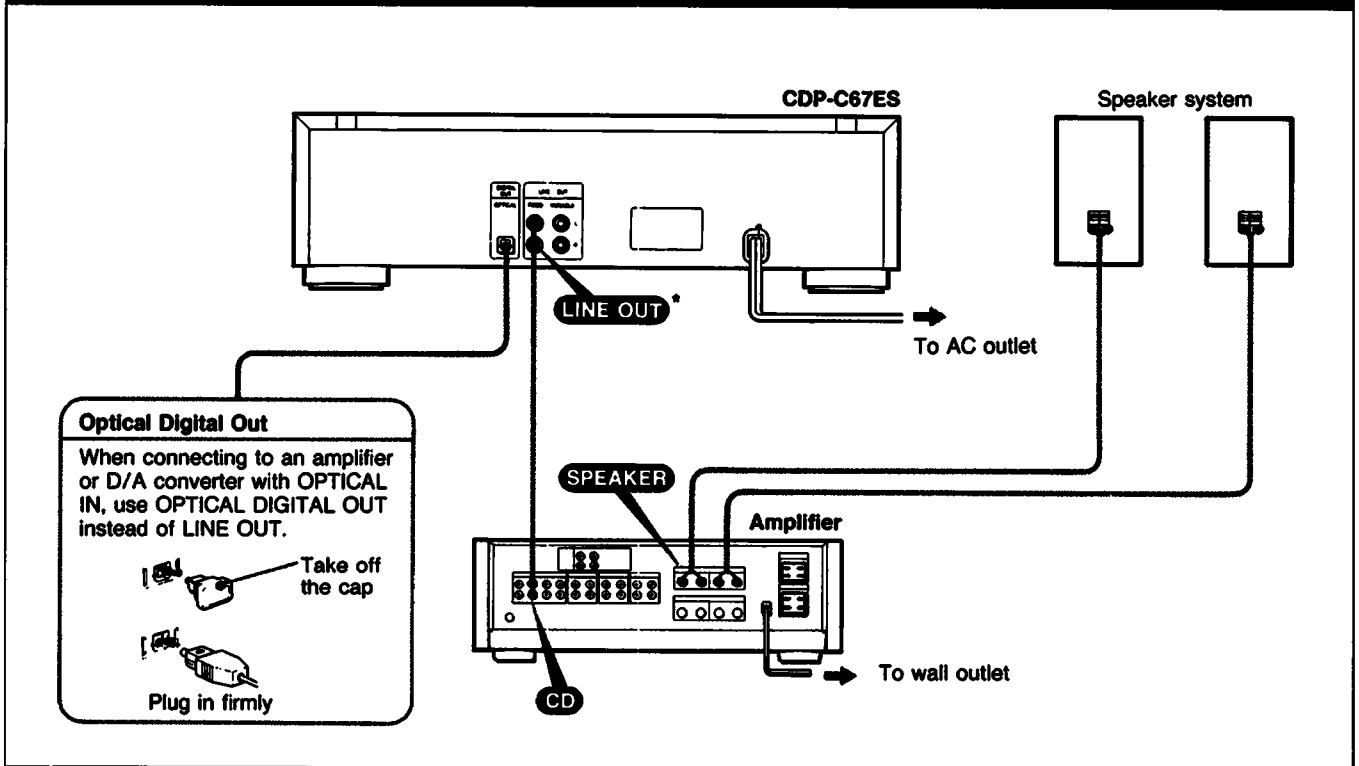

*Notes on LINE OUT

FIXED: The output level is fixed.

VARIABLE: The output level can be adjusted with the LINE OUT/PHONE LEVEL control or LINE OUT LEVEL buttons on the remote commander.

However, if the LINE OUT/PHONE LEVEL control is turned while recording, the recording level will change even when it is preset on the tape deck.

Note on optical digital out

Connect the optical out to the amplifier with the optical input or D/A converter. When you connect, use the connecting cable for optical out POC-15 (optional). When the optical out is connected, you cannot use fade out, fade in, DSP mode and time fade function.

When using the DSP mode, large outputs from the player may cause distortion from your amplifier. In this case, change connections from FIXED to VARIABLE so that you can adjust the output level with the PHONE LEVEL/LINE OUT LEVEL control.

Location of Controls

Front Panel

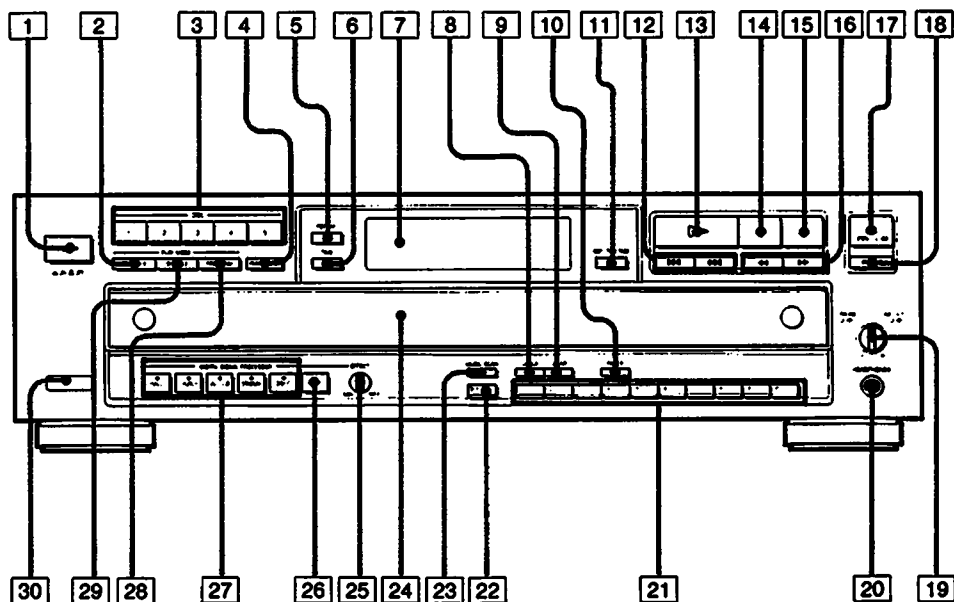

Refer to the pages indicated in ● for details.

- | | |
|----------------------------------|--|
| 1 POWER switch ● | 15 ■ (stop) button ● |
| 2 CONTINUE button ● | 16 ◀/▶ (manual search) buttons ● |
| 3 DISC 1-5 buttons ● | 17 ▲ OPEN/CLOSE button ● |
| 4 PEAK SEARCH button ● | 18 DISC SKIP button ● |
| 5 REPEAT button ● | 19 LINE OUT/PHONE LEVEL control ● |
| 6 TIME button ● | 20 HEADPHONES jack |
| 7 Display window | 21 Numeric buttons (1-10) ● |
| 8 CHECK (program check) button ● | 22 > 10 (over 10) button ● |
| 9 CLEAR (program clear) button ● | 23 MUSIC SCAN button ● |
| 10 FADER button ● | 24 Disc tray ● |
| 11 EDIT/TIME FADE button ● | 25 DIGITAL SIGNAL PROCESSOR EFFECT level control ● |
| 12 ◀◀/▶▶ (AMS*) buttons ● | 26 DIGITAL SIGNAL PROCESSOR FLAT button ● |
| 13 ▶ (play) button ● | 27 DIGITAL SIGNAL PROCESSOR mode select buttons ● |
| 14 (pause) button ● | 28 PROGRAM button ● |
| | 29 SHUFFLE button ● |
| | 30 Remote sensor |

* AMS is the abbreviation of Automatic Music Sensor.

Remote Commander

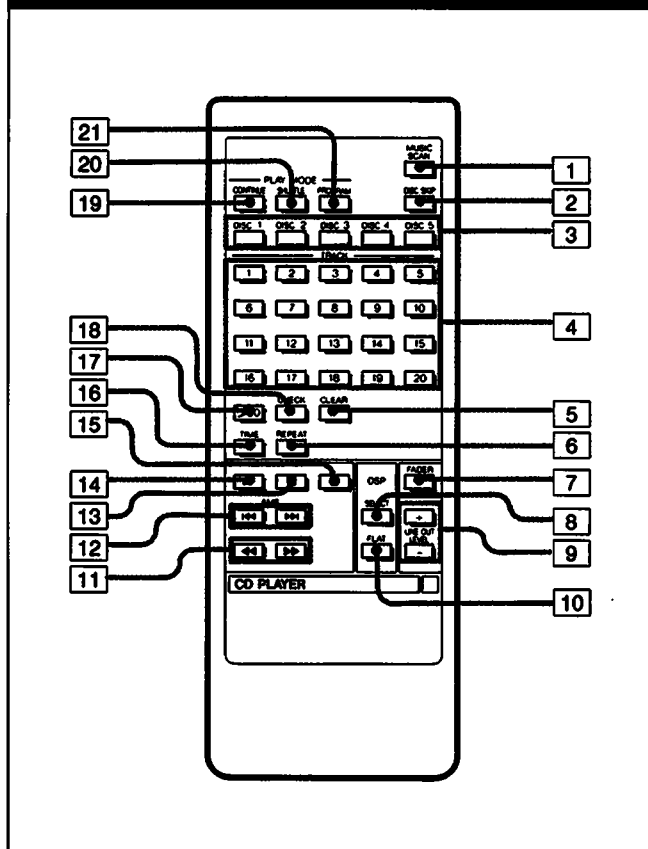

Refer to the pages indicated in ● for details.

- 1 MUSIC SCAN button ①
- 2 DISC SKIP button ②
- 3 DISC 1-5 buttons ③
- 4 Numeric buttons ④
- 5 CLEAR (program clear) button ⑤
- 6 REPEAT button ⑥
- 7 FADER button ⑦
- 8 DSP SELECT button ⑧
- 9 LINE OUT LEVEL buttons ⑨
- 10 DSP FLAT button ⑩
- 11 ◀▶▶▶ (manual search) buttons ⑪
- 12 ◀▶▶▶ (AMS) buttons ⑫
- 13 || (pause) button ⑬
- 14 ▶ (play) button ⑭
- 15 ■ (stop) button ⑮
- 16 TIME button ⑯
- 17 > 20 (over 20) button ⑰
- 18 CHECK (program check) button ⑱
- 19 CONTINUE button ⑲
- 20 SHUFFLE button ⑳
- 21 PROGRAM button ㉑

Installing Batteries in the Remote Commander

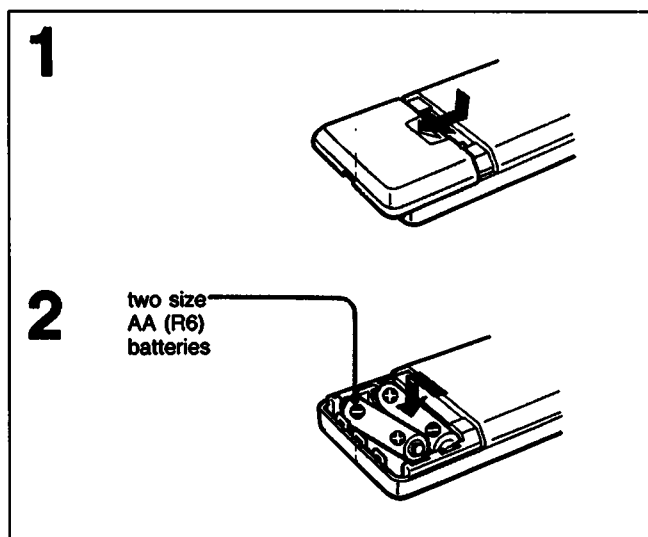

On battery life

- About half a year of normal operation can be expected when using the Sony SUM-3(NS) batteries.
- When the batteries are run down, the remote commander will not operate the unit. In this case, replace both batteries with new ones.

Notes on the remote commander and remote control operation

- Keep the commander away from extremely hot or humid places.
- Avoid dropping any foreign objects into the commander casing, particularly when replacing the batteries.
- Avoid exposing the remote sensor to direct sunlight or lighting apparatus. Such exposure can cause a malfunction.
- To avoid damage caused by battery leakage and corrosion, remove the batteries when the commander will not be used for a long time.

Playing a Disc – Continuous Play

Before playing a disc, turn on the amplifier and set the input selector to the CD player position.

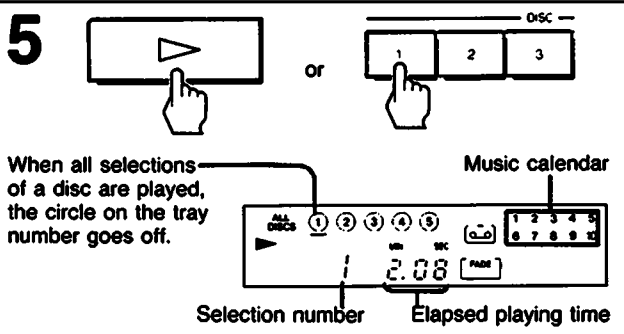
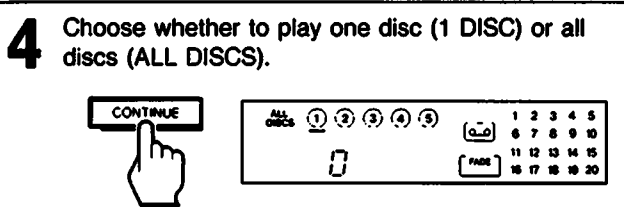
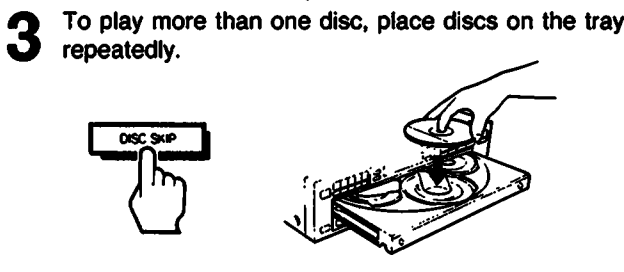
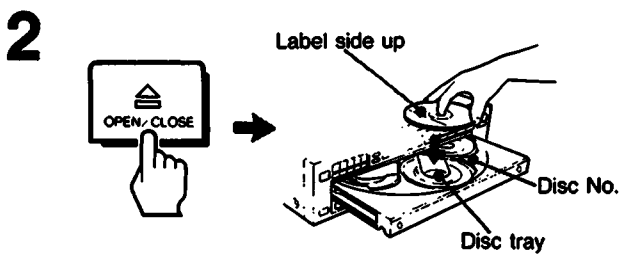
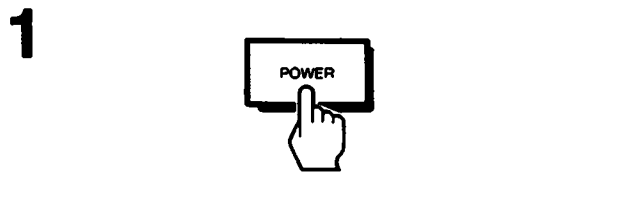
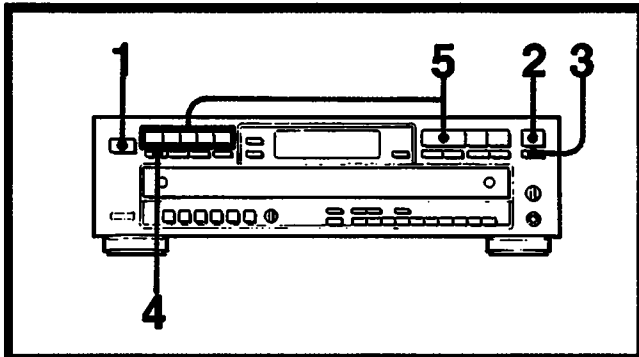

To stop play

To stop for a moment during play, press **II**.

Press **II** or **▶** to resume play.

To stop play, press **■**.

To stop play and open the tray, press **⏏**.

To control the volume

When you use VARIABLE, control the volume with LINE OUT/PHONE LEVEL control of the player or LINE OUT LEVEL of the remote commander. Press + of the remote commander to turn up the volume and press - to turn down the volume. When you press + or -, the LINE OUT/PHONE LEVEL control of the player rotates automatically.

Caution on adjusting volume

Do not turn up the volume while listening to a portion with very low level inputs or no audio signals. If you do, the speakers may be damaged when a peak level portion is played.

To listen with the headphones

Connect the headphones and control the volume with LINE OUT/PHONE LEVEL control or LINE OUT LEVEL buttons on the remote commander.

Note

The tray number of an empty tray will be displayed until the empty tray number is set to play. Once it is recognized as empty, it will disappear.

Notes on handling discs

- To keep the disc clean, handle the disc by its edge. Do not touch the surface.
- Do not stick paper or tape on the disc.

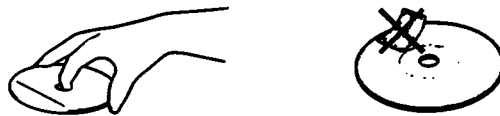

- Do not expose the disc to direct sunlight or heat sources such as hot air ducts, or leave it in a car parked in direct sunlight as there can be a considerable rise in the temperature.
- After playing, store the disc in its case.

To play an 8 cm (3-inch) CD

Place it on the inner circle of the tray. If the disc is provided with an adaptor, first remove it. Do not put a normal CD (12 cm/5-inch) on top of an 8 cm CD.

What is this indication?

no d 15c

This indication appears when there are no disc at all in the tray.

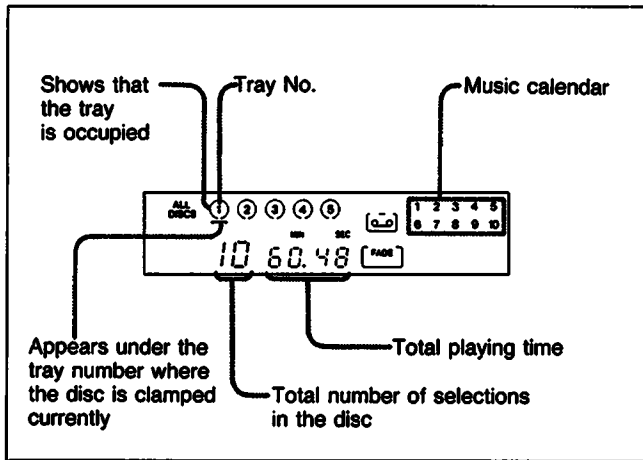

Information Display

If you press  or the compartment itself to close the compartment, the total number of selections and the total playing time of the disc to be played are displayed for a few seconds.

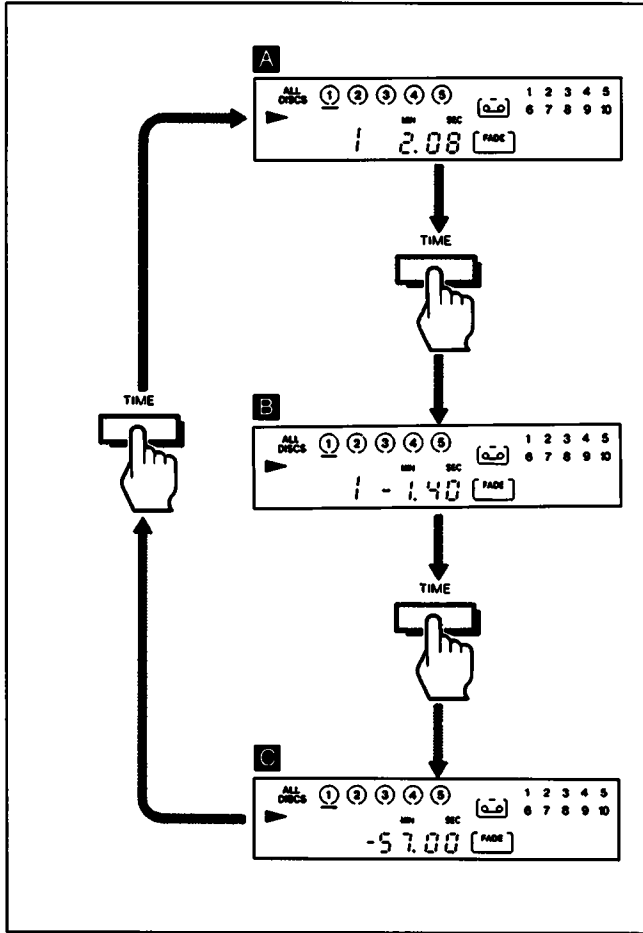

Each time you press TIME during play, the display changes to give you the following information.

- A** Elapsed time in a selection (automatically displayed when play begins)
- B** Remaining time in the selection
“-.-.” indication will appear in the display window instead of the actual time if a selection numbered 21 or higher is selected.
- C** Remaining time of the disc

- Notes**
- Total remaining time is only available during continuous mode. It will not be displayed by pressing the TIME button during program or shuffle mode.
 - Total remaining time will be displayed, if time fade is set during program or shuffle.

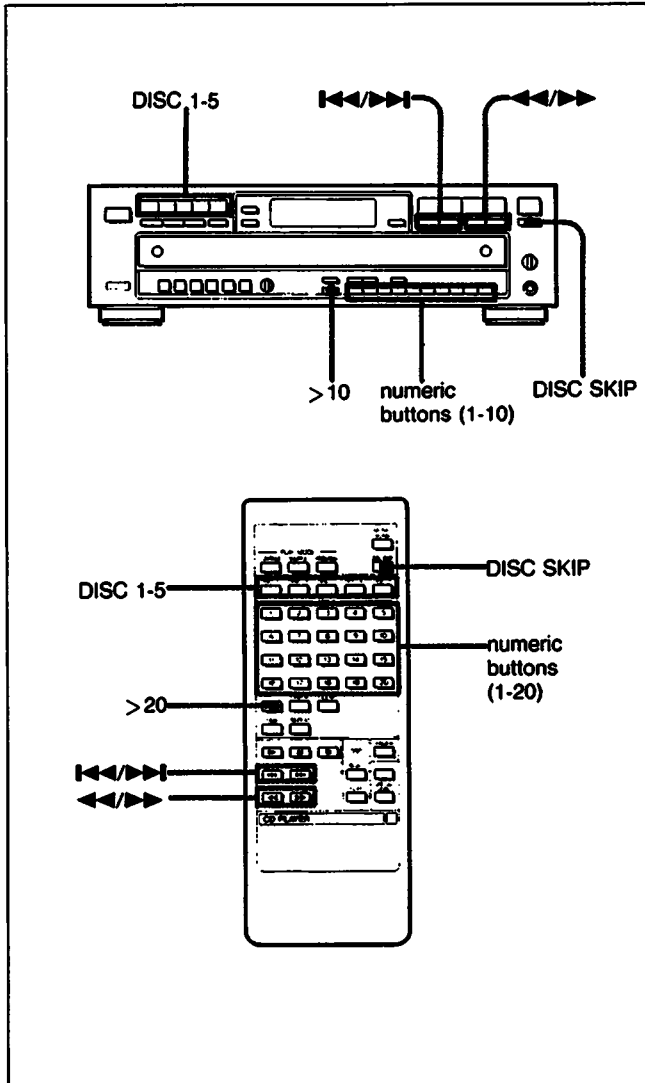

Selecting a Desired Disc

By using the DISC 1 to 5 buttons or the DISC SKIP button during play, you can locate the beginning of any disc.

To select a particular disc	Press the corresponding DISC 1 to 5 button.
To move to the disc tray next to the current one	Press DISC SKIP button.

Locating a Particular Selection

Locating a selection in sequence (Automatic Music Sensor)

You can locate the beginning of a selection on the disc being played.

To locate the beginning of the selection being played	Press ⏮ once.
To locate the beginning of the next selection	Press ⏭ once.

Continue to press until the selection you want is located.

To locate directly

Press one of the numeric buttons to enter the desired selection number.

- **[1]** to **[10]** on the main unit.
To enter a number greater than 10, use the **>10** button.
- **[1]** to **[20]** on the remote commander.
To enter a number greater than 20, use the **>20** button.

e.g. To play from selection No.22

Press **>10** **[2]** **[2]** or **>20** **[2]** **[2]**.

To play from selection No.30

Press **>10** **[3]** **[10]** or **>20** **[3]** **[10]**.

[10] functions as the figure 0.

Locating a Particular Point in a Selection

Locating a point in sequence (Manual Search)

You can locate a particular point in a selection during play by monitoring the high-speed sound.

To go back at high speed	Keep ⏮ pressed.
To go ahead at high speed	Keep ⏭ pressed.

Release the button when you reach the point in the selection you want.

To locate at a higher speed

Press **⏮** or **⏭** in the pause mode. Search speed will increase three times, but there will be no sound. Find the desired point by watching the numbers in the display.

"..." is displayed

If you continuously press **⏭** at the end of the disc, "..." appears in the window. Press **⏮** or **⏮** to return to normal indication.

If you continuously press **⏮** at the beginning of the disc, play begins automatically from the first selection.

Playing in a Random Order – Shuffle Play

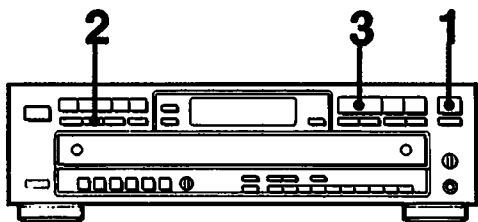

1

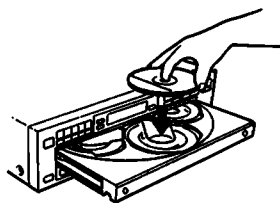

2



Choose whether to play one disc (1 DISC) or all discs (ALL DISCS).

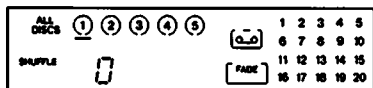

3

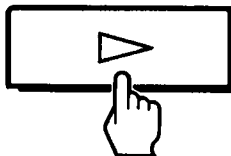

You can have the selections (up to 99) played in a random order. The unit will play all the discs or just one disc you desire.

Once a selection is played, it will not be played again until the random order is completed.

To stop playing

Press ■.

To cancel shuffle play

Press CONTINUE and return to the continuous playing mode.

To change from program or continuous play to shuffle play

Press SHUFFLE during program or continuous play. The program mode will be cleared and shuffle play will begin from the current selection being played.

What is this indication?



This indication appears while the player is "shuffling" the selections.

To Play only the Desired Discs in a Random Order – Select Shuffle Play

Select the desired discs during stop mode (ALL DISCS mode).

To select the desired discs

Press the DISC 1-5 buttons.

A circle will appear around the selected disc number. To choose another disc, press the desired disc number button.

To delete a disc which you have selected, press DISC 1-5 button for that disc. A circle will disappear around the selected disc number.

To put back all discs which you have deleted, press ■ during stop mode.

Note

During shuffle play in ALL DISCS mode, DISC 1-5, MUSIC SCAN, EDIT/TIME FADE, and PEAK SEARCH buttons do not function.

Playing in a Desired Order – Program Play

You can make a program by designating up to 32 steps in the order you want them to be played. The unit will play the disc according to your program.

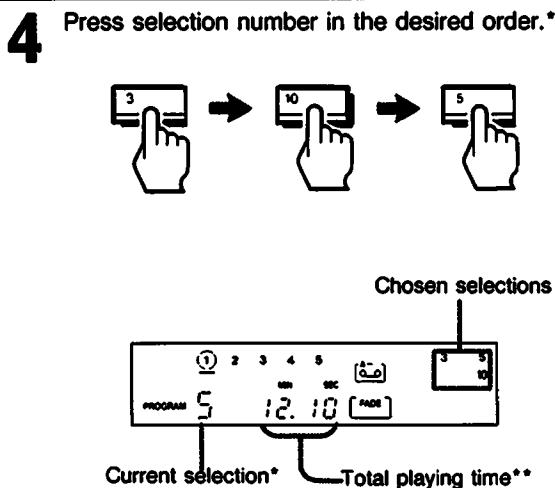
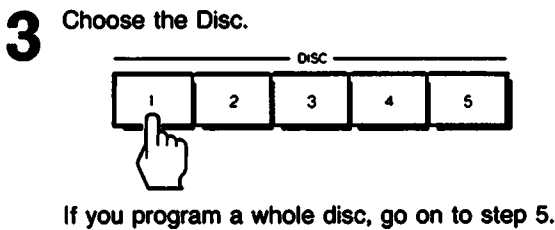
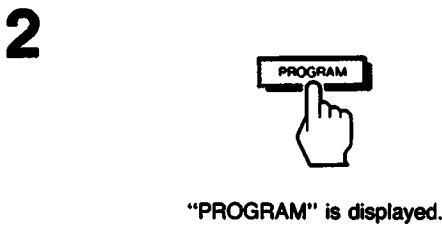
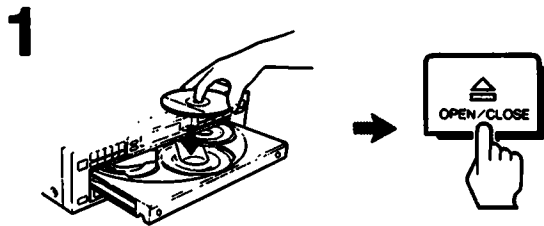
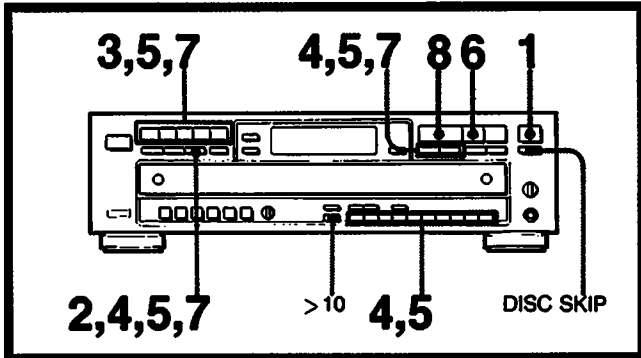

* To choose a selection number over 10 (or 20), see page 10.

Designating the Playing Time – Program Edit

A Choose selection and check the time.

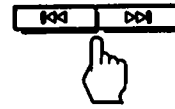

Press ◀▶ repeatedly to choose an appropriate selection.



Current selection Total time

B A satisfactory selection has been chosen.

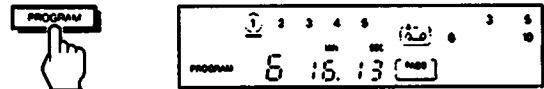

The selection is stored, and the flashing numbers in the window lights up.

5 To program additional selections from the same disc, repeat step 4.
To program additional selections from another disc, repeat steps 3 and 4.

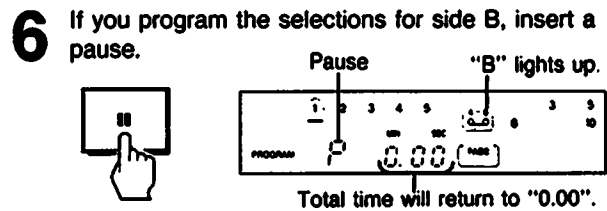

7 Program the selections for side B.
Repeat steps 3 to 4.

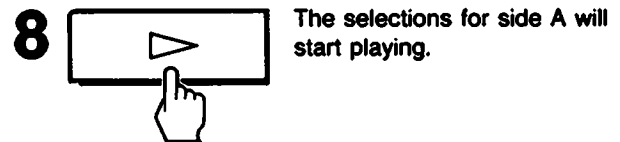

** It may take time for the total playing time of the program to appear. Also, if the total playing time exceeds one hour, the current selection indication will be used to display the hour unit.

You can make a program for both sides (side A and side B) of the tape at one time.
You can program one selection or one disc in a step.

To program a whole disc

- Using the DISC 1 to 5 buttons
After steps 1 and 2:
1 Press the DISC 1 to 5 button to select the disc.
2 Go on to step 5.
- Using the DISC SKIP button.
After steps 1 and 2:
1 Press DISC SKIP button "AL" is displayed in the window.
2 Press PROGRAM.
3 Go on to step 5.

The whole disc is programmed as one step.

To program while observing the disc labels

You can program the selections with the disc compartment open.

To play the selections for side B

When the selections for side A have been played, the unit will pause. ("B" lights up.)

Set the tape to the beginning of side B, then press ► or ■.

The selections for side B will start playing.

To stop program play

Press ■. The last selection number programmed is displayed.

To resume play, press ►. Play begins from the beginning of the program.

You can play the same program repeatedly as long as you do not cancel program play or erase the program.

To cancel program play

Press CONTINUE and return to the continuous playing mode. The program will be erased.

Skipping to the next selection programmed

Press ►► during play.

Going back to the beginning of the selection being played

Press ◀◀ during play.

Display on step 3 (procedure step display)

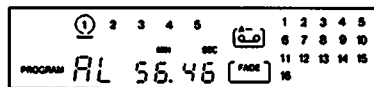
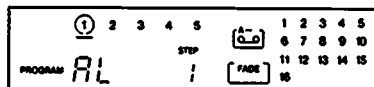

To check your program

Press CHECK. The first selection in the program will be displayed.

Each time you press CHECK, the next selection in the program will be displayed. When CHECK is pressed after the last selection, "End" appears and then the display returns to the initial display.

To change your program

You can make the following changes before starting play.

To erase the last selection, press CLEAR.

Each time you press CLEAR, the last selection in the program will be erased.

To add a selection to the end of the program, just

press the numeric button for that selection. You can add a selection also during play or pause.

To delete a selection, press CHECK repeatedly until the undesired selection is displayed. Then press CLEAR.

To change the order, press ■ during stop to erase the program. Then repeat the programming procedure from the beginning.

To erase the entire program

Press ■ once during stop; twice during play.

The program is also erased when you turn off the unit.

The program will be erased in the following situations

- ■ is pressed during program play.
- Power is turned off.

To check the step of programmed selections

Press TIME during stop mode.

The number of programmed selections will be displayed for few seconds in the window.

To check the remaining time

Press TIME once to see the remaining time of the selection being played; twice to return to the initial display.

The total remaining time cannot be displayed.

If you have programmed a selection number over 20, numeric of STEP is displayed instead of the remaining time.

Notes

- The playing time for selection numbers higher than 20 will not be added into the total playing time.
- When selections have been programmed for sides A and B, the total playing time displayed during stop mode will show the selections programmed for side B and the total playing time for side B.

Designating the Total Playing Time - Time Edit

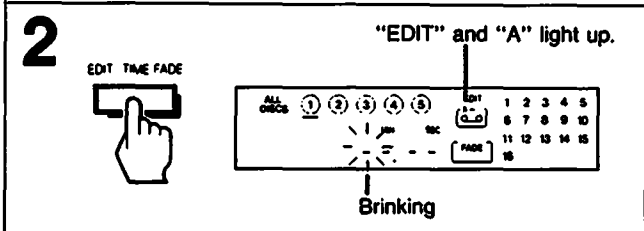
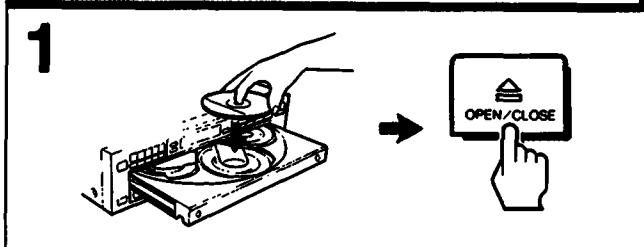
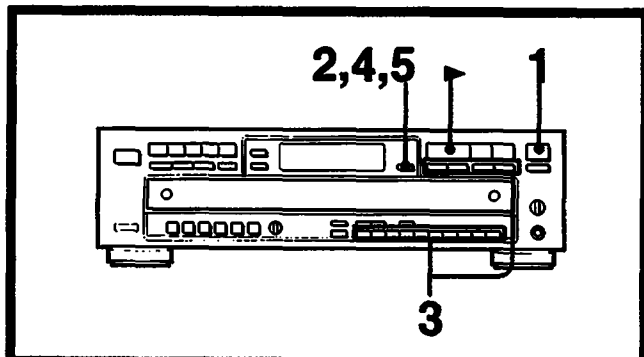

3 Designate the length of one side of your tape.
Example: a 46 minute tape
(23 minutes per side)

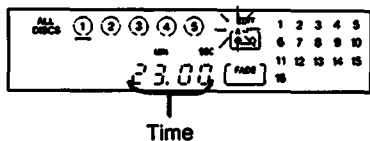
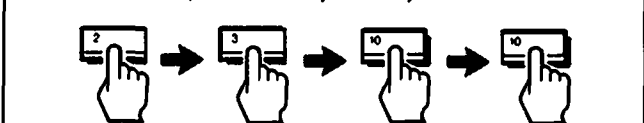

Press **10** for "0".
You need not press keys for seconds, unless required.
You can designate the tape length easily with the **◀◀/▶▶** buttons. Each time you press a button, the time changes in the following way.

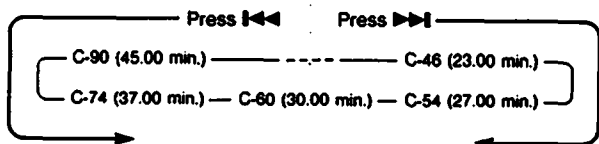

To set the seconds, press **◀◀/▶▶**. The time increases or decreases by 10 seconds.

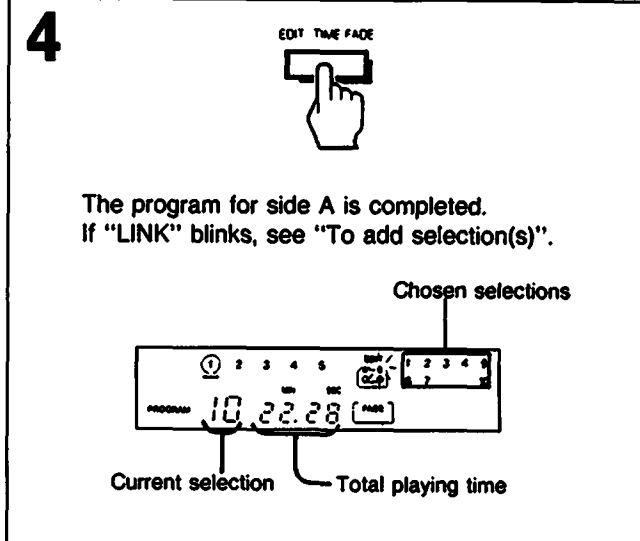
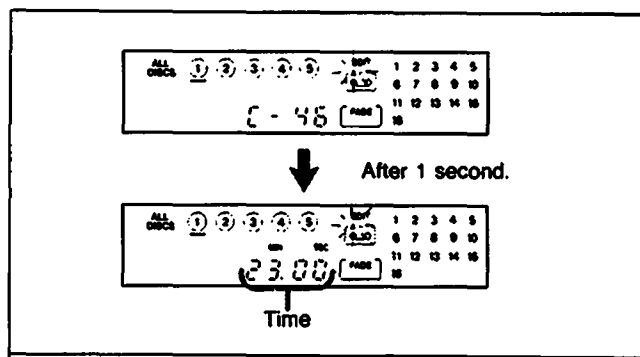

5 Press EDIT/TIME FADE once more, to make a program for the other side of your tape. If "LINK" blinks, see "To add selection(s)".

Note
Total playing time can be set up to 59 minutes 59 seconds.

You can designate a time and the unit will make 2 different programs of selections each fitting within that period. Use this function, by designating the length of your tape, for editing both sides of a tape.

To add selection(s) — LINK —

After all selections on the disc have been programmed, if there is selection(s) within the remaining time, "LINK" and the selection number(s) will blink.

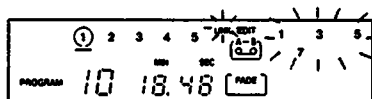

To add selection, press the numeric button for the selection number or press the EDIT/TIME FADE again. When pressing the EDIT/TIME FADE, a program will be made automatically to fit the playing time as close as possible to the remaining time.

If the remaining time can contain other selection(s), "LINK" and the selection number keep blinking. When "LINK" blinks, if the disc is changed by another disc, the new selection number(s) on the new disc that fit in the remaining time will blink.

"EDIT" disappears when the playing time becomes equal to the designated time. Whether "LINK" is blinking or not, you can change the disc by another disc and choose selection(s) to fit the remaining time.

To disappear "EDIT" in the window, press ■ button.

To play the program

Press ►.

The selections for side A will be played and then the unit will pause. "B" lights up in the tape side indicator. Set the tape to the beginning of side B, then press ► or ■■. The selections for side B will be played.

Note

Playback can be performed when "EDIT" is displayed.

To stop playing

Press ■.

You can play the same program repeatedly as long as you do not cancel time edit or erase the program.

To cancel time edit

Press CONTINUE and return to the continuous playing mode.

The program will be erased.

To erase the entire program

Press ■ once during stop; twice during play.

The program is also erased, when you turn off the unit.

To include desired selections in the program

1 Make your own program of the desired selections.

See page 12 for instructions.

2 Follow the procedure as shown on the preceding page.

Just designate the length of your tape; you need not subtract the length of your program. The unit will place your selections at the beginning of its program and add other selections to fit the remaining time.

To check the program

See page 13.

To designate a different time for each side

Execute steps 1 to 4 and press ■■. Then repeat steps 2 and 4. Do not execute step 5.

If your disc has more than 20 selections

Selections over 20 cannot be programmed with the time edit function; program desired selections before using the time edit function. See page 12 for details.

Playing Repeatedly – Repeat Play

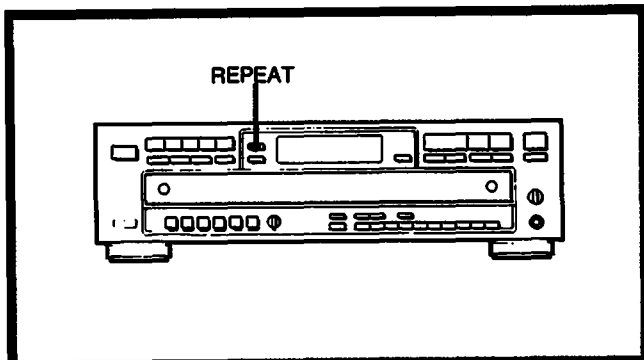

Press before or during play.



"REPEAT" appears. The unit repeats the current playing mode. To repeat a single selection, press REPEAT again during repeat play of the continuous playing mode. "REPEAT 1" appears.

You can repeat a single disc or all the discs.
You can repeat a single selection during continuous play.
You can use repeat play in any play mode.

To cancel repeat play

Press REPEAT again.

"REPEAT" disappears.

To cancel repeat play of the continuous play, press REPEAT twice. "REPEAT" disappears.

Scanning Selections – Music Scan

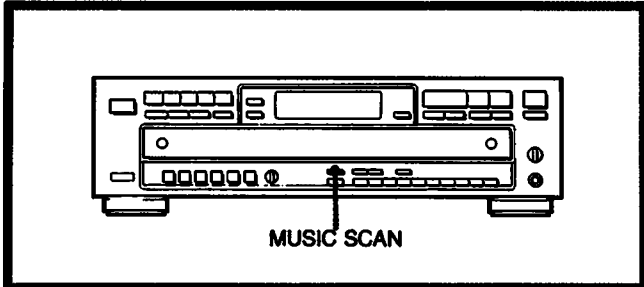

Press during stop.



▶ blinks, and each selection plays for approximately 10 seconds and fades out, scanning play starts the next disc or selection.

You can check the selections by scanning the beginning of each selection on the disc. When "ALL DISCS" is selected in continue mode, the first selection of each disc will be scanned.

You can use this function in any play mode.

To stop music scan play

Press ■.

Starting play at the selection being played during music scan

Press ▶. A ▶ will appear in the window.

Notes

- Programmed pauses in program mode will be disregarded during music scan play.
- If you press the ◀◀/▶▶ button, music scan will be canceled.
- Pressing the MUSIC SCAN button while the beginning of selection is being scanned will extend the playing time for 10 more seconds.

Tips on Editing Tapes

The following functions are convenient for editing your own tapes.

Time Fade and Fade in/Fade out cannot be operated when the DIGITAL (optical) OUT is used for connections.

Fading in/Fading out

You can have the play fade in and fade out between 2-10 seconds.

When no time is specified, the play will fade in and fade out for 5 seconds.

To set the fade time

- 1 Press **■**.
- 2 Press FADER.
- 3 Press **◀◀/▶▶** to select fade time between 2-10 seconds.

To end the play fading out

Press FADER when you want to start fading out.

[FADE] flashes in the window, and play fades out and unit enters the pause mode.

To restart the play fading in

Press FADER in the pause mode.

[FADE] flashes in the window, and play fades in.

Fading out after a desired duration – Time Fade



You can have the play fade out at the end by designating the play duration. Once time fade is set, it functions twice for editing both sides of a tape. You can change discs without canceling this function. The fade time is preset to 5 seconds, but you can change it between 2-10 seconds.

To set time fade

- 1 Press EDIT/TIME FADE twice during stop.

[FADE] is displayed in the window.

- 2 Set the desired play duration, using numeric buttons.

e.g. To set to 27 minutes, press **[2][7][10][10]**.

You need not press buttons for seconds, unless required.

You can designate the tape length easily with the **◀◀/▶▶** buttons. Each time you press a button, the time changes in the following way.

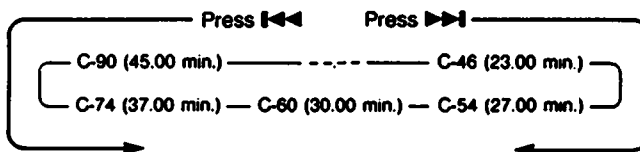

To set the seconds, press **◀◀/▶▶**. The time increases or decreases by 10 seconds.

Note

The desired play duration can be set up to 59 minutes 59 seconds.

- 3 To start play, press **▶**.

After the designated time, play fades out and pauses.

Tape side B lights up. Press **||** or **▶** to resume playing for the other side of the tape. If you press FADER, fade in will start. When the play fades out for the second time, the unit pauses and the time fade function is canceled.

When playback ends in the duration of time fade

Time fade function will be kept on. Change the disc and start playback automatically when the total playing time is within some seconds before the designated time, the player fades out.

To cancel time fade

Time fade will be canceled when

- EDIT/TIME FADE is pressed once again.
- **◀◀/▶▶** (manual search) is pressed during play.

To display the time remaining until the time set

Press TIME twice.

If the PEAK SEARCH is pressed after setting time fade, time fade is released but peak search is kept active.

Locating the loudest portion of the disc – Peak Search

The unit will scan a disc from beginning to end and determine the loudest portion (peak level) of the disc, then play that portion repeatedly. This function will make it easier for you to adjust to the optimum level when recording on tape.

You can use this function in the continuous, shuffle and program play modes.

To set peak search

Press PEAK SEARCH during stop.

“PEAK” blinks in the window. The entire selections in a disc or program will be searched automatically. The loudest portion is played repeatedly for 4 seconds.

Adjust the recording level on your tape deck according to the peak level.

Note

To go to another disc press DISC SKIP button during stop.

To start play immediately

Press ► to play at the first selection of a disc or a program.

To stop peak search

Press ■.

Note on peak search function

The unit determines the loudest portion (peak level) of a disc by searching it at fixed intervals. As a result, the portion searched may differ from the actual peak level. In addition, this function may determine different portions as the peak level for the same disc. However, the difference between the portion searched and the actual peak level is insignificant and will not present any problem in adjusting the recording level.

Enhanced Surround Effects – Digital Signal Processor

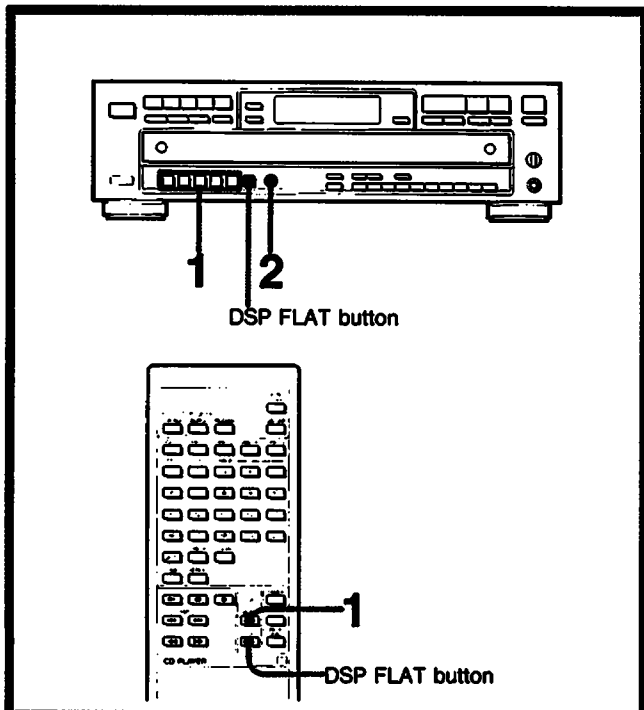

1 Choose the desired DSP mode

Main unit

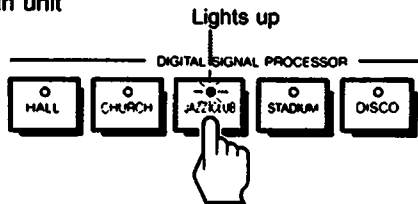

Remote commander



Each press this button will change the DSP mode as follows;

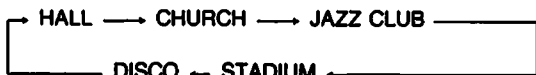

The indicator on the DSP mode select button lights up.

2 Adjust to the desired effect level* (Cannot be controlled from the remote commander.)



The Digital Signal Processor (DSP) lets you listen to selections according to various acoustic atmospheres. These atmospheres are produced by a digital processing technique that involves simulating reflected and reverberated sound effects and digitally compensated frequency response.

You can choose from the following processing mode.

DSP mode	Characteristic
HALL	Reproduces the acoustics of a 2,000 seat capacity concert hall.
CHURCH	Reproduces the acoustics of a church with solid walls, stained glass interior, and high roof.
JAZZ CLUB	Reproduces the acoustics of a modern jazz club.
STADIUM	Reproduces the acoustics of a 30,000 seat capacity out door stadium.
DISCO	Reproduces the acoustics of a discotheque and features strong reverberation with a dynamic bass.

*Adjusting the Effect Level

The EFFECT level control adjusts the surround level and frequency response of the surround effect. Turning this knob toward MAX increases the level and extends the frequency response, while turning it toward MIN reduces these effects. The effect level cannot be adjusted while FLAT is enabled.

To cancel the DSP mode

Press the FLAT button. The DSP mode indicator will turn off.

Notes

- The DSP mode will not be resumed after power failures. Reselect the applicable DSP mode as explained above.
- Noise may occur when switching DSP modes and Effect levels.

About Surround Sound

There are three basic sound effects that produce the acoustics of concert halls and movie theater. Direct sound, early reflection, and reverberation. The acoustic quality of a room depends on how that room reproduces these three sounds.

Types of sounds

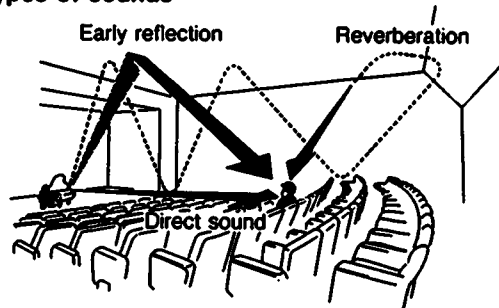

Maintenance

Cleaning the cabinet

Clean the cabinet, panel and controls with a soft cloth lightly moistened with mild detergent solution. Do not use any type of abrasive pad, scouring powder or solvent such as alcohol or benzene.

Cleaning discs

Before playing, clean the disc with the cleaning cloth. Wipe the disc from the center out.

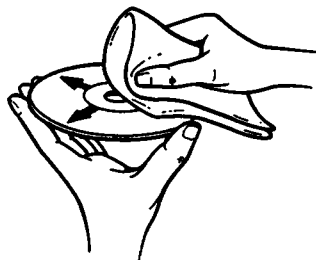

Do not use solvents such as benzene, thinner, commercially available cleaners or anti-static spray intended for analog discs.

After playing, store the disc in its case.

Specifications

System	Compact disc digital audio system
Laser	Semiconductor laser ($\lambda=780$ nm) Emission duration: continuous
Laser output	Max. $44.6 \mu W^*$ * This output is the value measured at a distance of about 200 mm from the objective lens surface on the Optical Pick-up Block.
Frequency response	2 Hz – 20 kHz (± 0.5 dB)
Signal to noise ratio	More than 110 dB
Dynamic range	More than 100 dB
Harmonic distortion	Less than 0.0025% (1 kHz)
Channel separation	More than 105 dB (1 kHz)
Wow and flutter	Below measurable limit
Outputs	
LINE OUT (FIXED) (phono jacks)	Output level 2 V (at 50 kilohms, non DSP mode) Load impedance over 10 kilohms
LINE OUT (VARIABLE) (phono jacks)	Output level max. 2 V (at 50 kilohms, non DSP mode) Load impedance over 10 kilohms
DIGITAL OUT (OPTICAL) (optical output connector)	Wave length 660 nm Output level –18 dBm
HEADPHONES (stereo phone jack)	Output level max. 15 mW Load impedance 32 ohms
General	
Power requirements	120 V AC, 60 Hz
Power consumption	13 W
Dimensions	Approx. $430 \times 125 \times 385$ mm (w/h/d) ($17 \times 5 \times 15\frac{1}{4}$ inches) not including projecting parts and controls
Weight	Approx. 7 kg (15 lbs 7 oz), net
Remote commander	RM-D615
Remote control system	Infrared control
Power requirements	3 V DC with two batteries size AA (IEC esignation R6)
Supplied accessories	
Connecting cord (1) (2 phono plugs \leftrightarrow 2 phono plugs)	
Remote commander (1)	
Size AA batteries (2)	
Operating Manual (1)	
Optional accessory	
Audio Optical connecting cord POC-15	

Design and specifications subject to change without notice.

Troubleshooting Guide

The following checks will assist in the correction of most problems which you may encounter with your unit. Should any problem persist after you have made these checks, consult your nearest Sony service facility. Before going through the check list below, first refer back to the connection and operating procedures.

Trouble	Causes	Remedy
No audio from one or both channels	Incorrect operation of the amplifier	Operate correctly.
	Loose connection	Connect the cords firmly.
Play does not begin.	No disc in the disc compartment	Put disc(s) in the compartment.
	The player is in the pause mode.	Press ► or ■■ to release pause.
	Moisture condensation	Leave the player turned on for about an hour.
	The disc is set upside down.	Set the disc with the label side up.
	The disc is tilted.	Set the disc correctly.
	The disc is extremely dirty.	Clean the disc.
Remote commander does not operate the unit.	The batteries are exhausted.	Replace both batteries.
	The remote commander is not pointed at the remote control sensor.	Point the remote commander to the sensor.
	There is an obstacle between the remote commander and the unit.	Remove the obstacle.
	The remote commander is too far from the unit.	Move closer.
Any operation is not possible.	The internal control program may not run.	Turn off the power and turn it on again.