

ALIGNMENTS AND ADJUSTMENTS

FM FREQUENCY COVERAGE AND TRACKING ALIGNMENT

Never attempt alignment of the fm front-end section for the fm frequency coverage and tracking alignment. If the fm frequency coverage alignment is required, replace the fm front-end board.

In the case of tracking alignment, ask your nearest SONY Service Station to send your set to the Factory Service Center.

AM FREQUENCY COVERAGE AND AM TRACKING ALIGNMENT

Test setup:

FUNCTION selector: AM

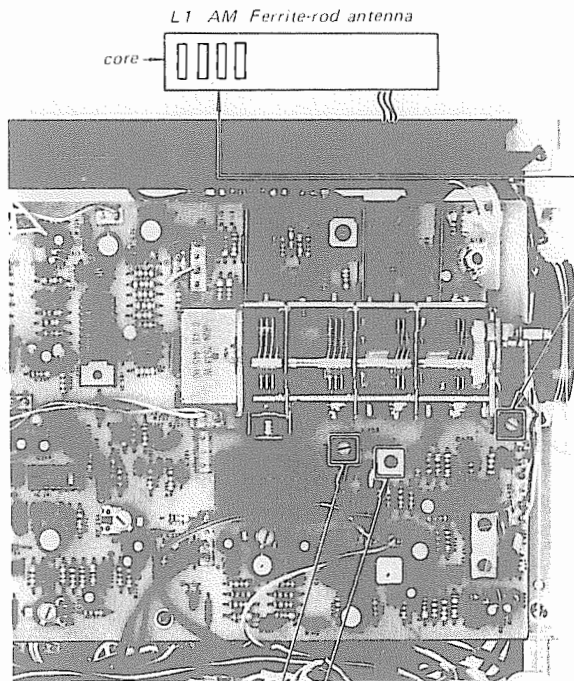
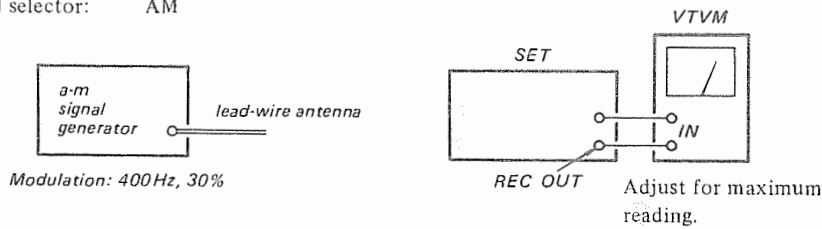

Step	AM TRACKING ALIGNMENT
1	L1 (600 kHz)
2	CT401 (1,400 kHz)

Note: Repeat step 1 and 2 several times, and finish the alignment at step 2.

Step	AM FREQUENCY COVERAGE ALIGNMENT	DIAL INDICATION
1	L402 (520 kHz)	Lower End
2	CT402 (1,680 kHz)	Upper End

Note: Repeat step 1 and 2 several times, and finish the alignment at step 2.

2-6. DIAL CORD STRINGING

1) Dial Cord Length

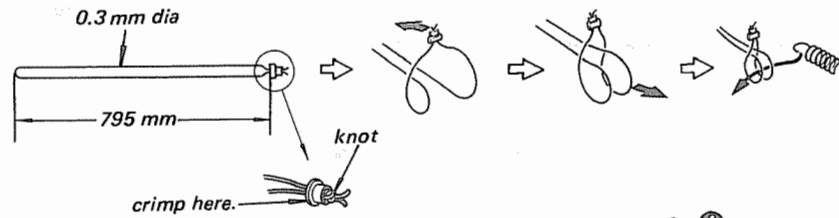

2) Dial Cord Stringing

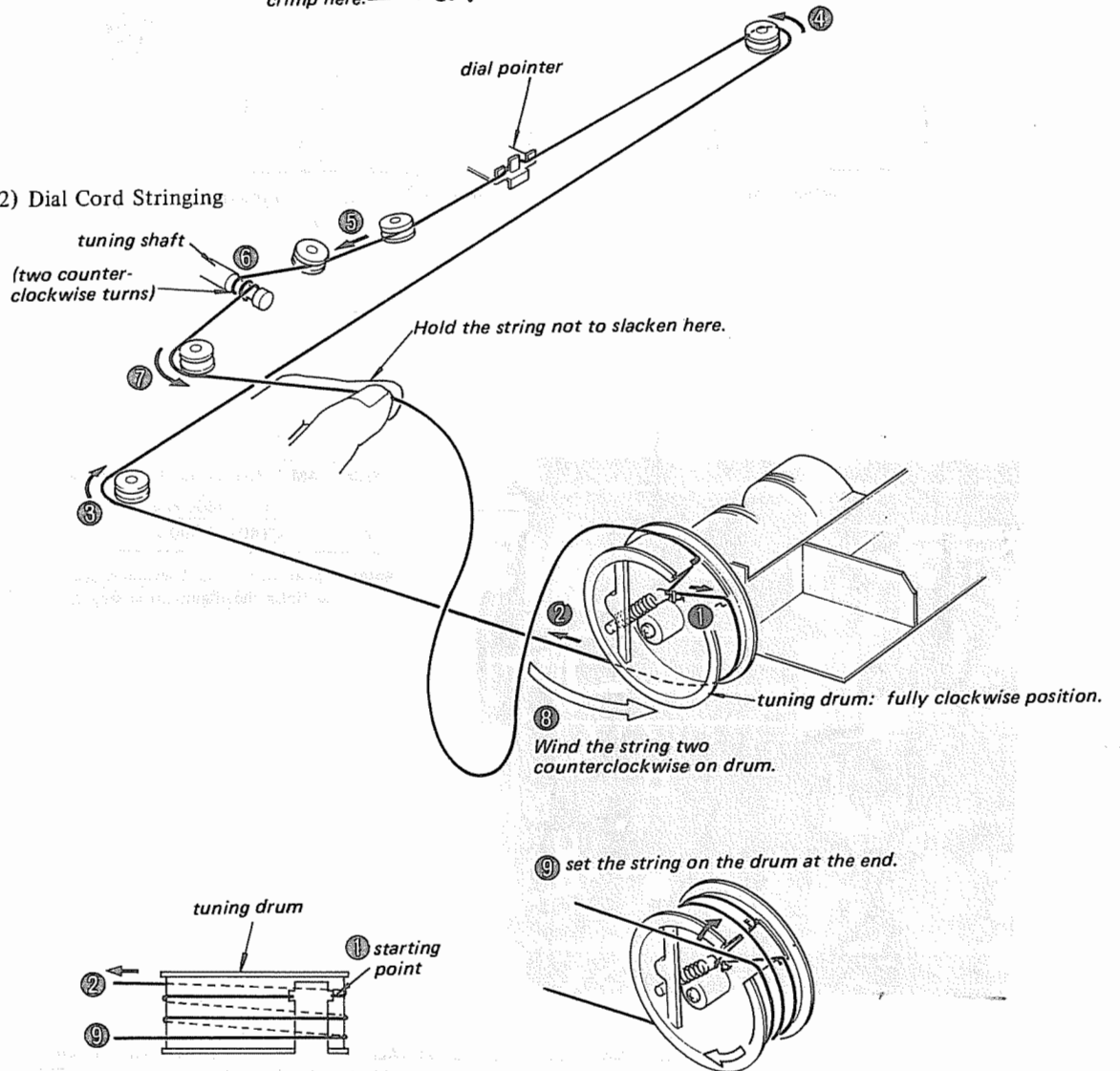

FM OUTPUT LEVEL ADJUSTMENT

Setup:

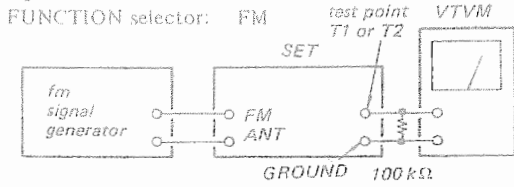

FM Signal Generator Setting:

- Carrier frequency: 98 MHz
- Modulation: 400 Hz, 75 kHz deviation (100%)
- Output level: 1 mV (60 dB)

Procedure:

Adjust RT201 for 870 mV on the VTVM.

DISCRIMINATOR ALIGNMENT

Procedure:

- FUNCTION selector: FM
- 1. Detune the set.
- 2. Adjust the secondary side core of IFT201 for zero center on the TUNING meter.



MPX ADJUSTMENT

Setup:

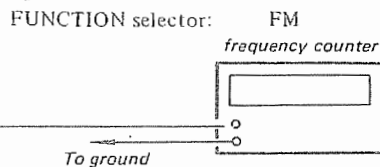

FM Signal Generator Setting:

- Carrier frequency: 98 MHz
- Modulation: no modulation
- Output level: 3.2 mV (70 dB)

Procedure:

Adjust RT205 for 19 kHz \pm 100 Hz on the counter with no input signal.

Note: Perform this adjustment after the power switch turned ON and one minute passed.

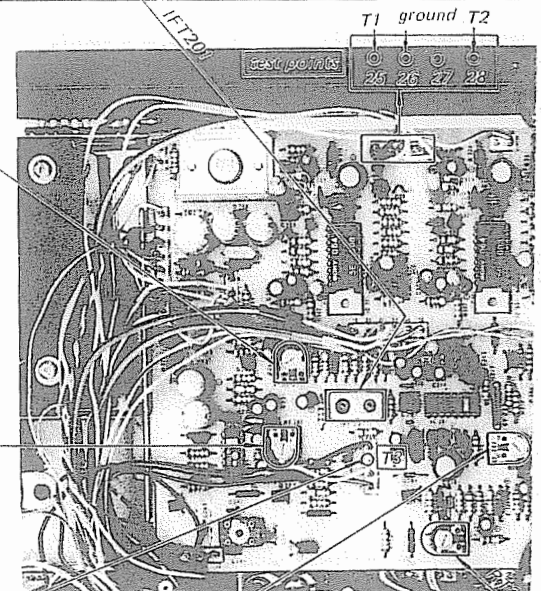

SIGNAL METER ADJUSTMENT

Setup:

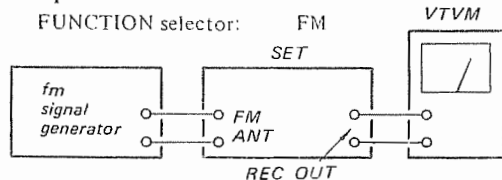

FM Signal Generator Setting:

- Carrier frequency: 98 MHz
- Modulation: no modulation
- Output level: 3.2 mV (70 dB)

Procedure:

Tune the set to 98 MHz and adjust RT204 for specified pointer position (See figure below.) on the SIGNAL meter.

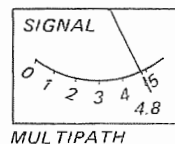

MUTIN

Setup:
FUN
MUT

fm
sign:
gena

FM Sig
Carr
Moc

Proced
1. Set
5.6
2. Adj
to c

FM IF ALIGNMENT

Setup:

FUNCTION selector: FM

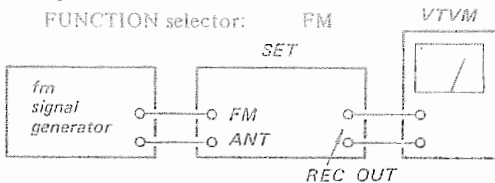

FM Signal Generator Setting:

Carrier frequency: 98 MHz

Modulation: 400 Hz, 75 kHz deviation
(100%)

Output level: 1 mV (60 dB)

Procedure:

Tune the set to 98 MHz and adjust IFT101 for maximum reading on the VTVM.

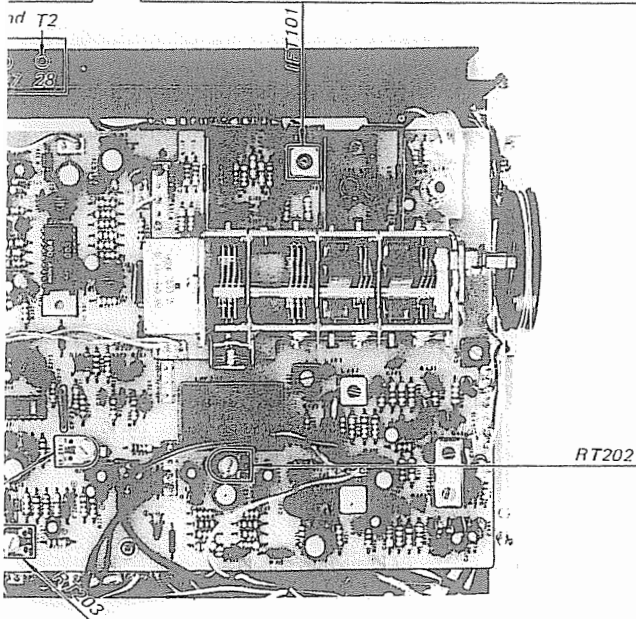

FM STEREO SEPARATION ADJUSTMENT

Setup:

FUNCTION selector: FM

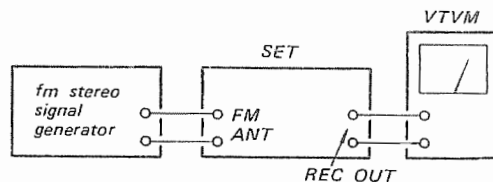

FM Stereo Signal Generator Setting:

Carrier frequency: 98 MHz

Mode: Stereo

Audio (400 Hz) Mode: 67.5 kHz (90%)

Pilot (19 kHz) Mode: 7.5 kHz (10%)

Procedure:

1. Tune the set to 98 MHz.
2. Set the signal generator channel selector to L-CH.
3. Connect the VTVM to the REC OUT "L-CH" of the set and read the output level on the VTVM.
4. Turn the stereo signal generator channel selector from L-CH to R-CH and adjust RT202 for minimum output on the VTVM.

Note: The output level difference between step 3 and step 4 represents the separation.

5. Connect the VTVM to the REC OUT "R-CH" of the set and read the output level on the VTVM.
6. Turn the stereo signal generator channel selector from R-CH to L-CH and adjust RT202 for minimum output on the VTVM.
7. If the separation obtained in step 4 and step 6 differs more than 3 dB in value, readjust RT202 to be less than 3 dB.

MUTING LEVEL ADJUSTMENT

Setup:

FUNCTION selector: FM

MUTING switch: ON

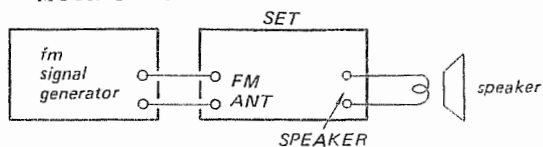

FM Signal Generator Setting:

Carrier frequency: 98 MHz

Modulation: 400 Hz, 75 kHz deviation
(100%)

Procedure:

1. Set the output level of the fm signal generator to 5.6 μ V (15 dB).
2. Adjust R203 for the point that the sound begins to disappear.

MOUNTING DIAGRAM - FRONT-END, FM/AM Boards -
 - Conductor Side -

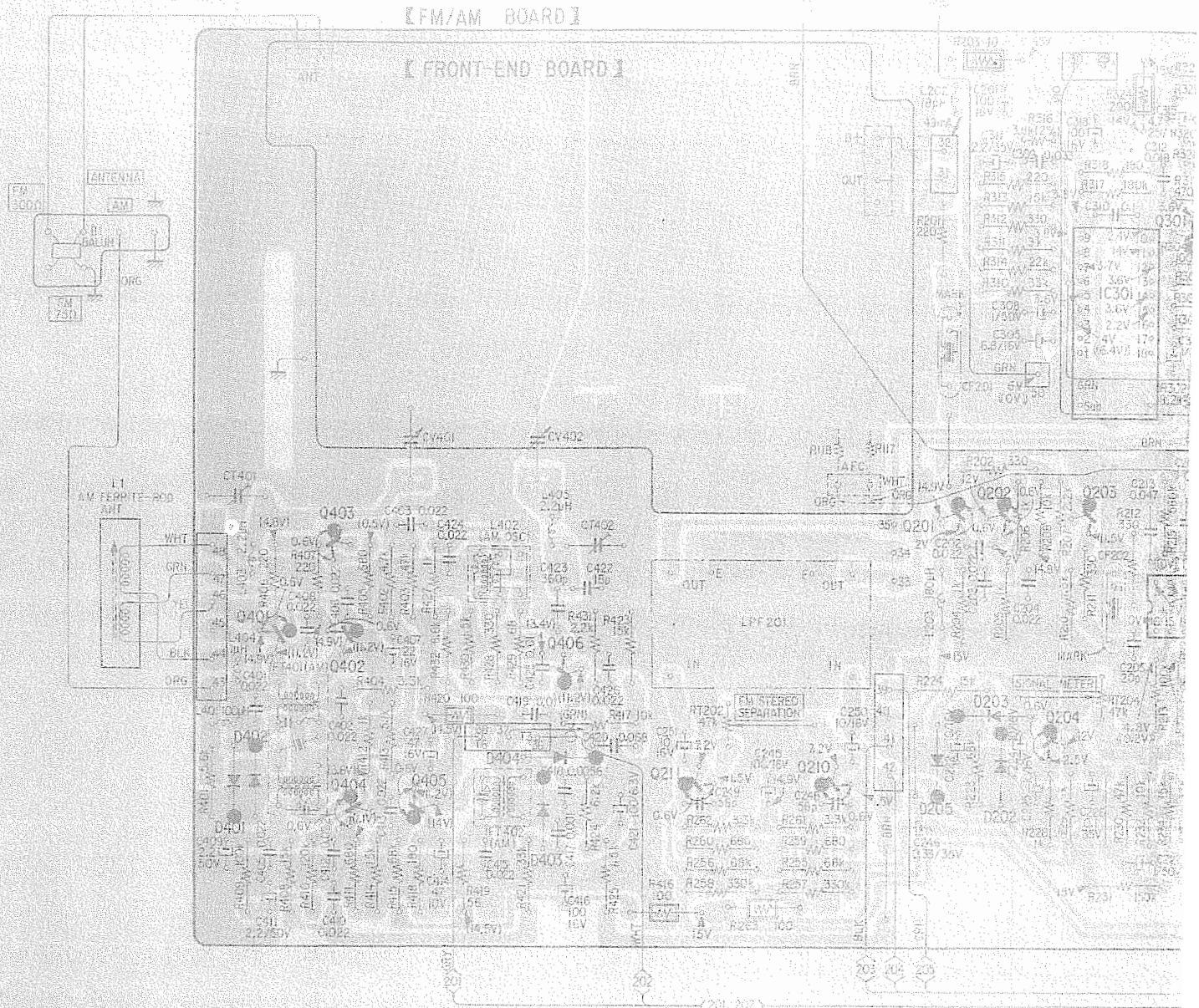

D & IC	401	403	402 404	405		406		211		210		201	202		204	203	IC301	3	
D	401	402				404							203			205		202	

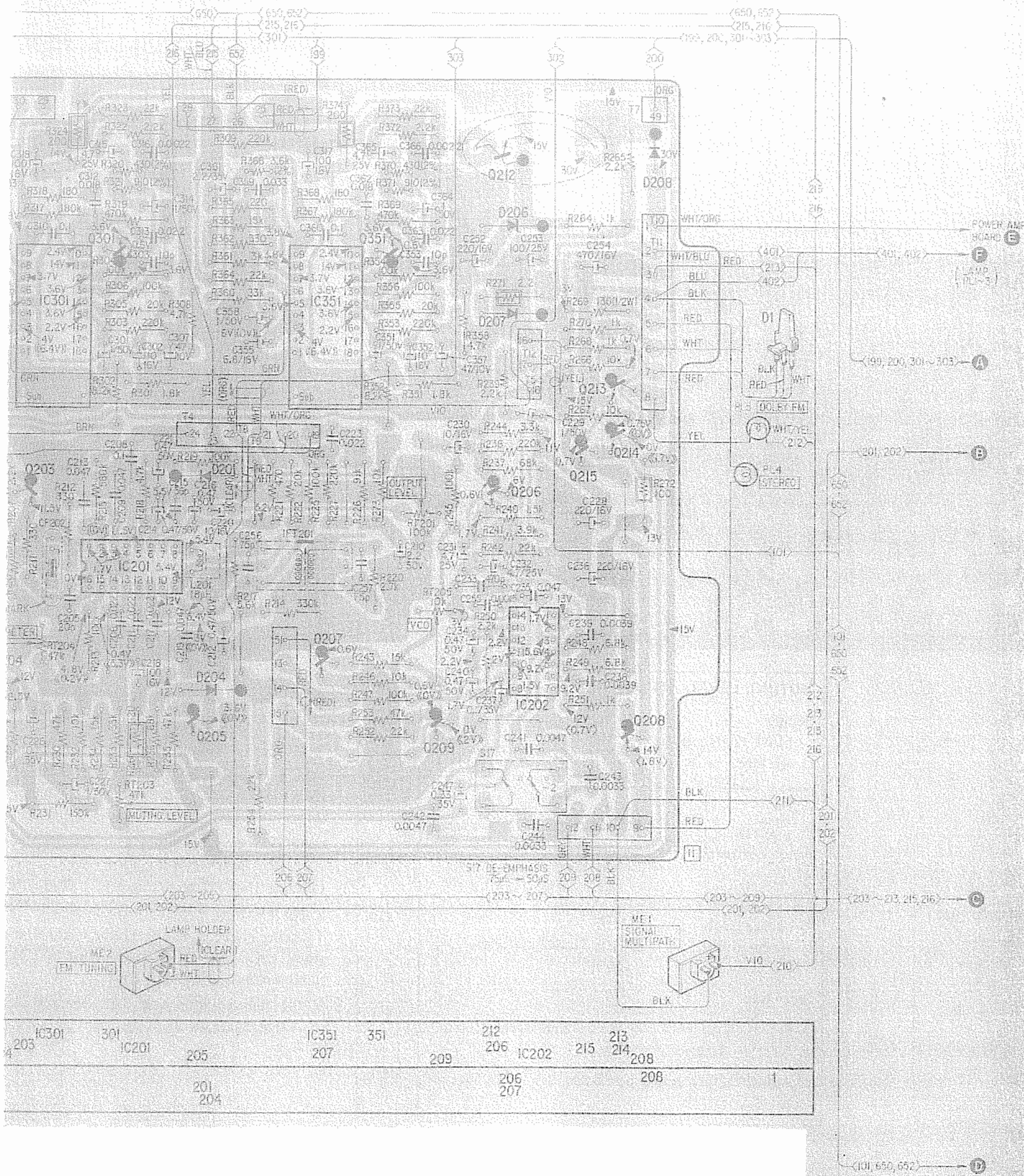

2. UK MODEL AND NEW TYPE OF US, CANADIAN, AEP, PX, MODEL

1) Schematic Diagram

— Front-End, Fm/Am section —
— P 17 —

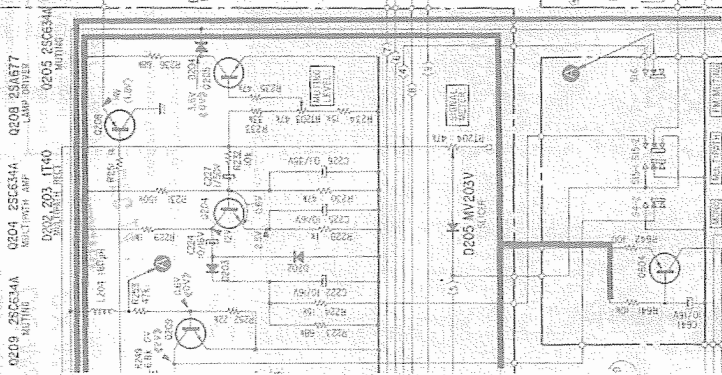

2) Mounting Diagram

— Front-End, Fm/Am Board —
— P 13 —

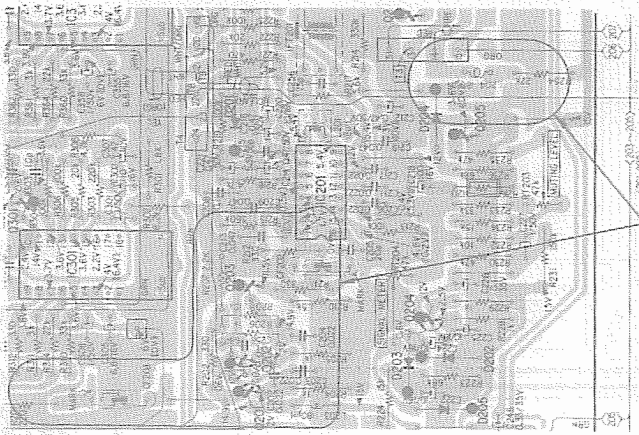

These patterns are changed.

1. FORMER TYPE OF US, CANADIAN, AEP, PX, MGBEL

1) Schematic Diagram

— Front-End, Fm/Am section —
— P 17 —

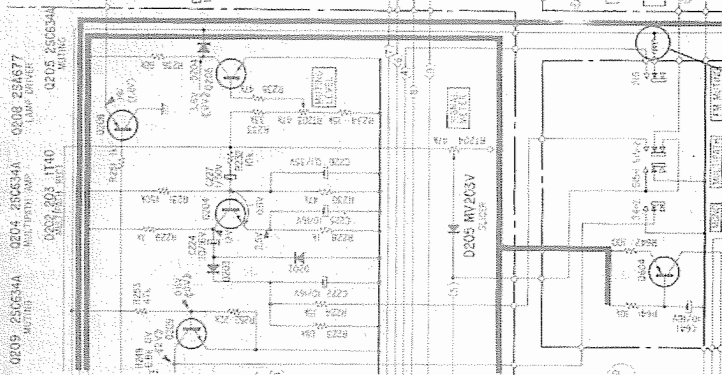

2) Mounting Diagram

— Front-End, Fm/Am Board —
— P 13 —

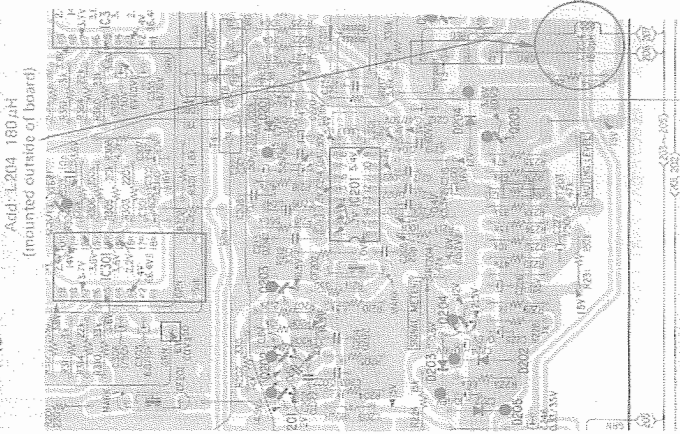

Add: L204 180μH
(mounted outside of board)

3. ELECTRICAL PART LIST

Ref. No. Part No. Description

L204 1-407-172-XX (1) 180μH

Note US model

{ new type: serial No. 801,001 and later
{ former type: serial No. until 801,000

AEP model: { new type: serial No. 500,201 and later
{ former type: serial No. until 500,200

Add: L204 180μH

ELECTRICAL PARTS LIST

Note: The circled letters (A to Z) are applicable for the European model only.

<u>Ref. No.</u>	<u>Part No.</u>	<u>Description</u>	<u>Ref. No.</u>	<u>Part No.</u>	<u>Description</u>
SEMICONDUCTORS					
Transistors					
Q101		(E) 3SK37	Q805		(C) 2SC1670
Q102		(C) 2SK23A	Q931		(E) 2SC1124
Q103, 104		(B) 2SC710	Q932		(D) 2SA706
Q105		(C) 2SK23A	Q933		(C) 2SA678
Q106		(B) 2SC710	ICs		
Q201 ~ 203		(B) 2SC710	IC201		(H) HA1137W
Q204, 205		(B) 2SC945	IC202		(J) HA1156
⇒ Q206		(B) 2SC632A	IC301, 351		(I) CX064
Q207		(B) 2SC945	IC701, 702		(O) SS120A
⇒ Q208		(C) 2SA678	D1-1, 1-2		(H) TX312
Q209		(B) 2SC945	D101		(B) 1S2687
⇒ Q210, 211		(B) 2SC632A	D201		(B) 1T22A
Q212		(D) 2SD291	⇒ D202 ~ 204		(B) 1S1555
Q213 ~ 215		(B) 2SC945	D205		(B) MV203V
⇒ Q301, 351		(B) 2SC632A	D206		(B) EQA01-16R
Q401 ~ 404		(B) 2SC403C	D207, 208		(B) 10E2
Q405, 406		(B) 2SC710	⇒ D401, 402		(B) 1S1555
Q501, 551		(B) 2SC1636	D403, 404		(B) 1T22A
Q502, 552)		(B) 2SA705	D701		(B) VD1221
Q503, 553)			D702 ~ 705)		(B) 1S1555
Q601, 651		(B) 2SC1636	D752 ~ 755)		
Q602, 652		(B) 2SA705	D801 ~ 803		(B) 1S1555
Q603, 653		(B) 2SC632A	D804		(B) 1T243M
Q604		(C) 2SA678	D805, 806		(B) 1S1555
Q701, 751		(D) 2SA884	D901		(F) S5151
Q702, 752		(B) 2SA705	D902		(F) S5151R
Q703, 753		(C) 2SA896	D911, 912		(B) 10E2
Q704, 754		(C) 2SC1811	D913, 914		(B) 10D2
⇒ Q705, 755		(C) 2SA678	⇒ D931, 932		(B) EQB01-21
⇒ Q706, 756)		(B) 2SC634A	THERMISTOR		
Q707, 757)			Pth801, 851 1-800-427-21		(B) Positive
⇒ Q708, 758		(C) 2SA678			
⇒ Q801 ~ 803		(C) 2SA678			
⇒ Q804		(B) 2SC634A			

⇒ : Due to replacement parts, the descriptions are different from the diagrams.

SCHEMATIC DIAGRAM - FRONT-END, FM/AM Section -

[FM/AM BOARD]

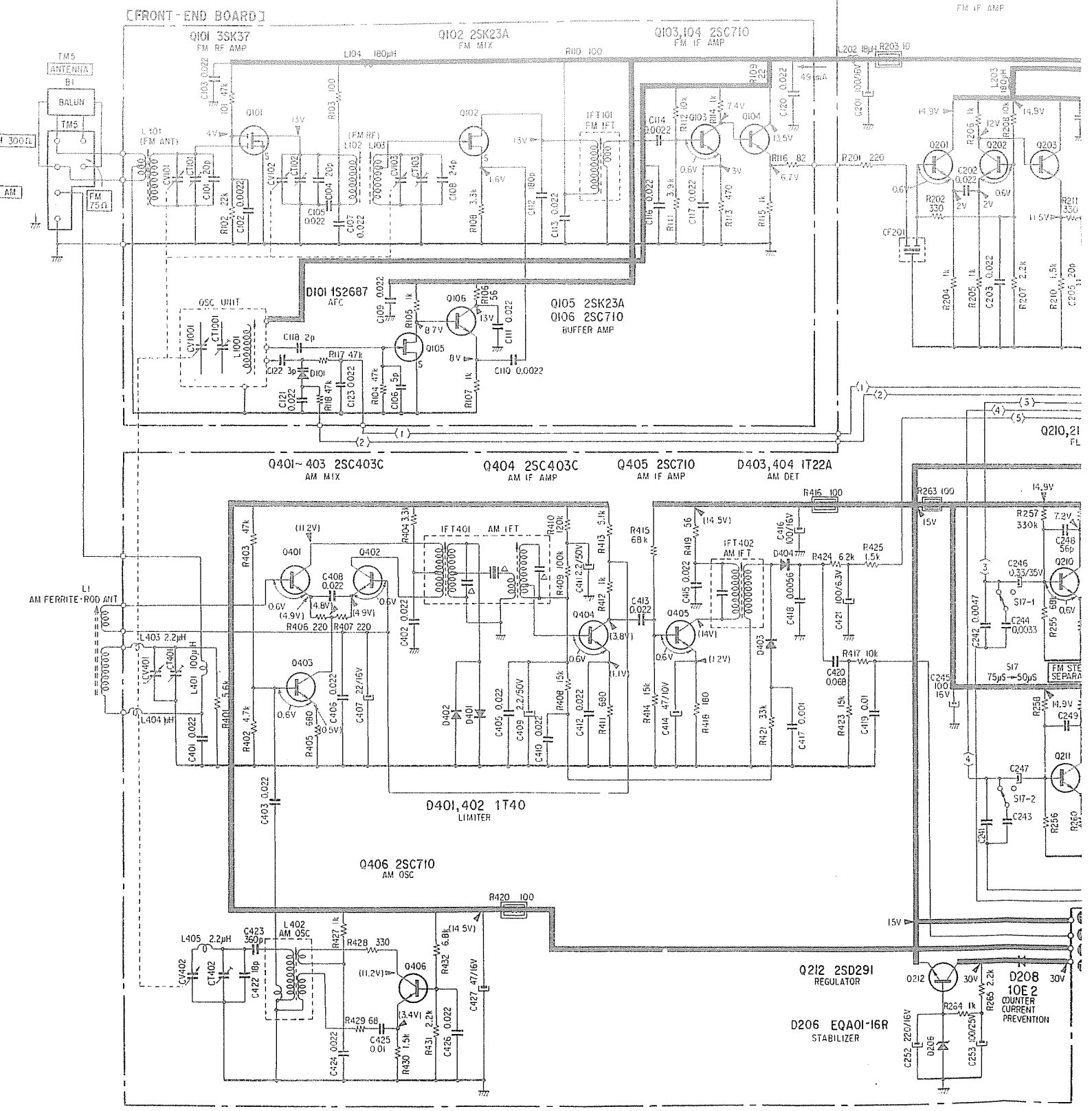

IC201 HA1137W
METER DRIVER
MUTING/FM IF AMP
DISCRIMINATOR

D201 1T22A
MUTING

Q206 2SC632A
FLAT AMP

Q207 2SC634A
VCO STOPPER

IC202 HA1156
MPX DECODER

Q209 2SC634A
MUTING

Q204 2SC634A
MULTIPATH AMP

Q208 2
LAMP

D202, 203 1T40
MULTIPATH RECT

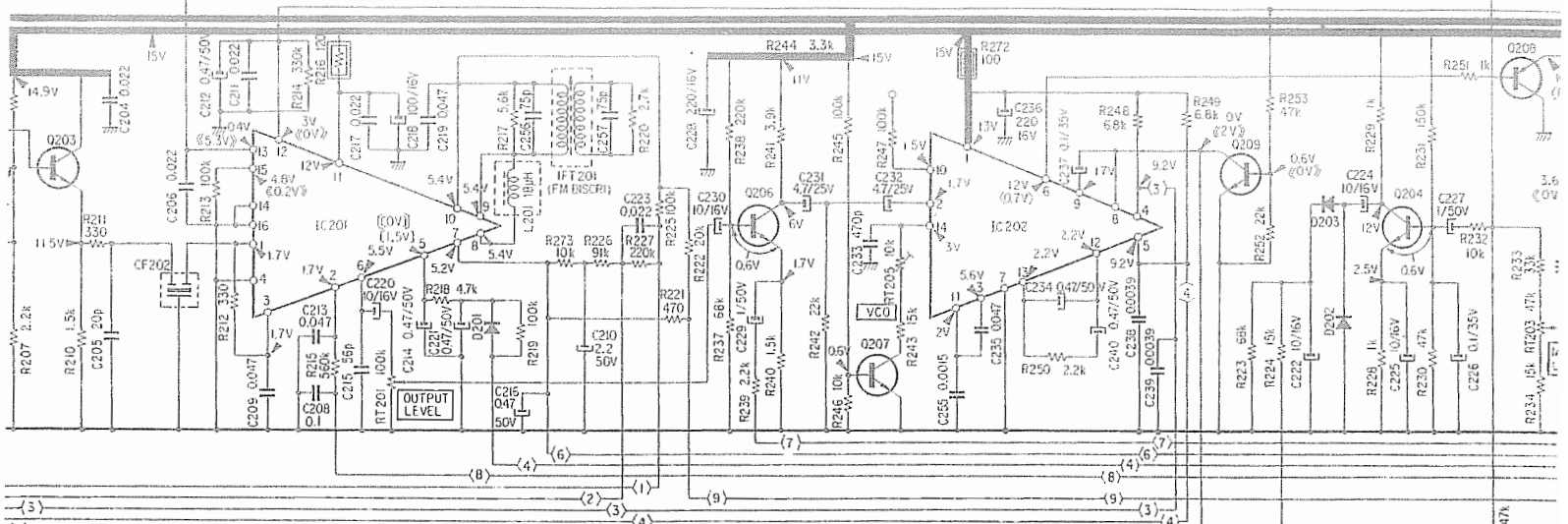

Q210, 211 2SC632A
FLAT AMP

IC301, 351 CX064
DOLBY B

Q301, 351 2SC632A
BUFFER AMP

D205 MV203V
SLICER

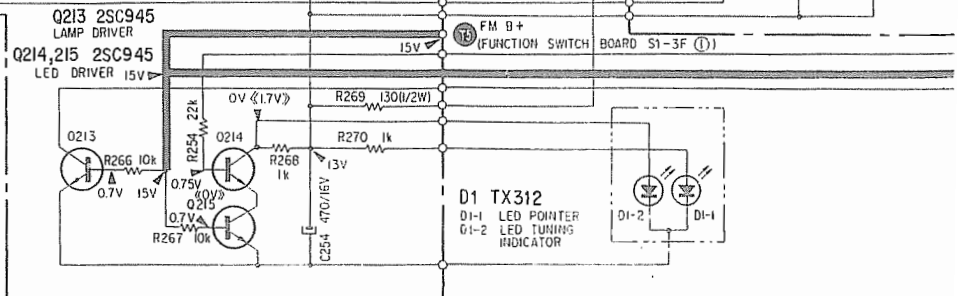
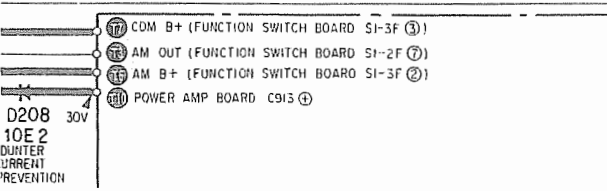
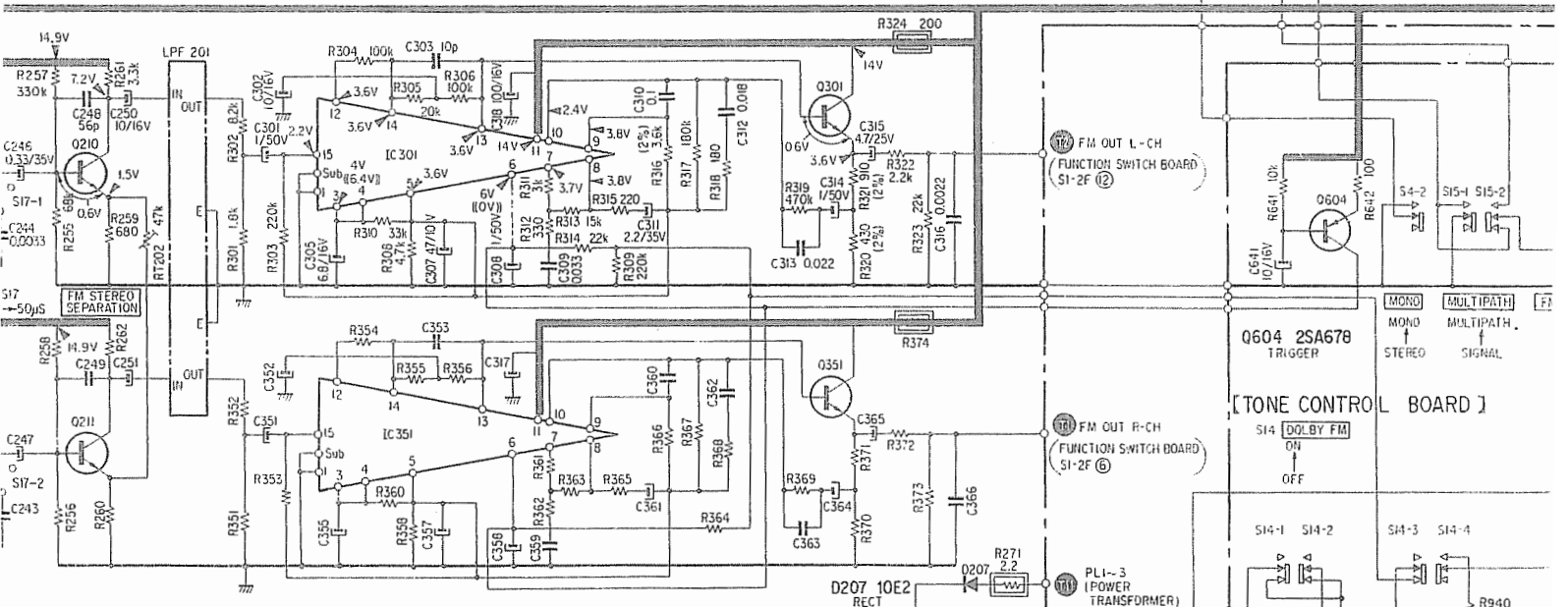

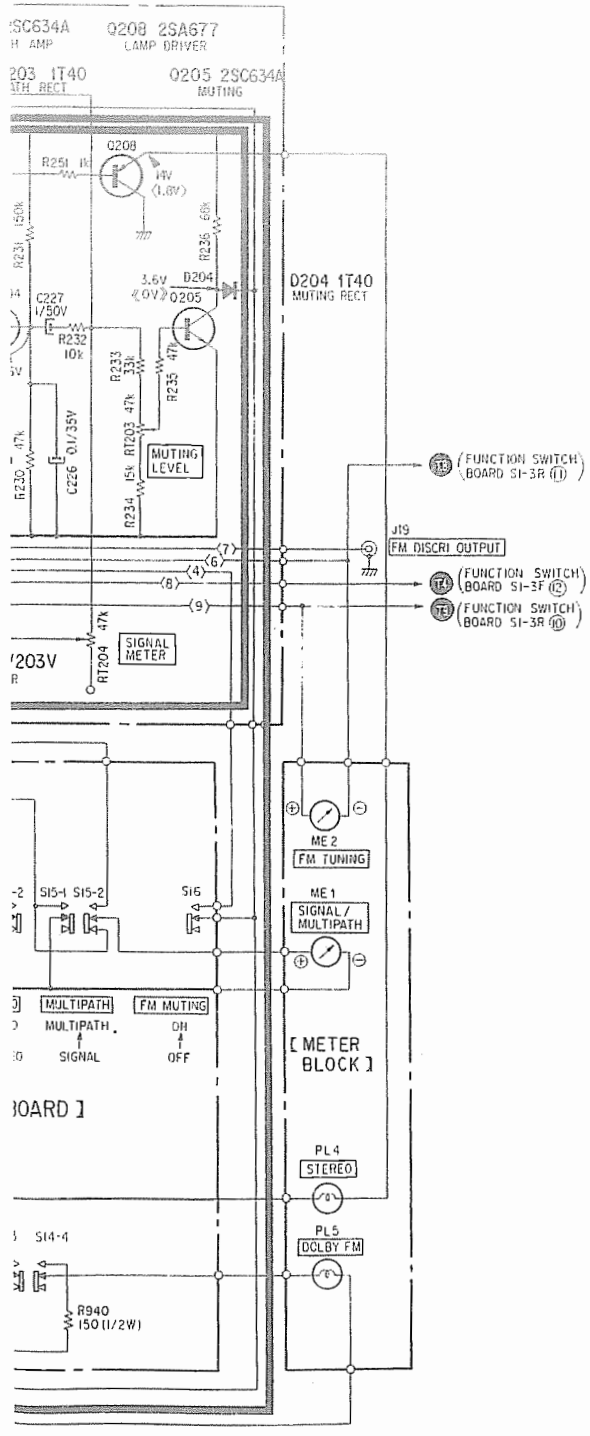

Note:

- All capacitors are in μF unless otherwise noted. 50 or less working volts are omitted except for electrolytic type. $\mu = \mu\text{M}\text{F}$.
- All resistors are in Ω , $\frac{1}{2}\text{W}$, unless otherwise noted. $k = 1,000$ $M = 1,000k$
- indicates nonflammable resistor
- indicates internal components
- indicates chassis ground
- (2%) of resistor indicates the tolerance ($\pm 2\%$).
- indicates B+ circuit
- Voltages are DC with respect to ground unless otherwise noted. Readings are taken under no-signal conditions with a VOM ($20k\Omega/V$).
- $\ll \gg$: FM (Tuned in FM signal) $< >$: FM STEREO
- (()): DOLBY FM (S14) [()] : MUTING (S16) (Tuned in FM signal) — ON
- [()] : MUTING (S16) (no signal input) () : FUNCTION (S1) — AM
- no mark: FUNCTION (S1) — FM
- Voltage variations may be noted due to normal production tolerances.
- Voltage between base and emitter are measured with 2.5V range.
- Switch Mode:

Ref. No.	Switch	Position
S4	MONO	STEREO
S15	MULTIPATH	SIGNAL
S16	FM MUTING	OFF
S17	DE-EMPHASIS	$75\mu\text{s}$

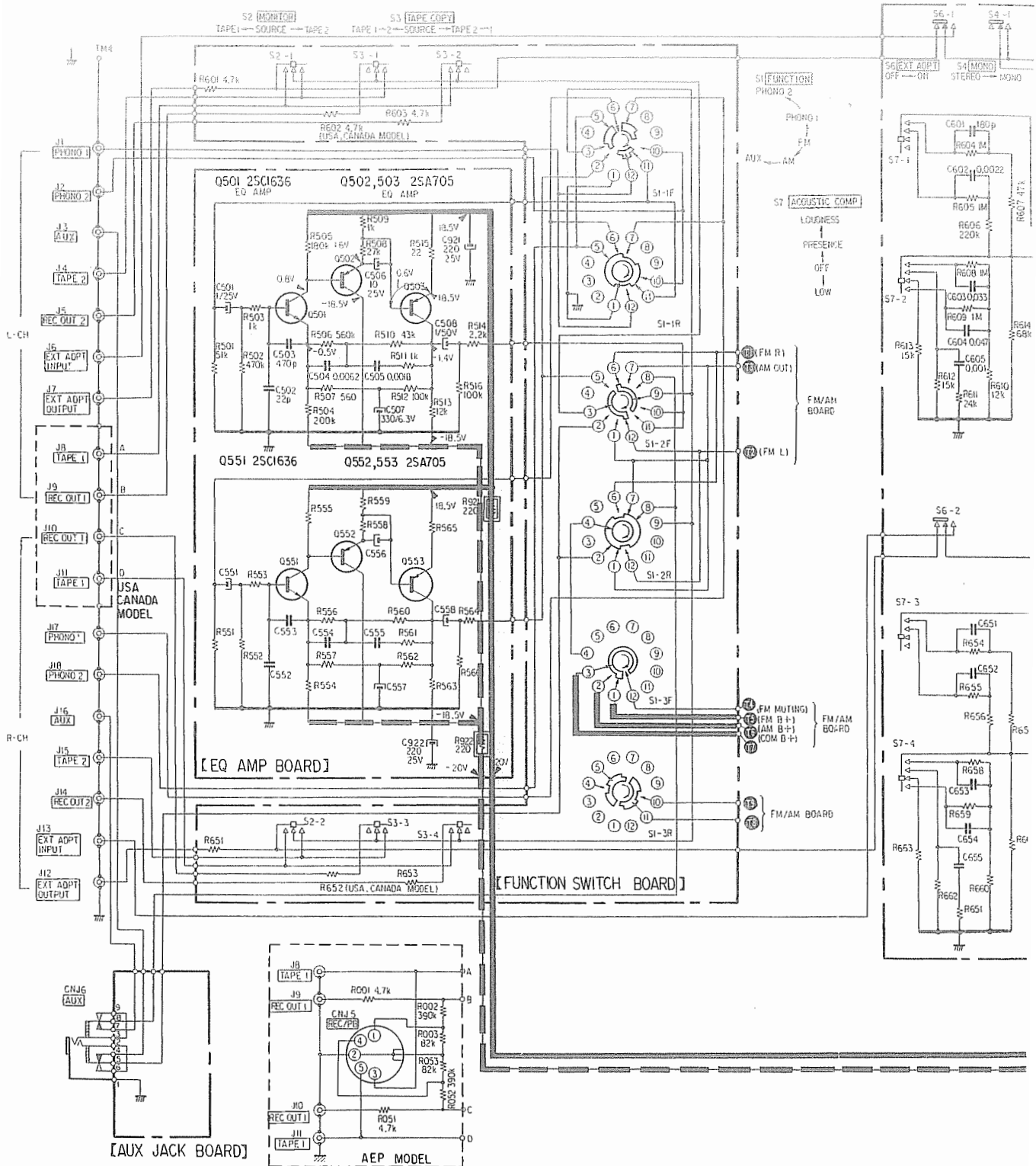

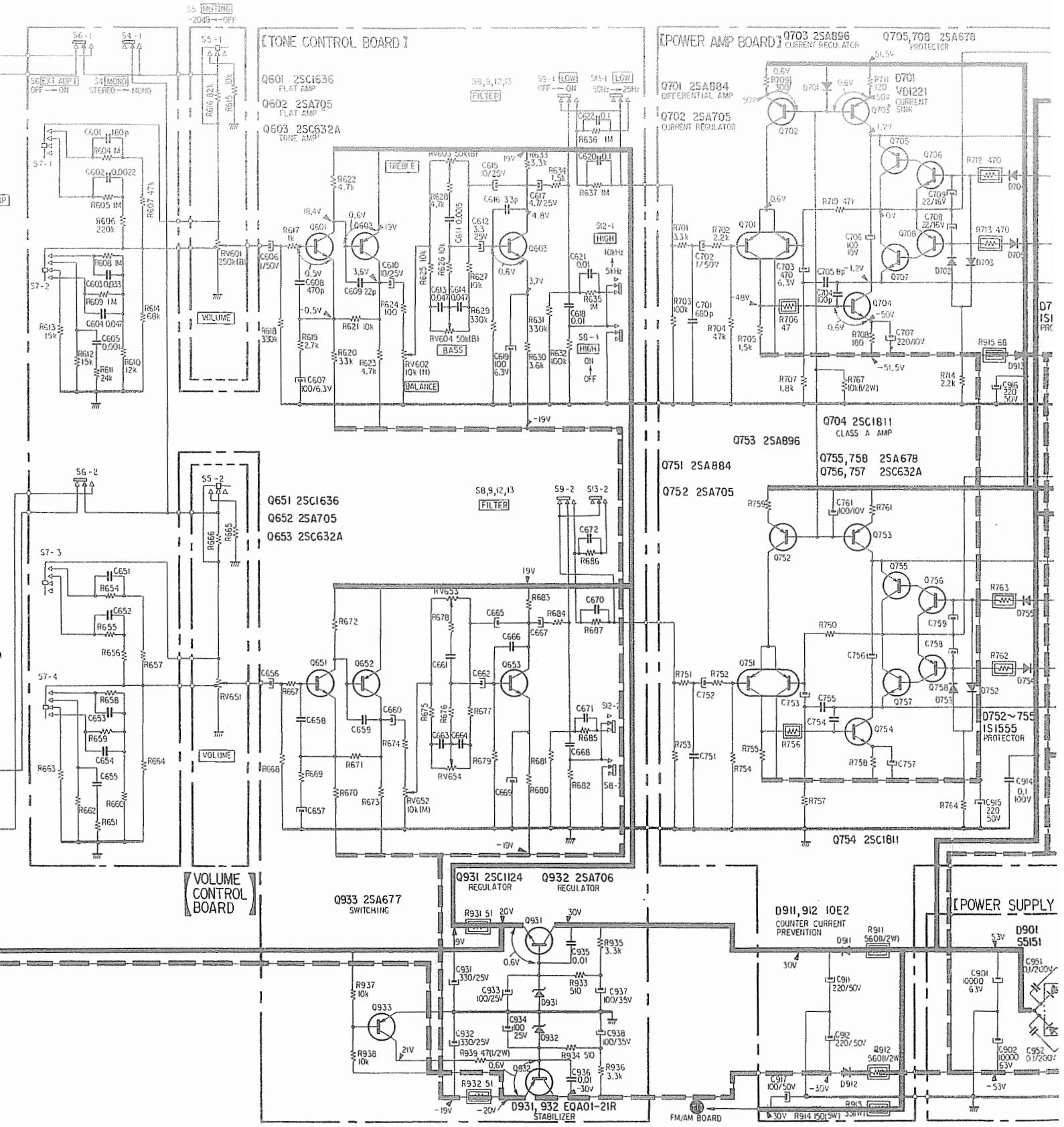

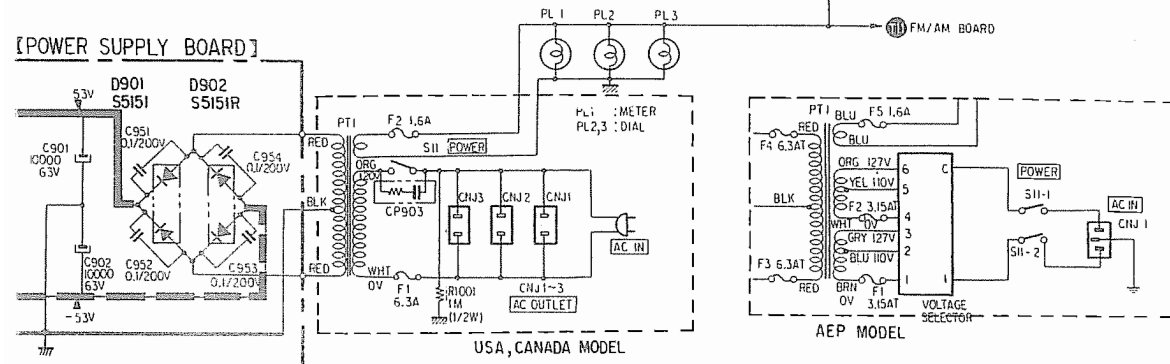
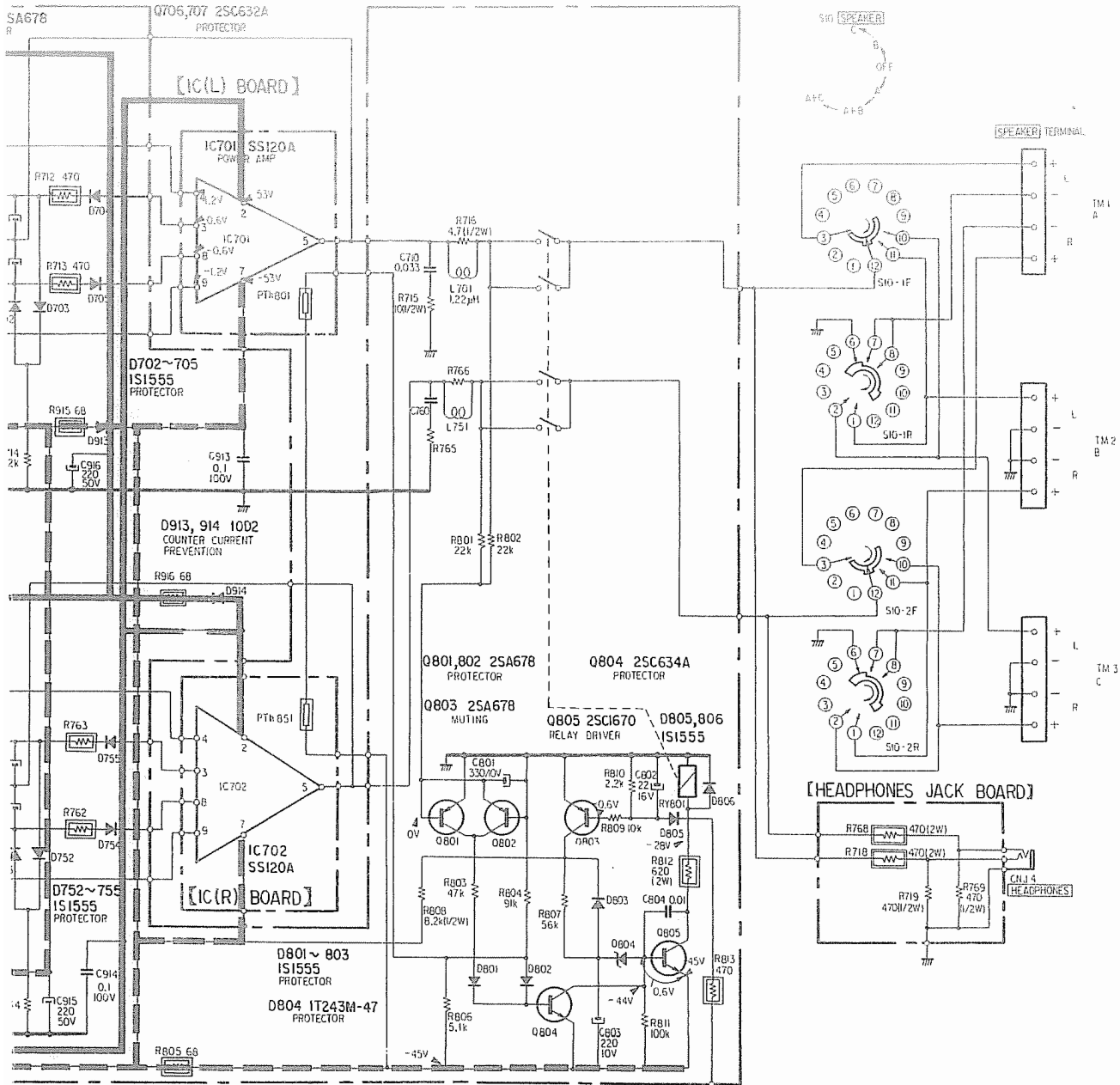

Sony STR-6800SD

Note: The circled letters (A to Z) are applicable for the European model only.

Ref. No.	Part No.	Description
COILS		
L1	1-401-635-21	(G) AM Ferrite-rod Antenna
L101	1-401-662-00	(B) FM Ant
L102	1-425-925-00	(B) FM RF
L103	1-425-926-00	(B) FM RF
L104	1-407-172-XX	(A) Microinductor, 180 μ H
L201	1-459-152-00	(B) 18 μ H
L202	1-407-160-XX	(A) Microinductor, 18 μ H
L203	1-407-172-XX	(A) Microinductor, 180 μ H
L401	1-407-169-XX	(A) Microinductor, 100 μ H
L402	1-405-656-00	(B) AM Osc
L403	1-407-182-XX	(A) Microinductor, 2.2 μ H
L404	1-407-178-XX	(A) Microinductor, 1 μ H
L405	1-407-182-XX	(A) Microinductor, 2.2 μ H
L701, 751	1-420-838-00	(A) 1.2 μ H
TRANSFORMERS		
B1	1-417-014-31	(B) Balun
IFT101	1-403-295-12	(B) FM IFT
IFT201	1-404-029-00	(C) FM Discriminator
IFT401	1-404-014-11	(D) AM IFT (USA, Canada models)
	1-404-014-21	(D) AM IFT (AEP model)
IFT402	1-403-149-00	(B) AM IFT
PT1	1-442-596-00	(S) Power (USA model)
	1-442-643-00	(S) Power (AEP model)
	1-442-644-00	(S) Power (Canada model)
FILTERS		
CF201, 202	1-527-248-XX	(H) Ceramic
LPF201	1-231-219-00	(D) Low-pass
CAPACITORS		

All capacitors are in μ F and of electrolytic unless otherwise noted. .50 and/or less working voltages are not indicated except for electrolytic type. (p = μ μ F)

Ref. No.	Part No.	Description
C101	1-101-981-11	(A) 20 p ceramic
C102	1-102-257-11	(A) 0.0022 ceramic
C103	1-101-924-11	(A) 0.022 ceramic
C104	1-101-981-11	(A) 20 p ceramic
C105	1-101-924-11	(A) 0.022 ceramic
C106	1-102-864-11	(A) 5 p ceramic
C107	1-101-924-11	(A) 0.022 ceramic
C108	1-102-642-11	(A) 24 p ceramic
C109	1-101-924-11	(A) 0.022 ceramic
C110	1-101-919-11	(A) 0.0022 ceramic
C111	1-101-924-11	(A) 0.022 ceramic
C112	1-102-848-11	(A) 180 p ceramic
C113	1-101-924-11	(A) 0.022 ceramic
C114	1-101-919-11	(A) 0.0022 ceramic
C116, 117	1-101-924-11	(A) 0.022 ceramic
C118	1-102-502-11	(A) 2 p ceramic
C119	(A)	
C120, 121	1-101-924-11	(A) 0.022 ceramic
C122	1-102-503-11	(A) 3 p ceramic
C123	1-101-924-11	(A) 0.022 ceramic
C201	1-121-415-11	(B) 100 16 V
C202 ~ 204	1-101-924-11	(A) 0.022 ceramic
C205	1-101-974-11	(A) 20 p ceramic
C206	1-101-924-11	(A) 0.022 ceramic
C208	1-108-251-12	(B) 0.1 mylar
C209	1-101-925-11	(A) 0.047 ceramic
C210	1-121-651-11	(A) 10 16 V
C211	1-101-924-11	(A) 0.022 ceramic
C212	1-121-726-11	(A) 0.47 50 V
C213	1-101-925-11	(A) 0.047 ceramic
C214	1-121-726-11	(A) 0.47 50 V
C215	1-101-884-11	(A) 56 p ceramic
C216	1-121-726-11	(A) 0.47 50 V
C217	1-101-924-11	(A) 0.022 ceramic
C218	1-121-415-11	(B) 100 16 V
C219	1-101-925-11	(A) 0.047 ceramic
C220	1-121-651-11	(A) 10 16 V
C221	1-121-726-11	(A) 0.47 50 V
C222	1-121-651-11	(A) 10 16 V

Note: The circled letters (A to Z) are applicable for the European model only.

<u>Ref. No.</u>	<u>Part No.</u>	<u>Description</u>	
C223	1-101-924-11 (A) 0.022	ceramic	
C224, 225	1-121-651-11 (A) 10 16 V		
C226	1-131-209-11 (B) 0.1 35 V	tantalum	
C227	1-121-391-11 (A) 1 50 V		
C228	1-123-068-11 (B) 220 16 V		
C229	1-121-391-11 (A) 1 50 V		
C230	1-121-651-11 (A) 10 16 V		
C231, 232	1-121-395-11 (A) 4.7 25 V		
C233	1-103-717-11 (A) 470 p	polystyrol	
C234	1-121-726-11 (A) 0.47 50 V		
C235	1-108-246-12 (A) 0.047	mylar	
C236	1-123-068-11 (B) 220 16 V		
C237	1-131-209-11 (B) 0.1 35 V	tantalum	
C238, 239	1-108-569-12 (B) 0.0039	mylar	
C240	1-121-726-11 (A) 0.47 50 V		
C241, 242	1-108-571-12 (A) 0.0047	mylar	
C243, 244	1-108-567-12 (A) 0.0033	mylar	
C245	1-121-415-11 (B) 100 16 V		
C246, 247	1-131-212-11 (B) 0.33 35 V	tantalum	
C248, 249	1-101-884-11 (A) 56 p	ceramic	
C250, 251	1-121-651-11 (A) 10 16 V		
C252	1-123-068-11 (B) 220 16 V		
C253	1-121-935-11 (B) 100 25 V		
C254	1-121-939-11 (B) 470 16 V		
C255	1-108-228-12 (A) 0.0015	mylar	
C256, 257	1-102-732-11 (A) 75 p	ceramic	
C301, 351	1-121-912-11 (A) 1 50 V		
C302, 352	1-121-651-11 (A) 10 16 V		
C303, 353	1-102-947-11 (A) 10 p	ceramic	
C305, 355	1-131-198-11 (B) 6.8 16 V	tantalum	
C307, 357	1-121-352-11 (A) 47 10 V		
C308, 358	1-121-912-11 (A) 1 50 V		
C309, 359	1-108-244-12 (A) 0.033	mylar	
C310, 360	1-108-603-12 (B) 0.1	mylar	
C311, 361	1-131-217-11 (B) 2.2 35 V	tantalum	
C312, 362	1-108-585-12 (B) 0.018	mylar	
C313, 363	1-108-587-12 (A) 0.022	mylar	

<u>Ref. No.</u>	<u>Part No.</u>	<u>Description</u>	
C314, 364	1-121-912-11 (A) 1 50 V		
C315, 365	1-121-395-11 (A) 4.7 25 V		
C316, 366	1-108-230-12 (A) 0.0022	mylar	
C317, 318	1-121-415-11 (B) 100 16 V		
C401 ~ 403	1-101-924-11 (A) 0.022	ceramic	
C405, 406	1-101-924-11 (A) 0.022	ceramic	
C407	1-121-479-11 (A) 22 16 V		
C408	1-101-924-11 (A) 0.022	ceramic	
C409	1-121-450-11 (A) 2.2 50 V		
C410	1-101-924-11 (A) 0.022	ceramic	
C411	1-121-450-11 (A) 2.2 50 V		
C412, 413	1-101-924-11 (A) 0.022	ceramic	
C414	1-121-352-11 (A) 47 10 V		
C415	1-101-924-11 (A) 0.022	ceramic	
C416	1-121-415-11 (B) 100 16 V		
C417	1-108-227-12 (A) 0.001	mylar	
C418	1-108-355-12 (A) 0.0056	mylar	
C419	1-108-239-12 (A) 0.01	mylar	
C420	1-108-249-12 (A) 0.068	mylar	
C421	1-121-413-11 (A) 100 6.3 V		
C422	1-102-953-11 (A) 18 p	ceramic	
C423	1-103-714-11 (A) 360 p	polystyrol	
C424	1-101-924-11 (A) 0.022	ceramic	
C425	1-108-239-12 (A) 0.01	mylar	
C426	1-101-924-11 (A) 0.022	ceramic	
C427	1-121-409-11 (A) 47 16 V		
C501, 551	1-131-236-11 (B) 1 25 V	tantalum	
C502, 552	1-102-959-11 (A) 22 p	ceramic	
C503, 553	1-102-114-11 (A) 470 p	ceramic	
C504, 554	1-108-574-12 (A) 0.0062	mylar	
C505, 555	1-108-561-12 (B) 0.0018	mylar	
C506, 556	1-121-398-11 (A) 10 25 V		
C507, 557	1-121-751-11 (B) 330 6.3 V		
C508, 558	1-121-912-11 (A) 1 50 V		
C601, 651	1-102-976-11 (A) 180 p	ceramic	
C602, 652	1-108-230-12 (A) 0.0022	mylar	
C603, 653	1-108-244-12 (A) 0.033	mylar	
C604, 654	1-108-246-12 (A) 0.047	mylar	

4-3. MOUNTING DIAGRAM - AUDIO Amplifier Boards -
 Conductor Side

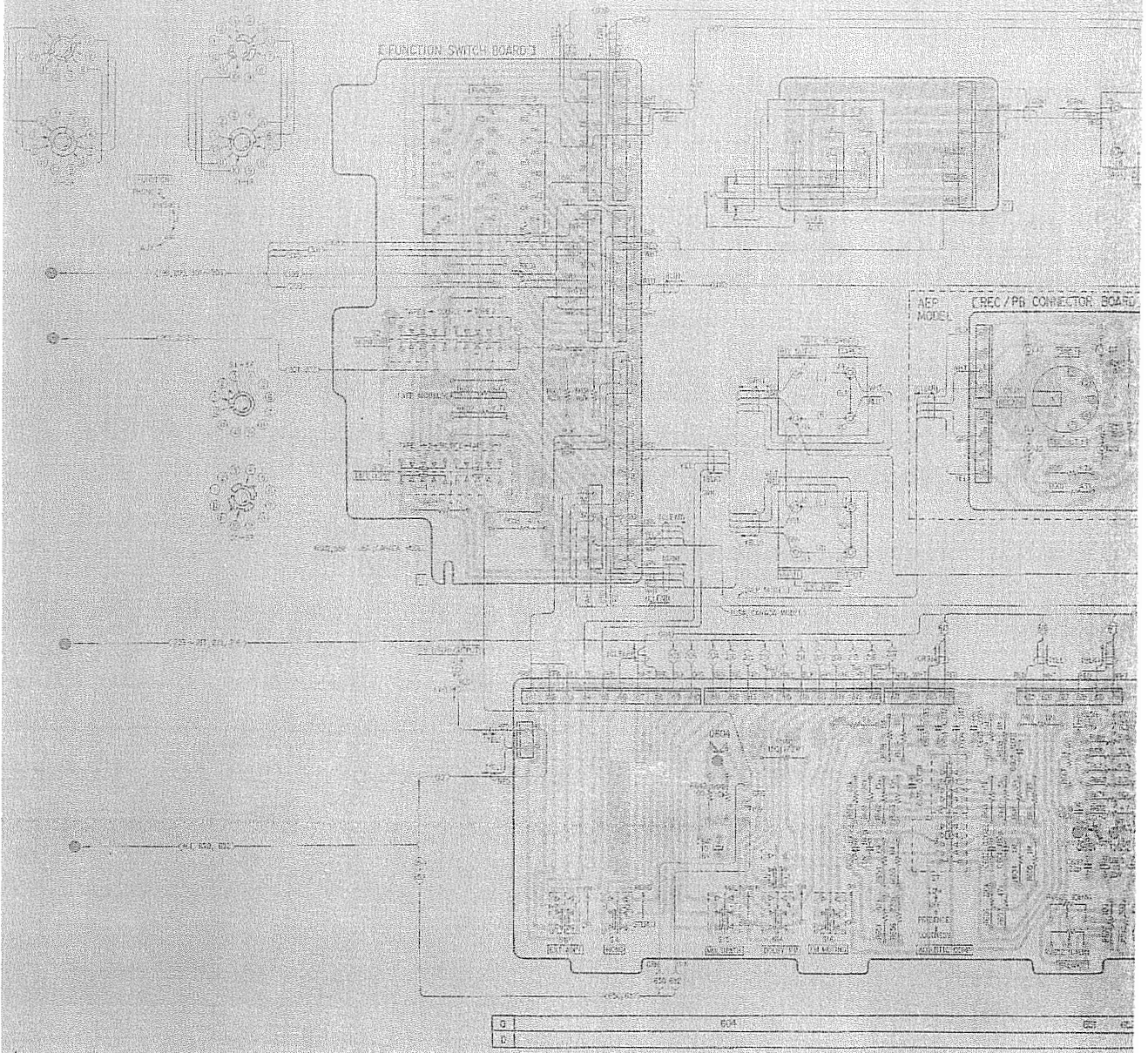

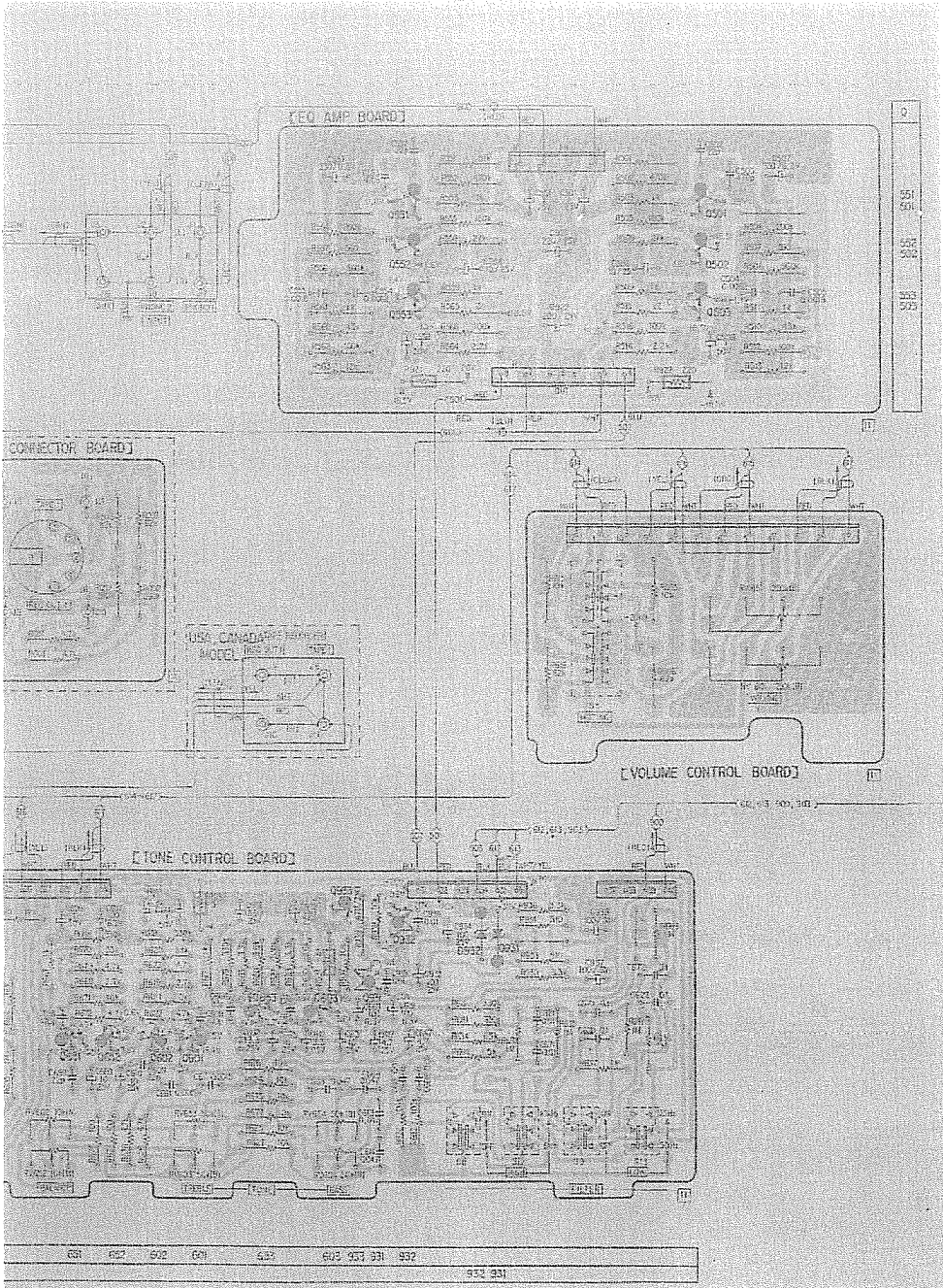

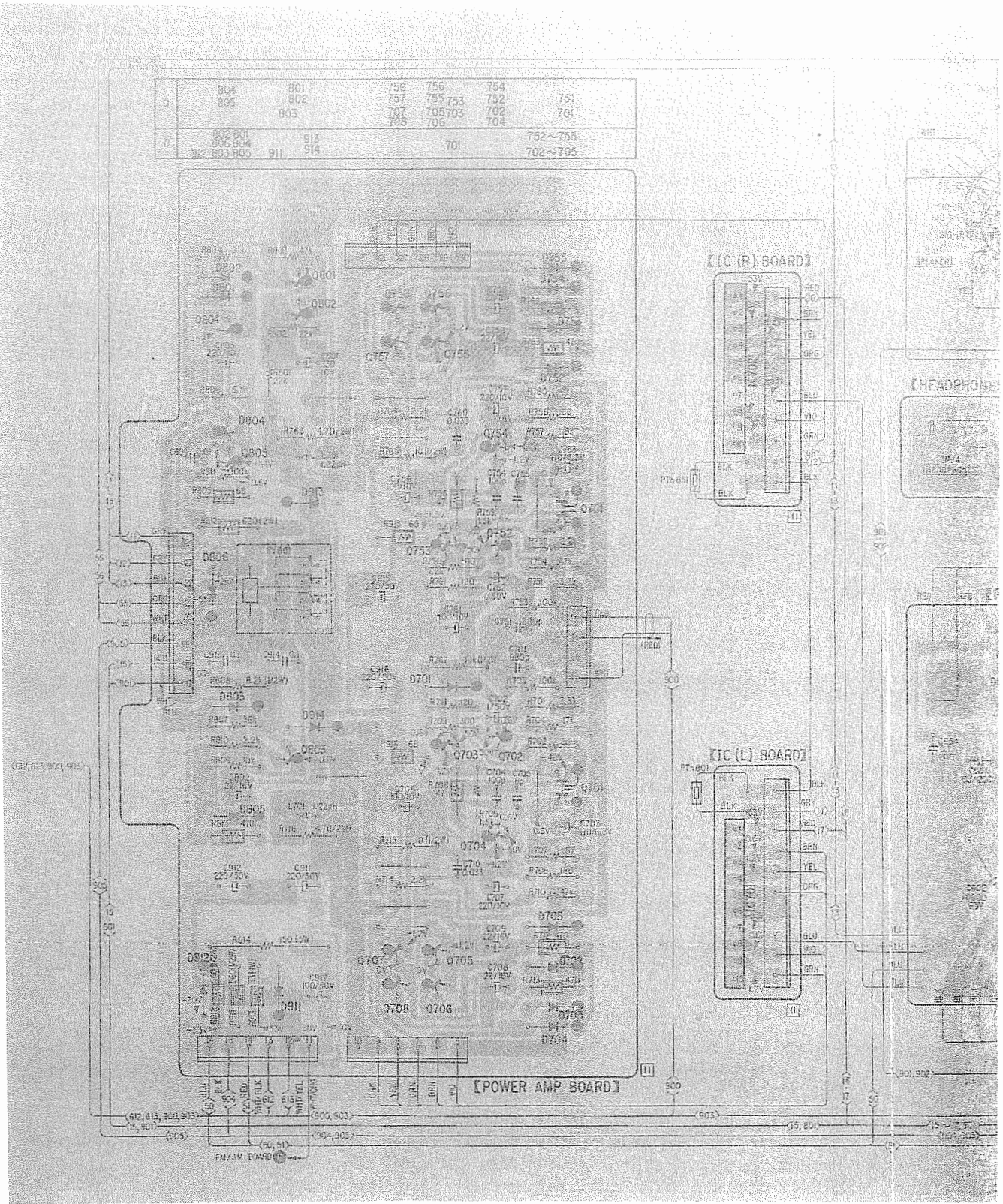

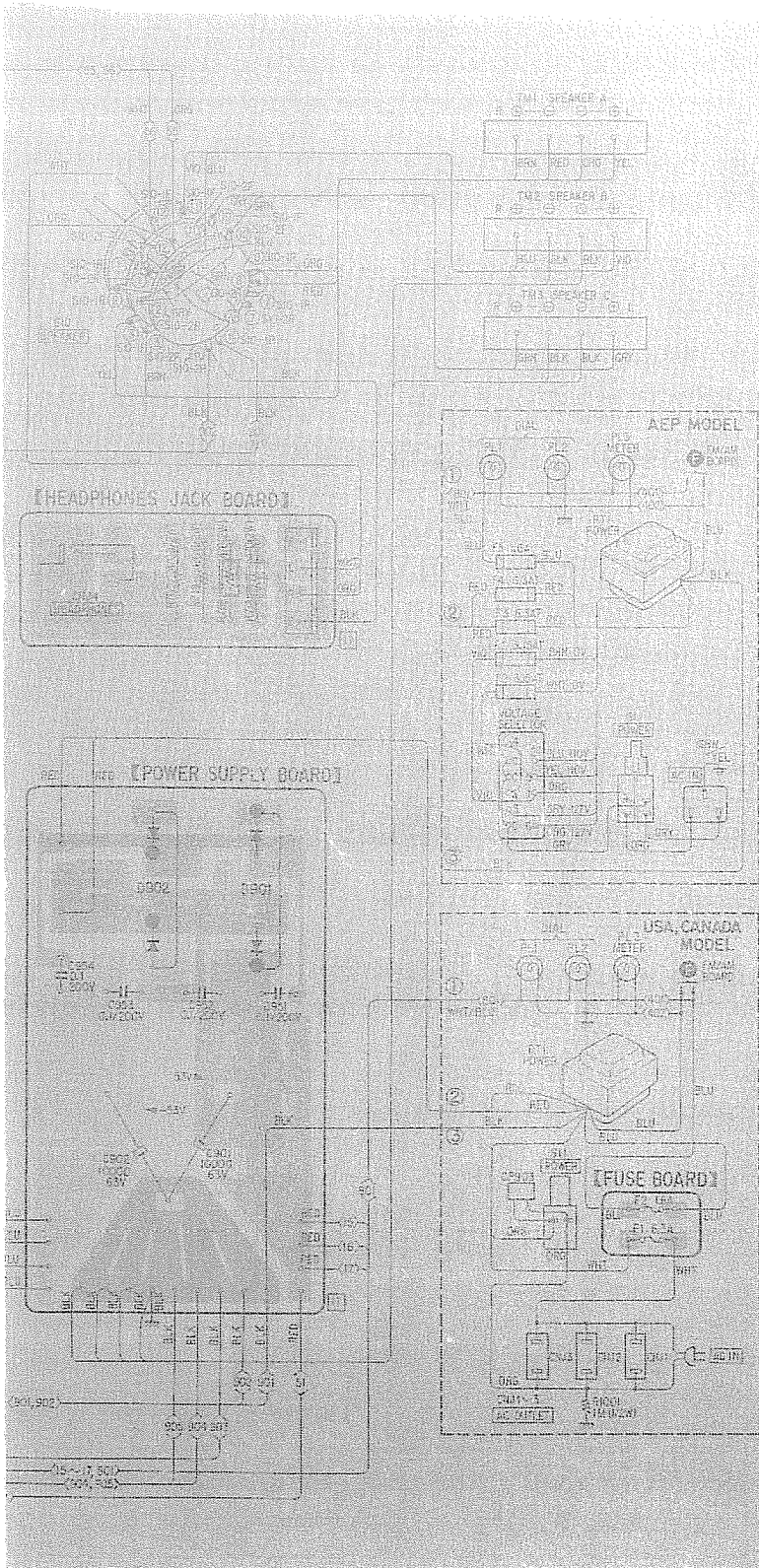

Q501, 551: 2SC1636
 Q601, 651: 2SC1636
 Q603, 653: 2SC1636
 Q706, 756: 2SC632A
 Q707, 757: 2SC632A
 Q804: 2SC634A

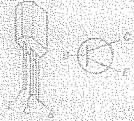

D701: VD1221



D702 ~ 705, 752 ~ 755: 1S1555
 D801 ~ 803, 805, 806: 1S1555
 D911, 912: 10E2



Q502, 503, 602, 652: 2SA705
 Q552, 553, 702, 752: 2SA705
 Q705, 755, 604, 708: 2SA678
 Q758, 801 ~ 803: 2SA678
 Q933: 2SA677

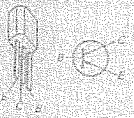

D804: 1T243M



Q701, 751: 2SA884

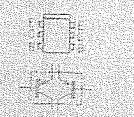

D902: S5151R

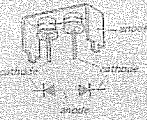

Q703, 753: 2SA896

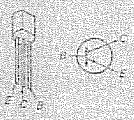

D901: S5151

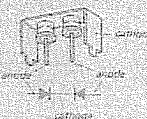

Q704, 754: 2SC1811
 Q805: 2SC1670

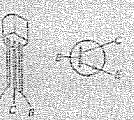

D913, 914: 10D2



Q931: 2SC1124

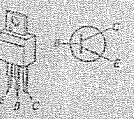

D931, 932: EQA01-21R



Q932: 2SA706

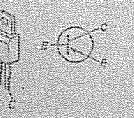

IC701, 702: SS120A

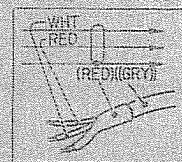
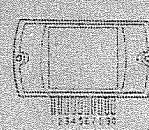

Note:

- : B+ pattern
- : B- pattern
- : nonflammable resistor