

YAMAHA

CR820

AM/FM Stereo Receiver

Owner's Manual

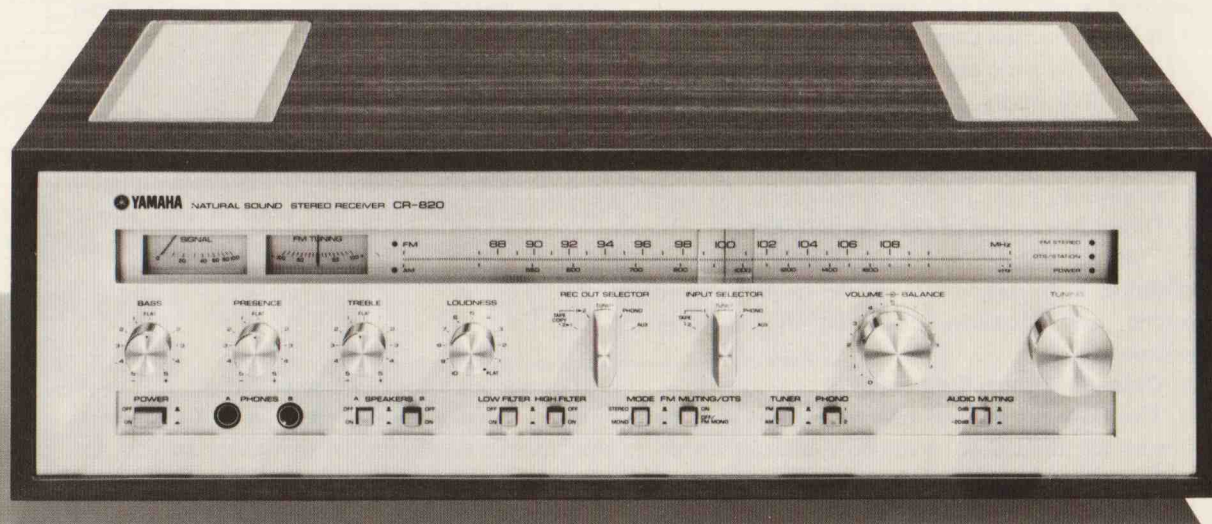

CR-820

CONNECTION DIAGRAM

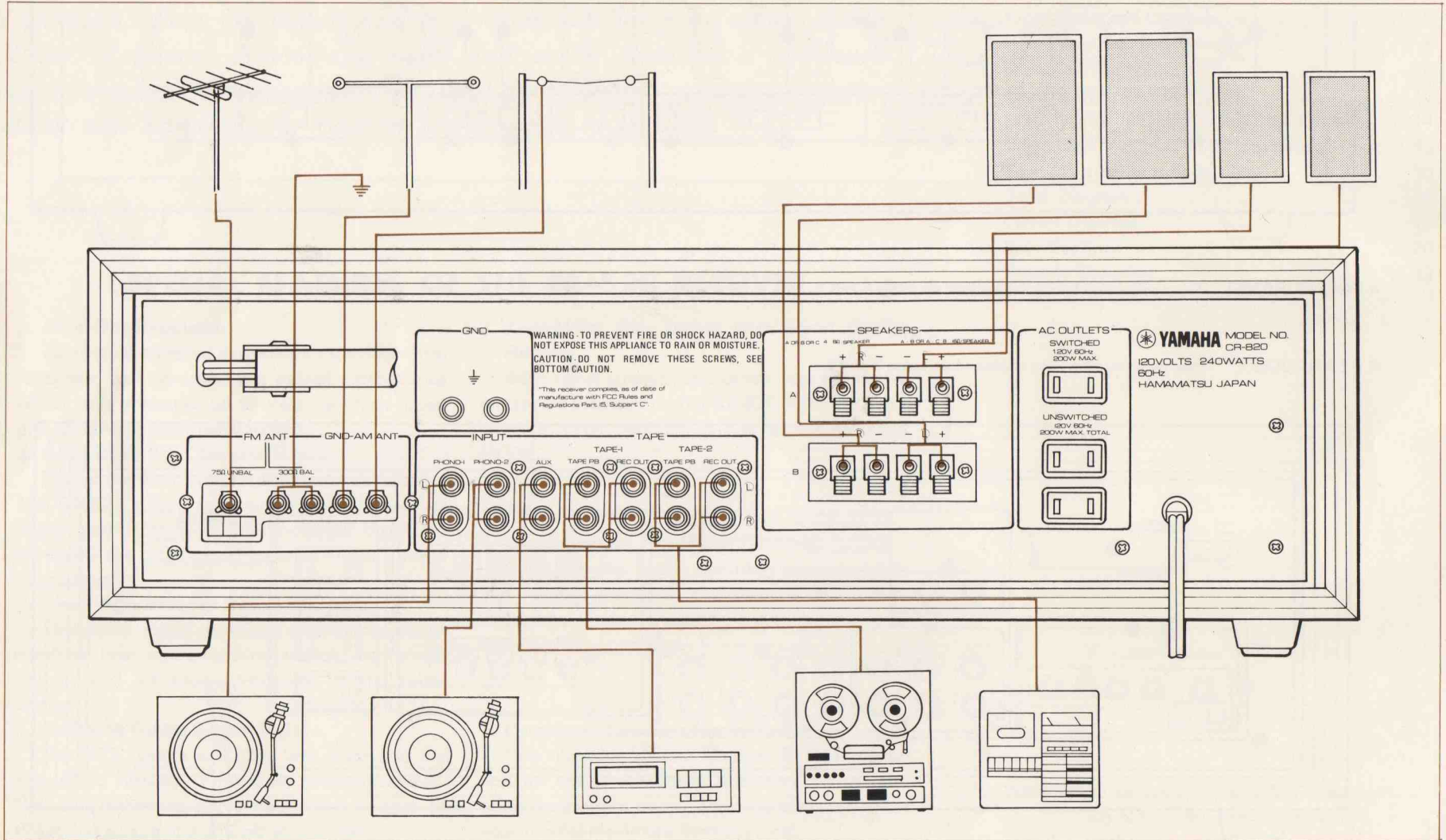

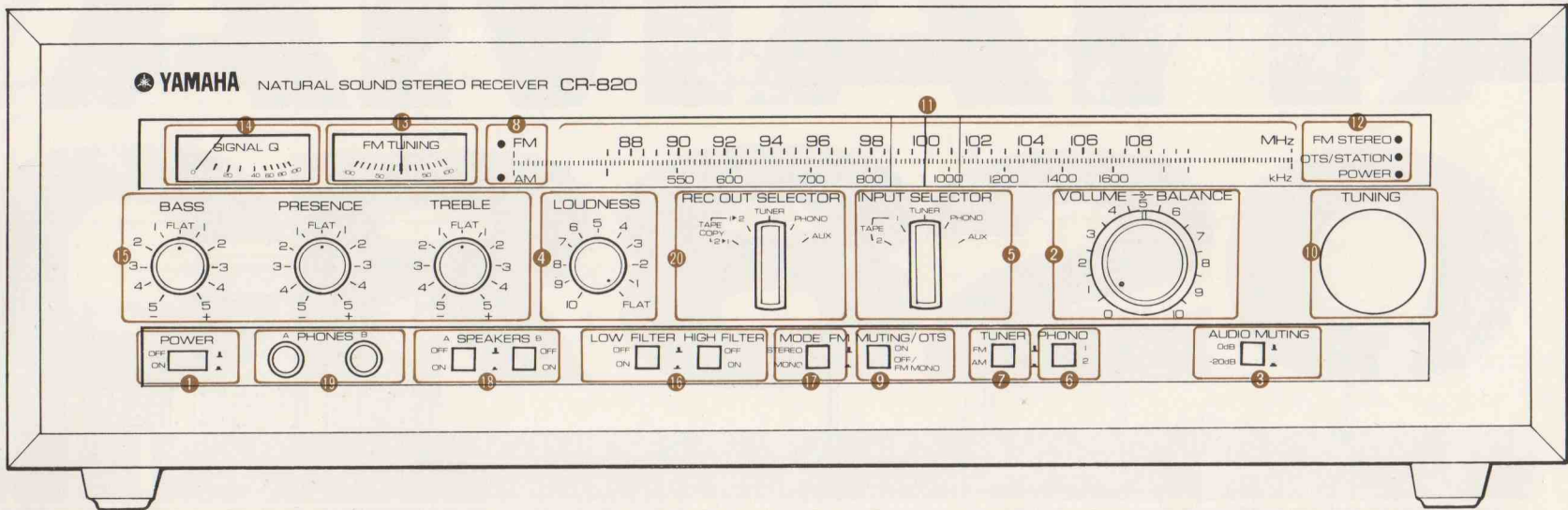

▲ **FRONT PANEL** Front panel numbers are explained on pages 6 and 7.

▼ **REAR PANEL** Rear panel numbers are explained on pages 8 and 9.

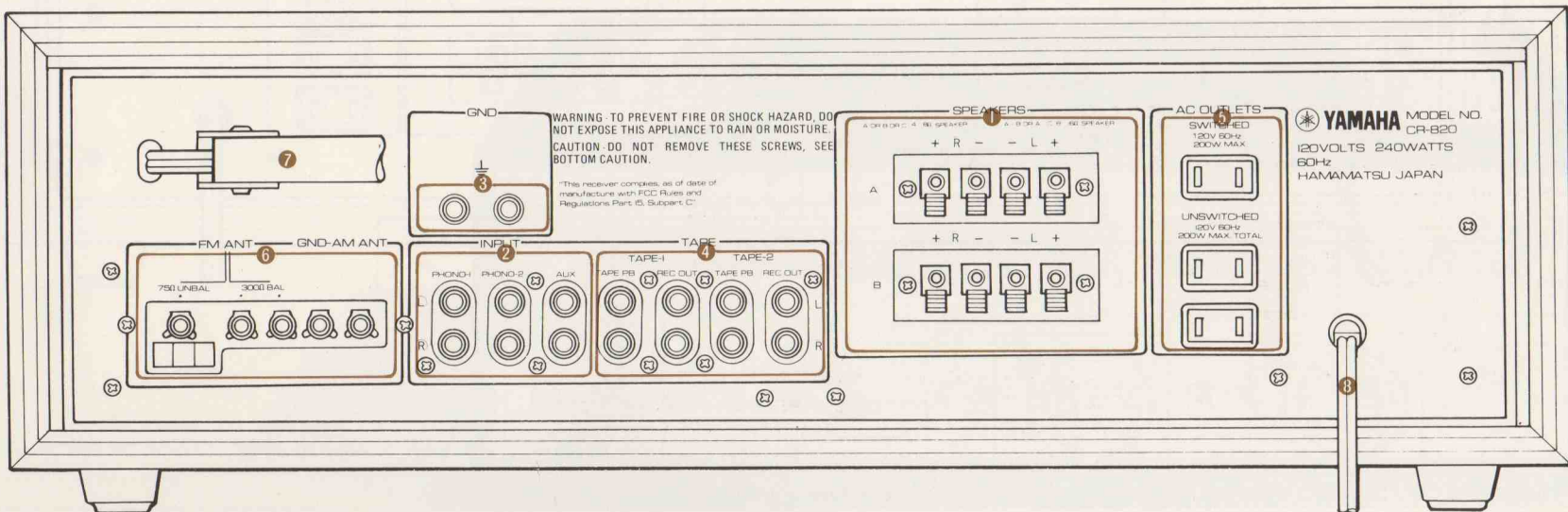

CR-820

CONTENTS

YAMAHA offers you thanks and congratulations on your choice of the CR-820 Receiver. Embodying novel and useful features, it combines superb broadcast reception with the finest audio quality, and is currently setting new standards for receiver performance in its class.

Front Panel and Controls	6
Rear Panel and Connections	8
Broadcast Reception	10
Listening to Records	13
LOUDNESS, FILTER, and TONE Controls . .	14
The Special REC OUT Selector Switch	15
Tape Playback and Recording	16
Block Diagram	18
Circuit Diagram	19
Specifications	20
Trouble Shooting	22

SPECIAL FEATURES OF THE CR-820 RECEIVER

1. All-in-One Excellence

Accurately matched performance specifications, functions, and controls, give overall performance which fully measures up to Yamaha's high tuner, pre- and power amplifier standards.

2. Noise-Distortion Clearance Range

This is the basic concept for the audio section. The CR-820 offers an extremely wide range of output powers for which both noise and distortion are below the rated value, for wide dynamic range in actual use.

3. Direct Assessment of Differential Gain

This sophisticated technique enables Yamaha to combine high station-getting ability, razor-sharp tuning, and ultra-low distortion in the tuner section.

4. Optimum Tuning System (OTS)

The OTS system will take over from you the fine-tuning needed to maintain minimum distortion and maximum stereo separation, so that all FM stereo programs are heard at their best.

5. Twin-Meter FM Tuning with Signal Quality Reading

Both signal strength and center-zero FM tuning meters are provided on the CR-820, with the signal strength meter doubling as a signal quality meter on FM.

6. Comprehensive Tone/Filter Controls

Both Bass and Treble controls have completely 'flat' central positions, and there is also a mid-frequency 'Presence' control. High and Low Filters are also provided.

7. Continuous Loudness Compensation

This Yamaha 'special' enables full compensation for the ears' reduced sensitivity to bass and treble frequencies at low listening levels, whatever your normal maximum listening level.

Warning: to prevent fire or shock hazard, do not expose this set to rain or moisture.

CR-820

CAUTIONS — READ THIS BEFORE OPERATING YOUR CR-820

1

The CR-820 is a high performance AM/FM stereo receiver, with excellent selectivity, sensitivity, low distortion, and high output power. This manual is required reading if you are to get the best from its special features and controls.

2

Do not drop or otherwise jar the CR-820, which is a precision electronic instrument.

3

Do not place the CR-820 where it will be exposed to direct sunlight, excessive heat (for instance over a radiator), cold, moisture, or dust.

4

Do not use chemical solvents (such as benzene or alcohol) to remove traces of dirt. Wipe only with a soft, slightly damp cloth.

5

Do not attempt to carry out internal adjustments or repairs. Leave these to your local service representative.

6

Do not assume your CR-820 is faulty before checking the 'Trouble Shooting' on pages 22 and 23.

8

Note that the muting circuit keeps the CR-820 silent for several seconds after switching ON, to prevent the pops and clicks that can occur.

7

Operate all switches and knobs in accordance with the instructions. Avoid applying undue force, which should never be necessary, and do not attempt to use intermediate settings.

9

Do not connect other audio equipment to the spare AC outlet sockets on the rear panel if it will require more power than the outlets are rated to provide.

Note: AC outlets are not provided on Australian models.

10

Always check the main VOLUME setting before returning the AUDIO MUTING switch to the 0 dB position. The sudden increase in level is enough to damage most speakers if the original level was too high.

11

Keep this manual in a safe place for future reference, and refer to it frequently until you are perfectly familiar with all CR-820 controls and functions.

12

Before switching on your CR-820, check that the voltage selector is set to your local supply voltage. Setting positions are 110/120/130/220/230 or 240 V AC.

Note: Voltage selector is not provided on the U.S. and Canadian models.

The Australian model is fixed for 240 V AC.

CR-820

FRONT PANEL AND CONTROLS

1 POWER ON/OFF Switch

Switch ON to connect the main electrical supply. Leave OFF while familiarizing yourself with the controls, and while connecting other audio equipment.

2 VOLUME and BALANCE Controls

Use the VOLUME control to give the volume of sound that you require. Always start with it turned fully to the left (counter-clockwise) at the '0' position before turning it up to the volume level you require.

The BALANCE controls the difference in volume between the L and R (left and right) stereo channels. Set it to the center '5' position, at which there is a click stop, unless you need to correct for a lack of balance between the channels or for an unsymmetrical listening position. It reduces the volume from the left-hand speaker when turned clockwise, and that from the right-hand speaker when turned counter-clockwise.

3 AUDIO MUTING 0 dB/-20 dB Switch

This offers an instant reduction of 20 dB in level without needing to touch the VOLUME control. It should be used whenever switching between different program sources, when raising and lowering the cartridge stylus in record audition, and when the level must be cut to answer the telephone, etc. Do *NOT* release it to the 0 dB position if you are listening at normal volumes: the sudden increase of 20 dB might be enough to damage your speakers.

4 LOUDNESS Control

This boosts the extreme low and high frequencies to compensate for our ears' reduced sensitivity to these frequencies at low volumes. Set it to the FLAT position while the VOLUME control is set to your highest normal listening level. Turning it counter-clockwise will reduce the volume but retain the natural balance between low and high frequencies.

5 INPUT SELECTOR Switch

This switch is used to select the program source of your choice, whether PHONO, TUNER, one of two TAPE decks, or AUX (for 8-track tape cartridge playback, etc).

6 PHONO 1, 2 Switch

This push-button switch is used to select PHONO terminals 1 or 2 once the INPUT SELECTOR switch has been set to PHONO. The PHONO 1 and 2 positions offers a choice of two phono inputs, both of which are designed for use with normal moving magnet (MM) type cartridges.

7 TUNER FM/AM Switch

This determines whether AM (medium waveband) or FM stations will be received.

8 FM/AM LED Indicators

These light-emitting diode indicators located at the left of the tuning scale indicate whether the TUNER FM/AM switch has been set at FM or AM.

9 FM MUTING/OTS:

ON-OFF/FM MONO

With this switch in the ON position, the Optimum Tuning System (OTS) will minimize the effect of mis-tuning, and will ensure continued optimum reception of FM stations. In the OFF/FM MONO position, accurate manual tuning is essential, and only monaural FM reception will be possible. Even in the ON position, however, OTS is automatically switched off when you touch the tuning knob, permitting manual tuning. The FM MUTING function ensures that both inter-station noise and weak signal strength stations will be muted. In the OFF/FM MONO position even the weakest stations will be heard, but only in the monaural mode.

10 TUNING Knob

This large tuning knob gives smooth and positive station selection, with precision flywheel mechanism.

11 FM/AM Tuning Scale

The upper scale gives FM station frequencies in MHz and the lower scale gives AM frequencies in kHz, with the LEDs 8 indicating which scale is in use.

12 LED Indicators

These light-emitting diodes give visible indication of whether the POWER is on, indicate whether an FM stereo station is being received, and whether the OTS is on.

13 FM TUNING METER

This is used when tuning in FM stations: the indicator points to dead-center when the station is perfectly in tune.

14 SIGNAL Q Meter

This indicates the signal strength for both AM and FM stations, and indicates FM interference by fluctuating, the amplitude of the fluctuation indicating the extent of the interference.

15 BASS, PRESENCE, and TREBLE Controls

In addition to normal bass and treble controls, there is PRESENCE control of the mid-frequencies. In the FLAT (central) positions, the frequency response is completely flat.

16 LOW and HIGH FILTER Switches

The LOW filter gives sharp, 12 dB/octave, cut-off

below 25 Hz. The HIGH filter has the same cut-off slope at frequencies above 10 kHz.

17 MODE Switch

This gives the choice of stereo or monaural reproduction.

18 SPEAKERS A/B

These push-buttons select either or both of two pairs of stereo speakers (or neither, for headphone listening).

19 PHONES A/B Jacks

Two headphone sockets are provided under the plastic protector. Plugging in does not mute the speakers, so use the OFF positions of the SPEAKERS push-buttons.

20 REC OUT Selector

This selects the program source which will be recorded, just as the INPUT SELECTOR selects which program source will be heard. In the CR-820 you can listen to one program source while recording any other (copy a friend's tape while listening to FM, etc).

CR-820

REAR PANEL AND CONNECTIONS

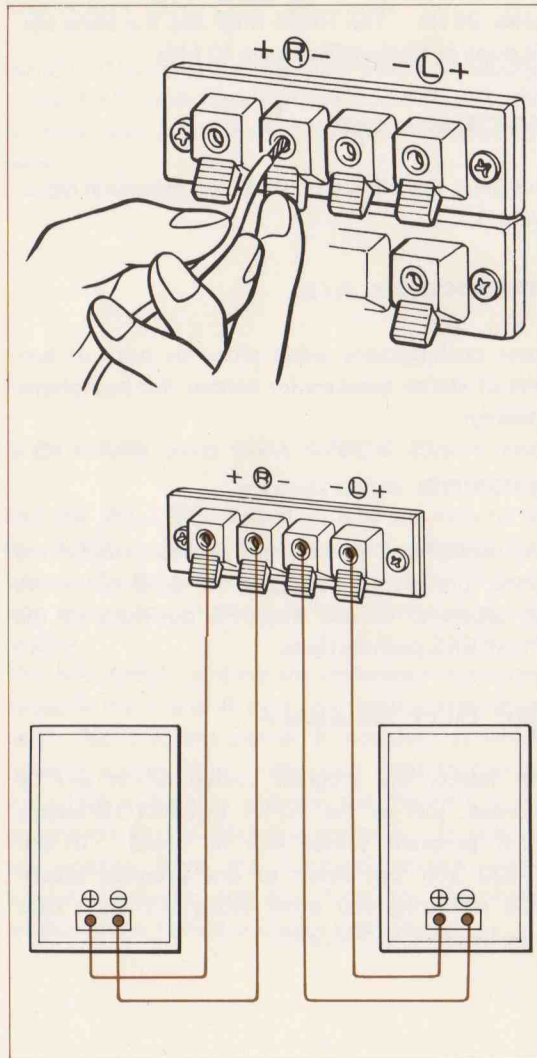

1 SPEAKERS Terminals

The CR-820 can handle two sets of speakers (A or B), with selection of either, both, or neither, by the SPEAKERS push-buttons on the front panel. Speakers should have impedances between 4 and 16 ohms, but with two speaker sets being used at the same time, connect only 8 to 16 ohm speakers. Use speakers rated to take the full 50 Watts of output power, or set the VOLUME control so that the rated maximum speaker input power is not exceeded. Volume level should be reduced immediately increased distortion or a sense of strain indicate that speakers are being overloaded.

Making the Speaker Connections

1. Strip insulation from the speaker cable for 1/2" (10 mm), twist stray ends together. If possible, solder the ends. Push the lever beneath the terminal as shown in the diagram, and align the inner and outer terminal holes. Then insert the wire fully home. Release the lever, and the wire end will be firmly clamped.
2. Use the upper (A) terminals first. Be careful that the terminals identified by the + and - signs above them are connected with the corresponding + and - terminals on the speakers. A mistake will result in poor bass response and ill-defined stereo image. Also be sure to connect the left-hand speaker to the L speaker terminals, and the right-hand to the R terminals.

3. Repeat this with the B terminals if other speakers are to be connected. In all cases make sure that connections are fully and firmly made, or you may not be able to get any sound from one or more speakers.

2 INPUT Terminals

These are the terminals selected by the INPUT SELECTOR switch and PHONO push-button on the front panel. Use the PHONO 1 terminals first, keeping PHONO 2 as a spare. The shorting plugs in the PHONO 2 terminals should be left in place unless these terminals are used. The AUX terminals can be used to connect an external tuner, or for 8-track cartridge tape playback, etc.

3 Ground (GND) Terminal

This ground terminal is provided for the grounding of turntable units, etc. Please make sure that all such units are firmly grounded: failure to connect the ground leads can result in unpleasant hum.

4 TAPE PB and REC OUT Terminals

Two tape decks can be attached to these input and output terminals. Recordings can be made on both at the same time, of any source connected to the CR-820, by setting the REC OUT selector switch on the front panel to the appropriate setting. Tapes can be dubbed from one to the other in either direction, and recording can proceed while any other source selected by the INPUT SELECTOR is being auditioned.

5 AC OUTLETS

These spare AC OUTLETS are provided for your convenience in connecting other items of audio equipment. Only the top outlet is controlled by the CR-820 POWER switch. This has a maximum power rating of 200 Watts, and should be used for items such as turntable units. Do not connect any item which draws more than 200 Watts. The two lower outlets are not affected by the CR-820 POWER switch, and any items connected to them must be switched on and off with their own switches in the normal way. Note that the total power available from these two outlets *together* is only 200 Watts. Use them for, say, your tape deck or decks.

6 Antenna Connections

Detailed instructions on AM and FM reception are given on pages 10 to 12, but a quick check of CR-820 functions can be carried out by connecting the T-type internal (indoor) antenna provided with the CR-820 to the terminals marked 300 Ω BAL. Pin the two arms of the 'T,' fully extended, to the ceiling or walls of your room after finding the best orientation. Note that such a quick check can be carried out with the selector switches vertical and all push-button switches in the out (non-depressed) positions, except for the SPEAKERS A/B buttons if you wish to use speakers rather than headphones.

7 Bar Antenna for AM Reception

This built-in antenna will usually be adequate for satisfactory AM reception. It should be swung away from the rear panel on the hinge provided.

8 AC Electrical Power Line

Just plug into a main power supply wall outlet socket. Make sure the line is not likely to be tripped over.

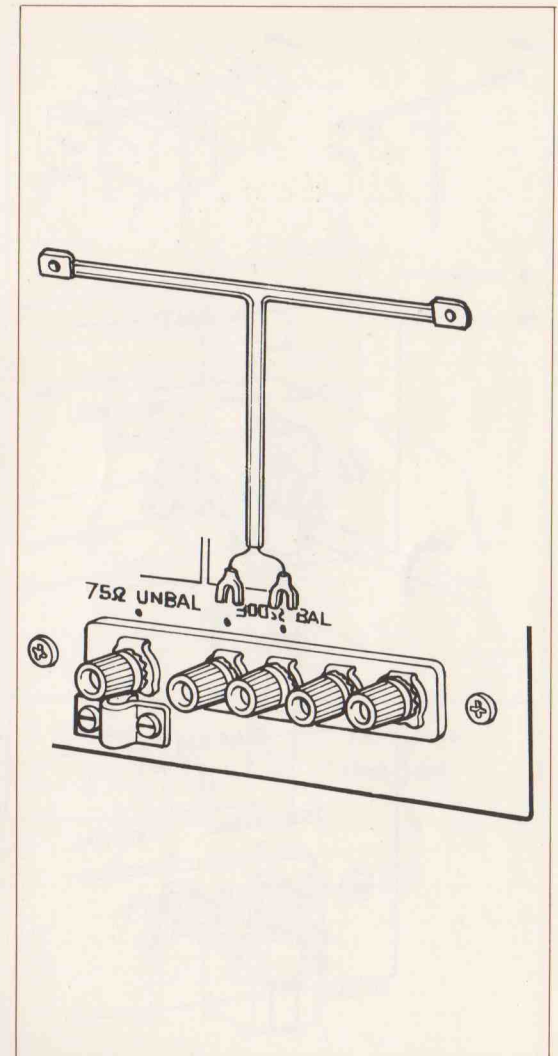

CR-820

BROADCAST RECEPTION

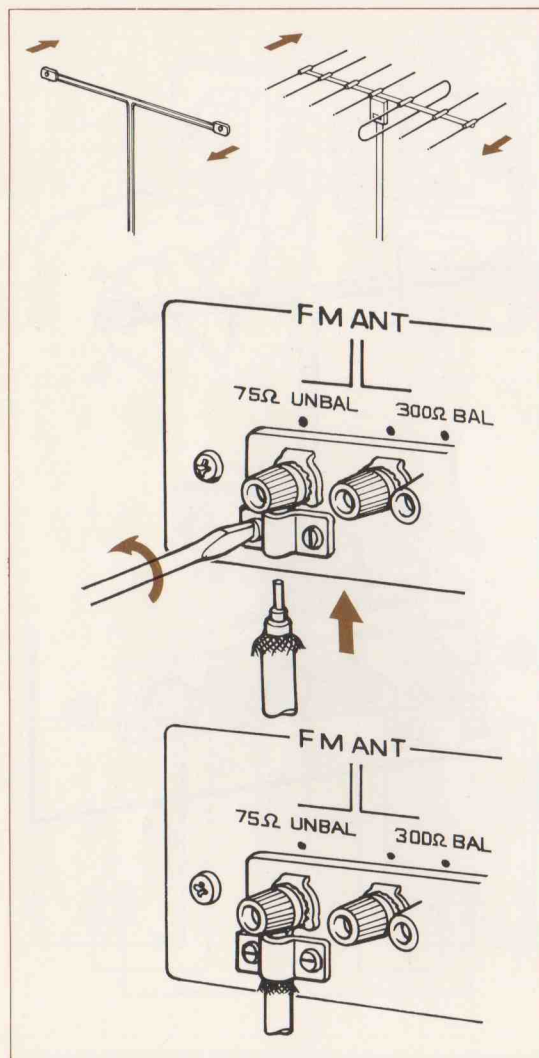

CONNECTING AN FM ANTENNA

The T-type antenna provided is adequate only in high signal strength areas under favorable conditions. In other cases, an external multi-element FM antenna is needed. If you cannot obtain satisfactory reception with the T-type antenna, this is an indication that you need an external FM antenna.

The external antenna should preferably be located fairly close to the CR-820, and mounted as high as conveniently possible. Try various orientations, either pointing towards your weakest station or away from some source of interference (preferably both, although some compromise is usually necessary).

If the antenna is intended for use with shielded coaxial cable (which reduces losses and interference) use the 75 Ω UNBAL terminals, and connect the cable as shown. Antennas intended for the 300 Ω BAL terminals (using feeder wire like that of the internal antenna provided) can also be used with coaxial cable if a matching transformer is fitted to the antenna. Coaxial cable is advisable where the antenna must be located some distance from the CR-820, or where interference from automobile ignition, etc., is troublesome.

CONNECTING COAXIAL CABLE

1. Strip insulation from outside the braided sheath, and bend back the metal braiding *outside* the insulation. Expose the projecting central core wire as shown. Be careful not to cut through any strands.
2. Slacken the two retaining screws as shown, insert the coaxial cable, and re-tighten the screws so that the clip grips the exposed braided sheath.
3. Connect the central core wire to the 75 Ω terminal.
4. Ensure that the braiding does not come into contact with the inner core.

FM BROADCAST RECEPTION

1. Set the INPUT SELECTOR to TUNER, and the TUNER push-button to FM. The FM indicator LED will light.
2. All switches and knobs should be as shown in the front-panel diagram (with all push-buttons OUT except for SPEAKERS A/B as necessary).
3. Touch the tuning knob and note that the OTS/STATION light goes out.
4. Tune for maximum signal strength on the SIGNAL Q meter, ignoring any regular fluctuations.
5. Now tune to bring the FM TUNING meter pointer to the exact center. This is the optimum tuning position: set it carefully. The OTS/STATION light will glow faintly. The FM STEREO indicator will light if the program is in stereo.
6. Release the tuning knob and the OTS/STATION light will glow brightly, indicating that the OTS (Optimum tuning system) will maintain the optimum tuning position.

FM MUTING/OTS, OFF/FM MONO SWITCH

This push-button switch should normally be left in the ON (non-depressed) position. If pushed into the OFF position, it will over-ride the OTS circuits, allowing full manual tuning, but preventing the automatic correction of drift due to temperature and humidity changes.

In the recommended FM MUTING/OTS ON position, the weakest stations will be cut out (muted), with the inter-station noise. You will be able to tune from station to station, free of background noise and remote, very poor quality stations.

If a reduction in noise becomes desirable, press the FM MUTING OTS/ON push-button to the OFF/FM MONO position. You will be able to receive weak stations with the lowest possible noise levels, but only in the monaural mode. Also you will hear the inter-station noise which is normally blanked out by the muting circuit. Use this position when tuning in weak stations very near to much stronger, local stations on the dial.

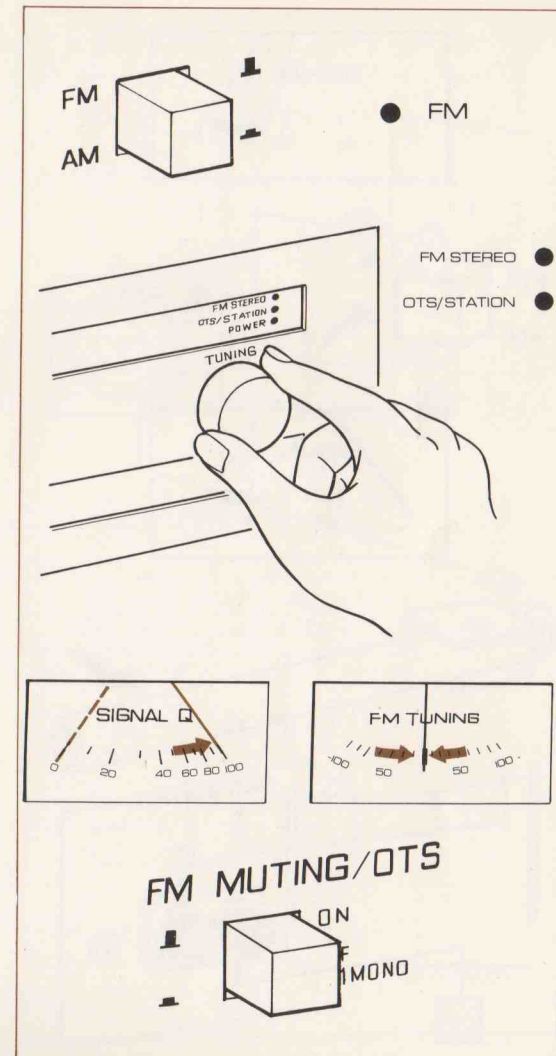

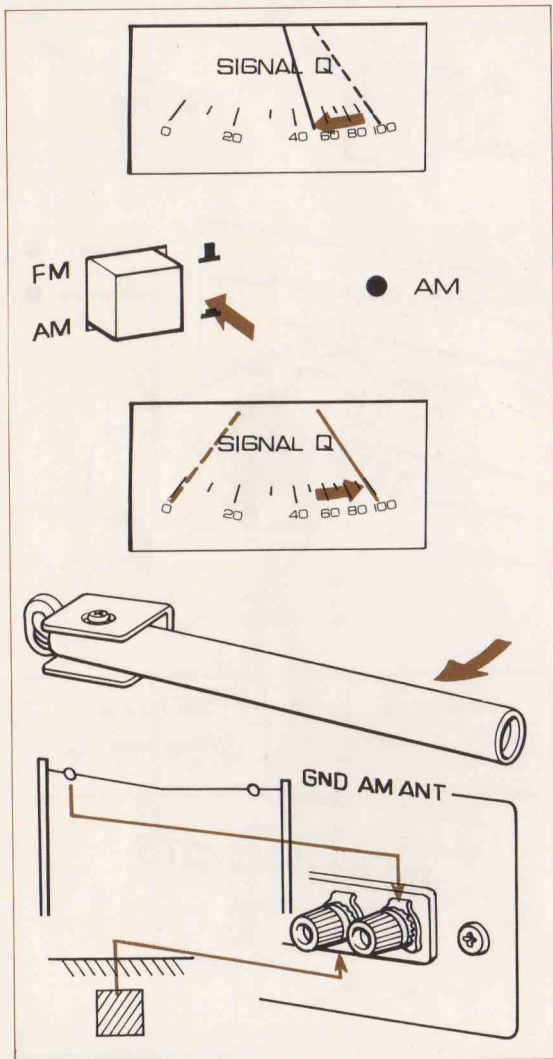

SIGNAL QUALITY

The SIGNAL Q meter, as well as giving an indication of signal strength for AM and FM stations, also gives a visual indication of FM signal quality. When so-called 'multipath' waves (reflected from nearby hills or tall buildings) are present, the meter reading will fluctuate.

If you notice variations in the SIGNAL Q meter readings, try different antenna orientations. You will generally enjoy better tonal quality if you orient the antenna to give a steady reading, even if this level is a little lower than the maximum when the indication is fluctuating.

AM RECEPTION

First set the TUNER FM/AM switch to AM, and set the tuning indicator to the desired station frequency. Adjust the tuning knob to give the maximum SIGNAL meter reading. Note that the FM TUNING meter does not work for AM stations.

AM BAR OR EXTERNAL ANTENNA

The high efficiency ferrite bar antenna provided with the CR-820 is all that is required for satisfactory reception except in low signal strength areas, so that usually no external AM antenna will be needed. The bar antenna should be swung out from the rear panel on the CR-820. Set it at the angle giving the maximum SIGNAL meter reading for the weakest station to which you will normally be listening.

If satisfactory reception cannot be obtained, try connecting an external AM antenna to the AM ANT terminal. A good ground connection (perhaps to a water pipe) will give a further improvement. Do not, however, attempt to use a gas pipe as a ground connection. Your dealer will advise you.

CR-820

LISTENING TO RECORDS

CONNECTING A TURNTABLE UNIT

The main AC supply plug of your turntable unit may conveniently be inserted into the spare AC outlet socket controlled by the CR-820 POWER switch. With some turntable it is important not to disconnect the main supply without first switching off at the turntable itself (read the turntable instruction manual to check). In this case you should use one of the two *unswitched* spare AC outlets. The pin plugs on the output lead from the turntable unit should be connected to the PHONO 1 terminals, keeping the PHONO 2 terminals as spares. Check that the L and R pin plugs (for the left and right channels) have been correctly inserted. Do not forget to connect the turntable ground line to the GND terminal on the CR-820 rear panel.

Switch on the receiver POWER switch, and set the INPUT SELECTOR switch to PHONO. The PHONO switch offers a choice of two positions, PHONO 1 or 2, each of which is intended for use with standard moving magnet (MM), moving iron (MI) or induced magnet (IM) type cartridges.

Certain moving coil (MC) cartridges can also be used, but some have output levels too low for satisfactory performance without the use of a step-up transformer or head amplifier. Note that the PHONO input pin-plugs should never be connected or disconnected while the POWER switch is ON.

Use the AUDIO MUTING push-button switch to cut the volume instantly by 20 dB while changing records and lowering or raising the cartridge, or altering the PHONO switch, etc., without having to turn down the volume each time.

If you play monaural records, the signal-to-noise ratio will be improved if you turn the MODE selector to the MONO position.

If you notice a low-pitched rumble when playing records, cut this out with the LOW filter. Similarly you can use the HIGH filter to reduce unpleasant surface noise or record 'scratch.' Use the BASS, TREBLE, and PRESENCE controls to give the best tonal balance, and use the LOUDNESS volume control to reduce listening levels below your normal maximum, not the main volume control.

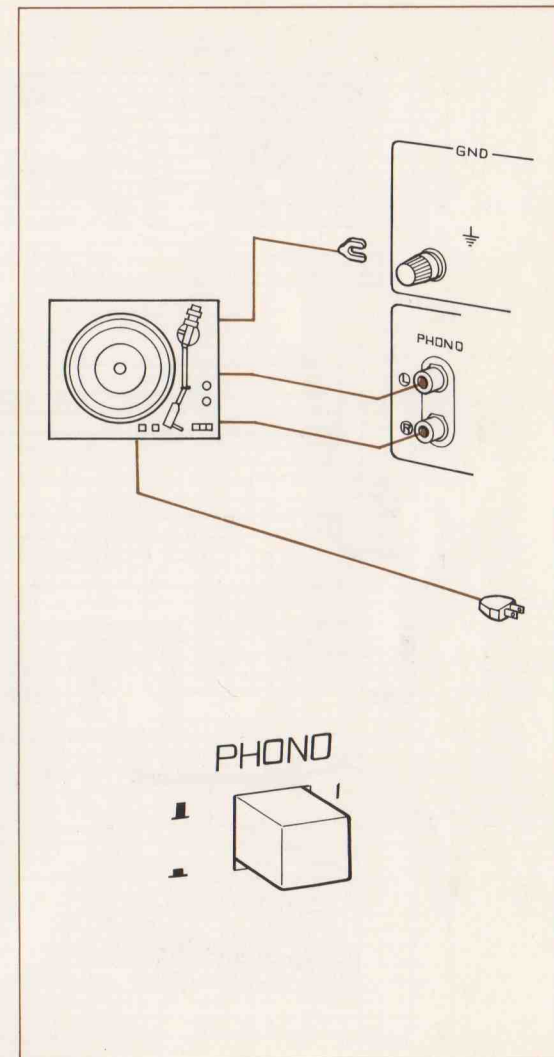

CR-820

LOUDNESS, FILTER, AND TONE CONTROLS

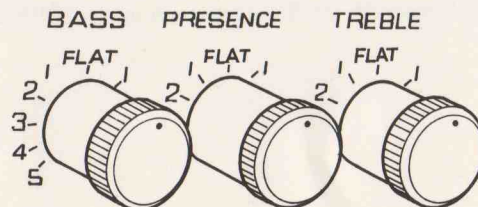
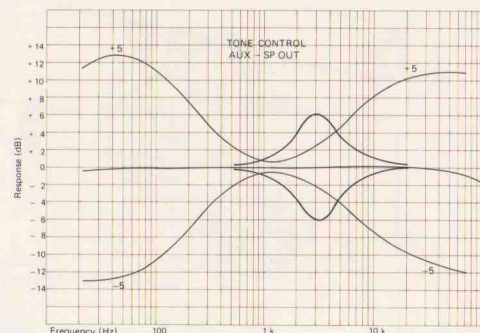
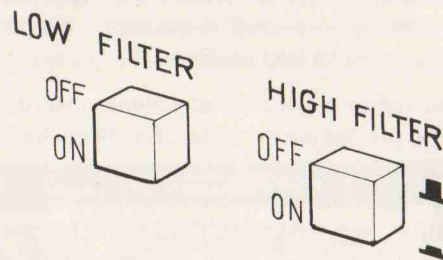
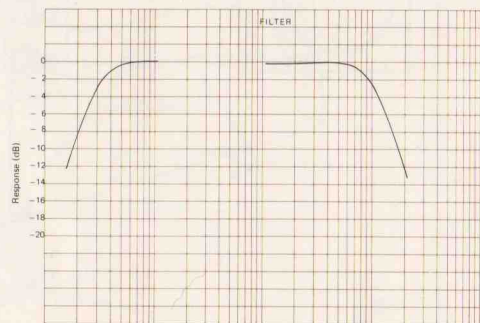
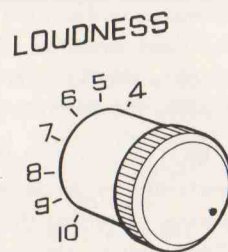
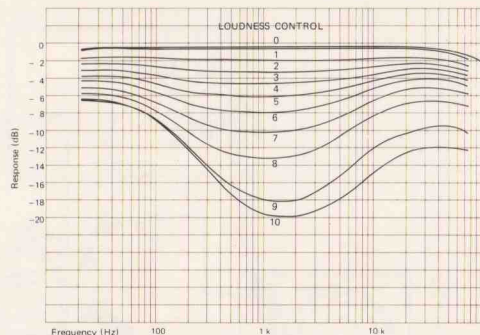

CONTINUOUS LOUDNESS CONTROL

Set this to the *FLAT* position (not the mid-point '5') when listening at normal high levels. The LOUDNESS compensation curves shown enable the same subjective tonal balance to be retained as this control is turned down, unlike the VOLUME control itself, for listening at lower levels.

HIGH AND LOW FILTERS

Sharp, 12 dB/octave cut-offs and low distortion ensure minimum tonal degradation in the important frequencies which carry most of the musical signal. These filters effectively remove sub-sonic rumble and high frequency tape hiss or record surface noise.

COMPREHENSIVE TONE CONTROLS

The carefully chosen turnover frequencies of the bass and treble tone controls give optimum influence at the higher and lower frequencies for major correction of tonal character. The PRESENCE control, centered about 3 kHz, readily compensates for mid-range characteristics. The FLAT position for each control functions as a DEFEAT position, with completely flat response.

CR-820

THE SPECIAL REC OUT SELECTOR SWITCH

INDEPENDENT AUDITION AND RECORDING

Do not confuse the REC OUT SELECTOR and INPUT SELECTOR switches. The INPUT SELECTOR switch decides which program source you hear. The REC OUT SELECTOR switch decides which one you record. Yamaha receivers are at present unique in offering independent choice of audition and recording. Thus you can listen to a record while tape recording direct from the AM/FM tuner section, or while dubbing from one tape recorder to another (set the INPUT switch to PHONO and the REC OUT to TUNER, TAPE 1 ► 2, or TAPE 2 ► 1 positions). Alternatively, you can tape record a disc while listening to, say, an FM broadcast or a music tape played back on a second tape deck (but be careful that you do not infringe copyright laws in tape recording proprietary material). Just set the REC OUT switch to PHONO and the INPUT switch to TUNER or TAPE (1 or 2) respectively.

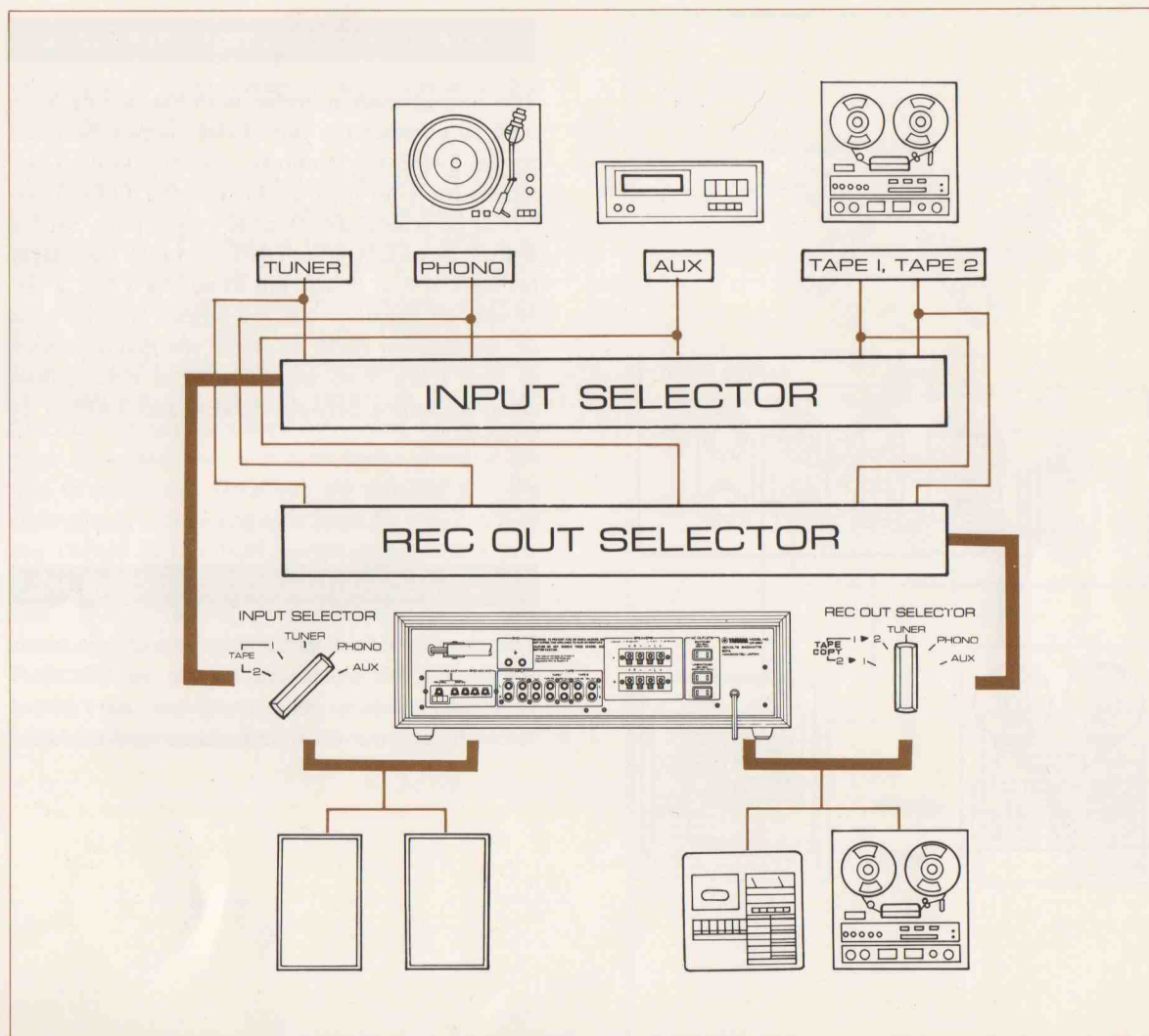

CR-820

TAPE PLAYBACK AND RECORDING

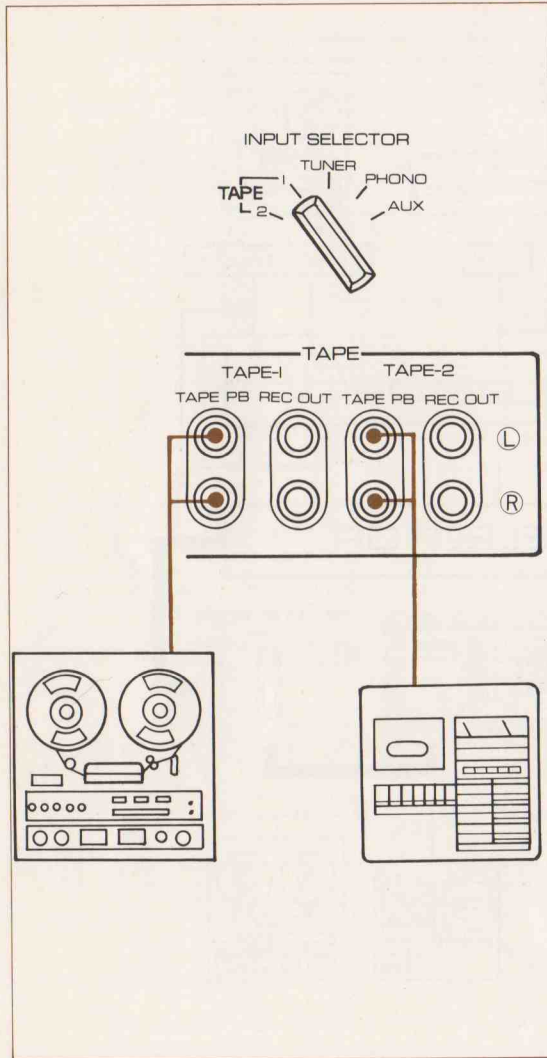

TAPE DECK CONNECTIONS/PLAYBACK

The output leads provided with the tape deck are used to connect the deck LINE output terminals to the TAPE PB terminals. Use the TAPE 1 terminals for your main deck. Use the TAPE 2 terminals for a second deck or as a spare pair. Set the INPUT SELECTOR to TAPE 1 to play back tapes (or to TAPE 2 if you are using the TAPE 2 terminals, of course). Use the output level controls on the deck or decks to adjust the playback level so that there is no great change in volume level when switching between TUNER and TAPE 1 or 2 terminals.

TAPE DECK CONNECTIONS/RECORDING

The tape-deck leads provided are used to connect the deck LINE input terminals to the REC OUT terminals. Again, you should use the TAPE 1 terminals for your main deck, keeping the TAPE 2

terminals for a second or spare pair. Note that the INPUT SELECTOR switch setting has *no effect whatever* upon the signal which will be recorded via these terminals. The REC OUT terminals' signal is decided by the REC OUT selector switch.

If you refer to the description of the REC OUT function on the previous page you will see that recording of any of the program sources connected to the CR-820 is possible: just set the REC OUT switch to TUNER, PHONO, or AUX, respectively.

Recording of any of these sources can proceed while that source, or any other, is selected for audition by the INPUT SELECTOR switch.

Monitoring of the recording while it is in progress can also be carried out if you are using a three-head deck designed for monitoring. Just set the INPUT SELECTOR switch to the TAPE position (1 or 2) via which you are recording. (Note: most cassette tape decks have only two heads, and monitoring is impossible; most open-reel decks do have three heads, with one for monitoring.)

The level at which a recording is made is very important: for full details of recording technique you should consult the manual provided with your tape deck. Adjustments in level must be made with the input level controls on the tape deck.

Note that the signals from the REC OUT terminals which are recorded by your tape deck are not influenced at all by settings of the tone, filter, and volume controls, etc., and all such tonal and other adjustments must be made on playback. If you record at too low a level you will notice a high level of tape 'hiss' on playback, and if the level is too high, the peak volume levels will be distorted and you may even have difficulty in erasing them later.

TAPE TO TAPE DUBBING

For this you will need two decks. Make the connections to the PB and REC OUT terminals for TAPE 1 and TAPE 2 as explained above. If there is a difference in the quality of the decks, better

results will often be obtained if the better deck is used for the recording. Check by making brief recordings in both directions and comparing the resulting quality.

Check carefully that the L (left) and R (right) channel pin-jacks are correctly connected before commencing. To copy a tape from TAPE 1 to TAPE 2 terminals, use the TAPE 1 ► 2 setting on the REC OUT selector switch. Similarly, to copy from TAPE 2 to TAPE 1, use the TAPE 2 ► 1 setting. In both cases you can compare the original recording and the copy by switching the INPUT SELECTOR between the TAPE 1 and TAPE 2 settings (provided that you have decks which allow you to monitor). Once you are satisfied that the recording is proceeding satisfactorily, you can turn the INPUT SELECTOR switch to any other program source you wish to enjoy, and the recording will not be affected. If one or both of the tape decks is not provided with an automatic shut-off function, you should watch carefully for the end of the tape to prevent strain on the drive mechanism and capstan assembly.

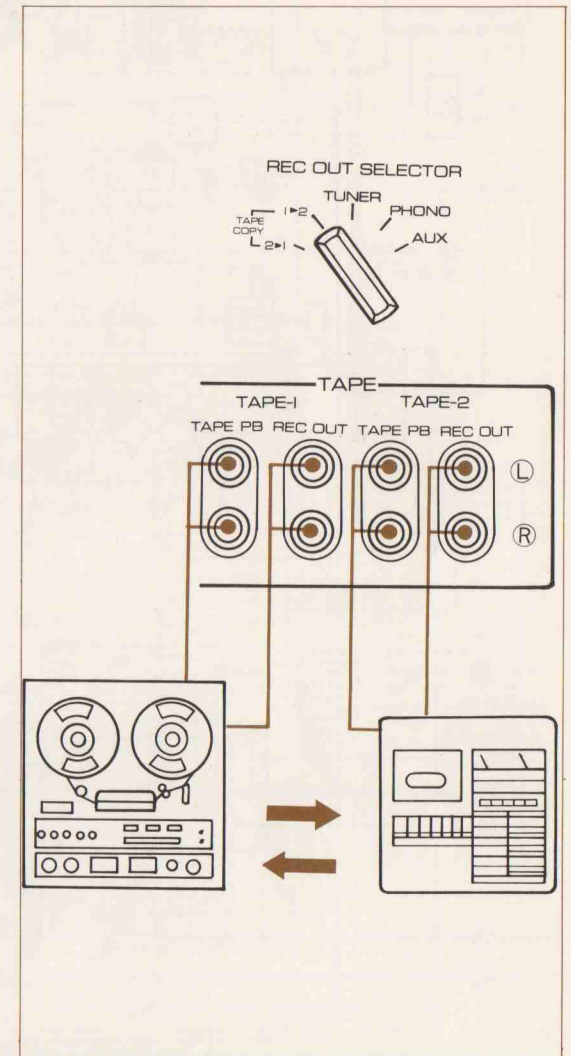

CR-820

BLOCK DIAGRAM

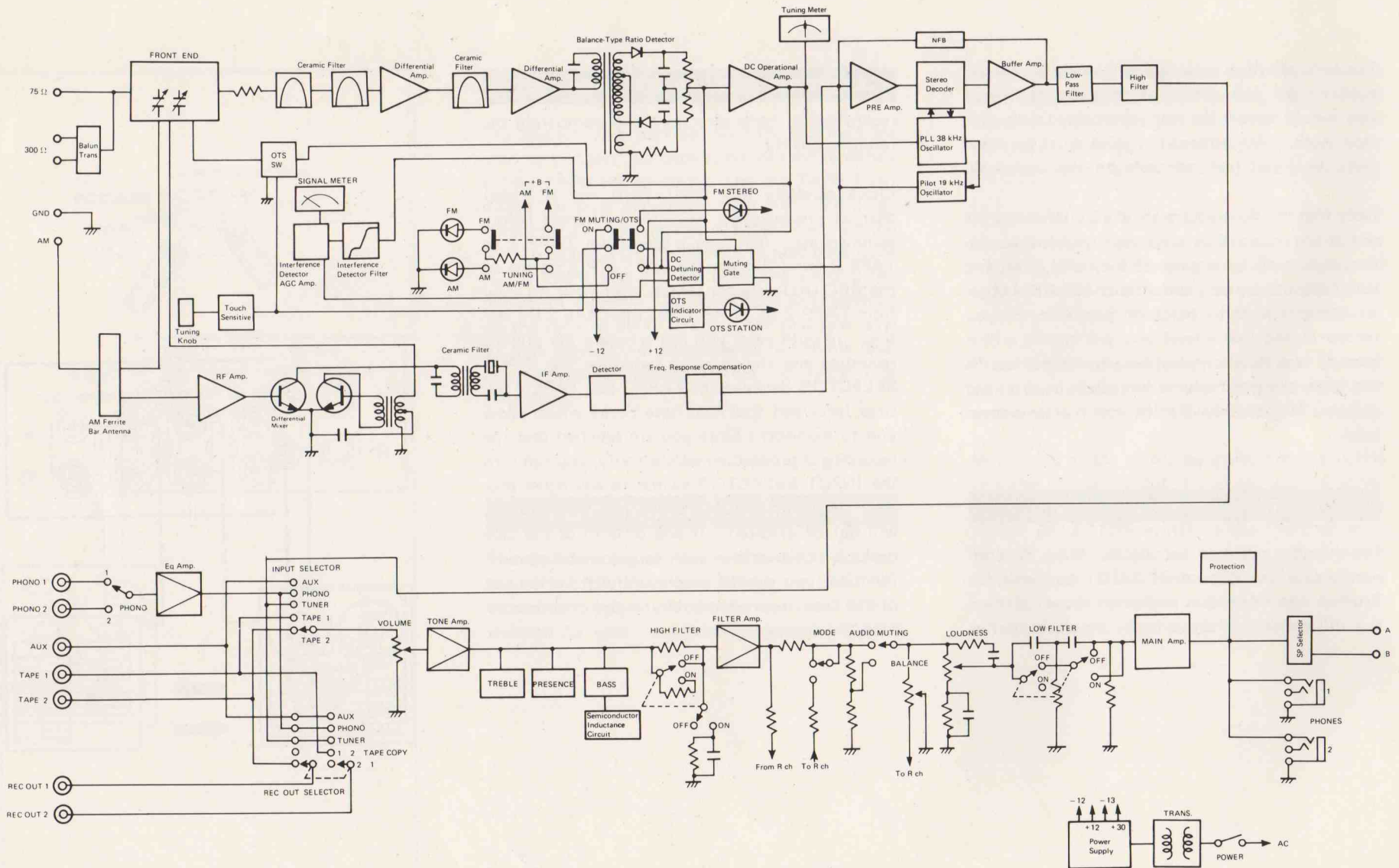

CR-820

CIRCUIT DIAGRAM

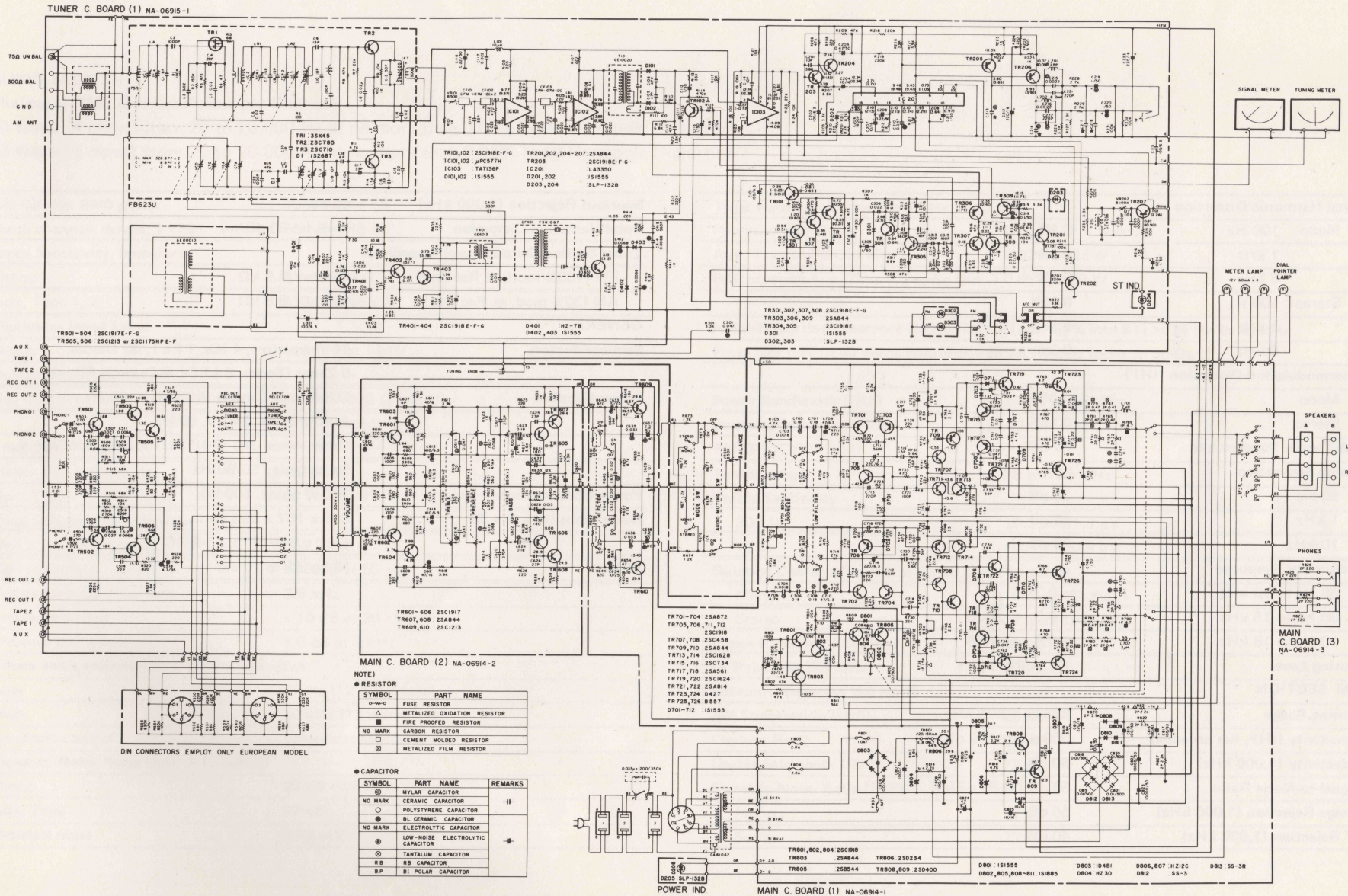

CR-820

SPECIFICATIONS

AUDIO SECTION

Minimum RMS Output Power per Channel

60 Watts (4 ohms) from 20 to 20,000 Hz at no more than 0.05% Total Harmonic Distortion

50 Watts (8 ohms) from 20 to 20,000 Hz at no more than 0.05% Total Harmonic Distortion

Continuous RMS power	70 Watts (4 Ω)
(both channels driven, 1 kHz)	55 Watts (8 Ω)
Input Sensitivity/Impedance	
Phono	2 mV/50 k Ω
Aux, Tape 1, 2	120 mV/45 k Ω
Maximum Input Level	
Phono	120 mV at 1 kHz
Output Level/Impedance	
Rec Out terminals (Phono)	120 mV/220 Ω (rated)
	7.2 V (max. 1 kHz)
Frequency Response	
Phono RIAA deviation	\pm 0.5 dB
Aux, Tape 1, 2 to Sp Out	20 Hz to 20 kHz \pm 0.5 dB
Tone Control Characteristics	
Bass turnover frequency	350 Hz
Bass boost/cut	\pm 13 dB at 50 Hz
Treble turnover frequency	3.5 kHz
Treble boost/cut	\pm 10 dB at 20 kHz
Presence boost/cut	\pm 6 dB at 3 kHz
Filters and Loudness Control Characteristics	
Low	25 Hz (12 dB/octave)
High	10 kHz (12 dB/octave)
Loudness control	Level-related equalization
Signal-to-Noise Ratio (IHF-A Network)	
Phono	92 dB (for 10 mV, short)
Aux, Tape	97 dB
Residual noise	0.12 mV

Total Harmonic Distortion 20 Hz to 20 kHz

Phono to Rec Out	0.012% 2 V output
Aux, Tape to Sp Out (8 Ω)	0.02% at 25 W
IMDistortion Aux, Tape 1, 2 to Sp Out	0.05% at 50 W

Noise-Distortion Clearance Range (NDCR) for 0.1% into 8 Ω at 20 Hz to 20 kHz

From 100 mW to 50 Watts with Vol -20 dB (Phono Input to Sp Out)

Power Bandwidth (IHF) 10 Hz to 50 kHz

Damping factor (at 1 kHz) 40 into 8 Ω

FM SECTION

Tuning range 88 to 108 MHz

Usable Sensitivity

300 Ω 10.3 dBf/1.8 μ V

75 Ω 10.3 dBf/0.9 μ V

Quieting Characteristics (for 50 dB signal-to-noise)

Mono 15.3 dbf (3.2 μ V)

Stereo 37.3 dBf (40 μ V)

Image Rejection (98 MHz) 85 dB

IF Rejection (98 MHz) 90 dB

Spurious Rejection (98 MHz) 100 dB

AM Suppression (IHF) 65 dB

Capture Ratio 1.0 dB

Usable Selectivity (IHF) 75 dB

Signal-to-Noise Ratio (IHF)

Mono 77 dB

Stereo 73 dB

Total Harmonic Distortion		
Mono	100 Hz	0.1%
	1 kHz	0.1%
	6 kHz	0.2%
Stereo	100 Hz	0.15%
	1 kHz	0.15%
	6 kHz	0.3%
Intermodulation Distortion (IHF)		
	Mono	0.05%
	Stereo	0.15%
Sub-Carrier Suppression		60 dB
Stereo Separation		
	50 Hz	30 dB
	1 kHz	40 dB
	10 kHz	30 dB
Frequency Response		
	50 Hz to 10 kHz	± 0.3 dB
	30 Hz to 15 kHz	+ 0.5 -1.0 dB
	10 Hz to 18 kHz	+ 0.5 -3.0 dB
Muting Level		19.2 dBf (5 μ V)
AM SECTION		
Tuning Range		525 to 1,605 kHz
Sensitivity (IHF, bar antenna)		300 μ V/m (49 dB/m)
Selectivity (1,000 kHz)		30 dB
Signal-to-Noise Ratio		50 dB (at 80 dB/m)
Image Rejection (1,000 kHz)		55 dB
IF Rejection (1,000 kHz)		40 dB

Spurious Rejection (1,000 kHz)	55 dB
Total Harmonic Distortion	0.4% (at 80 dB/m)
Tuner Section Output Level/Impedance	
FM (100% mod. at Rec Out)	450 mV/6.5 k Ω
AM (30% mod. at Rec Out)	120 mV/6.5 k Ω
GENERAL	
Semiconductors	74 Transistors, 4 ICs, 1 FET, 30 Diodes, 5 Zener Diodes, 5 LEDs, 4 Ceramic Filters
Power Supplies	U.S.A. and Canada AC 120 V, 60 Hz Australia AC 240 V, 50 Hz Other Areas AC 110/120/130/220/230/240 V Switchable; 50/60 Hz
Power Consumption	240 W (Aust. 400 W)
Dimensions (W x H x D)	508 x 167 x 395 mm (20" x 6-9/16" x 15-9/16")
Weight	13 kg (28 lb 10 oz)

Before assuming that your CR-820 is faulty, check this trouble-shooting list. It details many steps you can take yourself without having to call a service representative.

AUDIO SECTION

Fault	Cause	Cure
No power although POWER switch in ON (POWER LED unlit).	AC power line not plugged into supply socket. AC main fuse has blown.	Plug firmly into the supply socket. Contact your service representative for a replacement.
No sound although power is connected.	Volume too low. INPUT SELECTOR in wrong position. Input pin plugs incorrectly inserted, loose, or disconnected. Speaker connections faulty. Both SPEAKERS push-buttons non-depressed.	Turn up volume. Check and change as necessary. Check and insert fully in the correct positions. Check and make good. Depress one or both (A, B, or A + B).
Sound comes only, or mainly, from either L or R speaker.	Speaker connections faulty. Input connections faulty. BALANCE control not properly adjusted.	Check and make good. Check and make good. Set to give correct stereo balance.
Sound suddenly ceases during audition.	The protective circuit has gone into operation. AC main fuse has blown.	Check for incorrect (too low) speaker impedances or short circuits and correct. If the fault persists, switch off and wait briefly before switching on again. Contact your service representative for a replacement.
Poor bass response and badly defined stereo image.	Speaker + and - connections are incorrect.	Reverse the connections to one speaker, not both.
A loud 'hum' is heard with, or instead of, the record when attempting PHONO audition.	Either the pin-plugs from the phono cartridge are not firmly plugged into the input sockets, or the braided shielding wire is defective.	Plug in firmly, replacing the defective shielding if necessary. Check and make good the GND (ground) wire connection.
The volume control cannot be raised during record audition without a loud 'booming' noise.	This is caused by feedback of sound from the speakers to the phono cartridge stylus, and is called 'howling.'	Increase the separation between turntable unit and speakers, avoiding locations directly in line with the speakers.
Bass and treble frequencies are unnaturally exaggerated.	The LOUDNESS volume control is set too low.	Turn to the FLAT position (fully clockwise) and reset main and LOUDNESS volume controls according to the instructions.
Your tape recorder does not record the program you are monitoring.	The REC OUT selector is not set to the required program source.	Turn to the required setting.

TUNER SECTION

Fault	Cause	Cure
A persistent hum occurs when an AM station is tuned.	This modulation hum can affect whole areas where conditions are unfavorable.	Sometimes changing the position of the CR-820 will give an improvement.
Intermittent crackling or continuous background 'roaring' on AM.	Atmospheric electricity or electrical storms, possibly fluorescent lighting or other electrical equipment.	Difficult to eliminate, an external antenna and good ground connection will give considerable improvement.
High pitched whistles, etc., particularly at night on AM.	Signals from adjacent stations are interfering with reception. The CR-820 is being operated too near a TV set.	Nothing can be done to cut out this interference completely but try the HIGH filter. Increase the separation between the TV and the CR-820.
The desired station cannot be received at the correct frequency on the dial.	The station strength may be low, and the MUTING circuit may therefore prevent audition.	Switch the FM MUTING from ON to OFF.
A stereo station is heard monaurally.	The amplifier MODE switch is set to MONO. The FM MUTING switch is at OFF.	Push and release to the STEREO position. Switch it ON.
Occasional crackling interference (particularly with remote, weak signal stations).	Electrical noise from automobiles, etc., or from other electrical equipment.	Set up an external FM antenna, as high and as far from the road as convenient: use coaxial cable. Fit an interference suppressor to the offending item where possible.
Disturbing levels of 'hiss' noise when on FM stereo stations.	FM stereo broadcasts are inherently more liable to this at remote, low signal strength locations.	Set up an external FM antenna; if you are already using one, orient it towards the station or replace with a more sensitive array. Alternatively or additionally, listen with the FM MUTING/OTS switch set at OFF/FM MONO.
Local stations suffer from unclear, distorted sound.	Signal input from the antenna for these stations is too strong.	Connect an attenuator between the FM antenna and the CR-820, or turn the antenna away from the strongest (closest) station.
During stereo test transmissions, sounds which should come from only one channel can be heard faintly over the other.	This is known as crosstalk, and normally occurs to some extent.	Provided the sound level is very faint compared with the normal level for that channel, no fault is indicated.

TROUBLE SHOOTING



SINCE 1887



YAMAHA

NIPPON GAKKI CO., LTD. HAMAMATSU, JAPAN